



Entergy Services, Inc.  
639 Loyola Avenue  
P. O. Box 61000  
New Orleans, LA 70161-1000  
Tel 504 576 2984  
Fax 504 576 5579  
[hbarton@entergy.com](mailto:hbarton@entergy.com)

Harry M. Barton  
Sr. Counsel  
Legal Department -- Regulatory

October 6, 2017

**Via Hand Delivery**

Lora W. Johnson, CMC  
Assistant Clerk of Council  
Room 1E09, City Hall  
1300 Perdido Street  
New Orleans, LA 70112

*Re: Application of Entergy New Orleans, Inc., for Approval to Construct Distributed Generation-Scale Solar Photovoltaic Systems and Request for Cost Recovery and Related Relief*

Dear Ms. Johnson:

Enclosed please find an original and three copies of the Application of Entergy New Orleans, Inc. ("ENO") for Approval to Construct Distributed Generation-Scale Solar Photovoltaic Systems and Request for Cost Recovery and Related Relief. This filing includes the Direct Testimony and Exhibits of Mr. David A. Owens, Mr. Seth E. Cureington and Mr. Orlando Todd. Please file an original and two copies into the record in the above-referenced matter, and return a date-stamped copy to our courier.

In connection with ENO's filing, certain Exhibits supporting the Direct Testimony of David A. Owens, Seth E. Cureington, and Orlando Todd, as well as the Testimonies of Mr. Owens and Mr. Todd, contain information considered by ENO to be proprietary and confidential. Public disclosure of certain of this information may expose ENO and its customers to an unreasonable risk of harm. Therefore, in light of the commercially sensitive nature of such information, these exhibits bear the designation "Highly Sensitive Protected Materials" or words of similar import. The confidential information and documents included with the Application may be reviewed by appropriate representatives of the Council and its Advisors pursuant to the provisions of the Official Protective Order adopted in Council Resolution R-07-432 relative to the disclosure of Highly Sensitive Protected Materials. As such, these confidential materials shall be exempt from public disclosure, subject to the provisions of Council Resolution R-07-432.

Should you have any questions regarding the above matter, please don't hesitate to contact me at 504-576-2984.

RECEIVED  
OCT 06 2017  
BY: 

OCT 06 13

Ms. Lora W. Johnson, CMC

October 6, 2017

Page 2 of 2

Thank you for your assistance with this matter.

Sincerely,

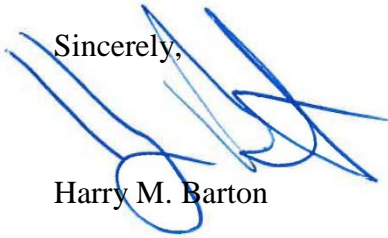

Harry M. Barton

HMB/bkd

Enclosures

cc: Honorable Jason Rogers Williams (*via electronic mail and U.S. Mail*)  
Honorable Stacy S. Head (*via electronic mail and U.S. Mail*)  
Honorable Susan G. Guidry (*via electronic mail and U.S. Mail*)  
Honorable LaToya Cantrell (*via electronic mail and U.S. Mail*)  
Honorable Nadine M. Ramsey (*via electronic mail and U.S. Mail*)  
Honorable Jared C. Brossett (*via electronic mail and U.S. Mail*)  
Honorable James Austin Gray, II (*via electronic mail and U.S. Mail*)  
W. Thomas Stratton, Jr. (*via electronic mail and U.S. Mail*)  
Pearlina Thomas (*via electronic mail and U.S. Mail*)  
Rebecca Dietz (*via electronic mail and U.S. Mail*)  
Clinton A. Vince, Esq. (*via electronic mail and UPS*)  
Presley R. Reed, Jr., Esq. (*via electronic mail*)  
Emma F. Hand, Esq. (*via electronic mail*)  
Walter J. Wilkerson, Esq. (*via electronic mail and UPS*)  
J. A. Beatmann, Jr. (*via electronic mail and UPS*)  
Joseph A. Vumbaco, P.E. (*via electronic mail and UPS*)  
Joseph Rogers (*via electronic mail*)  
Errol Smith, CPA (*via electronic mail and UPS*)

**BEFORE THE  
COUNCIL OF THE CITY OF NEW ORLEANS**

<b>APPLICATION OF ENTERGY NEW</b>	)	
<b>ORLEANS, INC. FOR APPROVAL TO</b>	)	
<b>CONSTRUCT DISTRIBUTED</b>	)	
<b>GENERATION-SCALE SOLAR</b>	)	
<b>PHOTOVOLTAIC SYSTEMS AND</b>	)	<b>DOCKET NO. UD-17-__</b>
<b>REQUEST FOR COST RECOVERY</b>	)	
<b>AND RELATED RELIEF</b>	)	

**APPLICATION OF ENTERGY NEW ORLEANS, INC. FOR APPROVAL  
TO CONSTRUCT DISTRIBUTED GENERATION-SCALE SOLAR PHOTOVOLTAIC  
SYSTEMS AND REQUEST FOR COST RECOVERY AND RELATED RELIEF**

Entergy New Orleans, Inc. (“ENO” or the “Company”) respectfully submits this Application to Construct Distributed Generation (“DG”)-Scale Solar Photovoltaic (“PV”) Systems and Request for Cost Recovery and Related Relief (the “Application”) to the Council of the City of New Orleans (the “Council”). In support thereof, the Company represents as follows:

**INTRODUCTION**

**I.**

ENO is a corporation duly authorized and qualified to do business in the State of Louisiana, created and organized for the purposes, among others, of manufacturing, generating, transmitting, distributing, and selling electricity for power, lighting, heating, and other such uses; and ENO is engaged in the business thereof in the City of New Orleans.

**II.**

Through this Application and supporting testimony, the Company requests approval of its plan to construct multiple DG-scale solar PV systems (the “Project”) with a total combined capacity of approximately 5 MW<sub>AC</sub> in the City of New Orleans. The Project resulted from the 2016 Renewables Request for Proposals (“RFP”), and was one of three resource proposals

selected by ENO from the RFP. The stated objectives of the RFP were to evaluate and potentially procure renewable resources that could provide cost-effective supply, fuel diversity benefits, and other potential benefits to ENO’s customers. The three resource proposals selected from the RFP were the Project, a proposed 20 MW ground-mounted solar PV facility to be located in Orleans Parish that ENO would acquire upon completion (the “Build-Transfer project”), and a proposed 20 MW ground-mounted solar PV facility to be located outside of Orleans Parish from which ENO would purchase the energy produced under a 20-year power purchase agreement (“PPA”). ENO’s Application only seeks Council Approval of the Project as negotiations have not yet been completed for the other two solar PV resource proposals selected from the RFP.<sup>1</sup>

### **III.**

In order to meet the RFP requirements, each individual solar PV system comprising a portion of the Project must be at least 100 kW<sub>AC</sub>. Additionally, the systems will all be located on rooftops at sites within Orleans Parish and will interconnect at distribution voltage (less than or equal to 13.2 kV) on ENO’s side of the host site’s electric meter(s). The Project will utilize rooftops of existing buildings and properties, including customer-owned sites that will be secured under long-term leases and one ENO-owned site (the Dwyer Road service center). Siting the solar PV systems comprising the Project on large rooftops provides economies of scale, allows for locally-sited PV systems despite a lack of suitable and affordable land in Orleans Parish (due, among other things, to wetlands, soil conditions, and zoning requirements)

---

<sup>1</sup> As described in a presentation made to the Council on July 26, 2017, attached to the Direct Testimony of Seth E. Cureington as Exhibit SEC-5, negotiations with counter-parties for the PPA and Build-Transfer project will need to be successfully completed for those projects to come to fruition. ENO intends to file separate applications for these projects if successful negotiations are completed.

on which to build ground-mounted solar PV facilities, and does not remove existing available land in Orleans Parish from commerce.

#### IV.

Several important potential benefits of the Project include: 1) helping ENO achieve its commitment to add up to 100 MW of renewable resources; 2) allowing ENO to gain real-world experience with operating and maintaining DG-scale solar PV systems; 3) achieving distribution grid benefits; 4) facilitating opportunities for future energy storage (*e.g.*, battery) investments; 5) providing economic development benefits to Orleans Parish through increased local investment and use of local labor; and 6) allowing ENO to work directly with its customers to help achieve their goals around sustainability and/or carbon reduction.

#### V.

ENO seeks a Council finding that the Project is in the public interest. The Company also requests that the Council approve its cost recovery requests. With this Application, the Company is submitting the Direct Testimonies of Seth E. Cureington, D. Andrew Owens, and Orlando Todd, the purpose of which is summarized as follows:

- **Seth E. Cureington** – Mr. Cureington, Director, Resource Planning and Operations for ENO, describes the 2016 Renewables RFP, the process undertaken therein, and the basis for ENO’s selection of the Project. He also discusses the basis for a Council decision that the Company’s Application is in the public interest and, therefore, prudent.
- **D. Andrew Owens**– Mr. Owens is the Director of Regulatory Research for Entergy Services, Inc. (“ESI”). He describes the origins of the Project, the preparation of the self-build proposal for submittal into ENO’s 2016 Renewables RFP, the Project’s estimated cost, and Engineering, Procurement, and Construction (“EPC”) Agreement with the solar development company Brightergy Louisiana, LLC (“Brightergy”). He also discusses the pro forma agreement that will be negotiated and executed between ENO and each host

site to secure the property for the asset's expected life, as well as the many potential benefits of the Project.

- **Orlando Todd** – Mr. Todd is the Finance Director for ENO; he presents the estimated revenue requirement for the Project and the Company's proposal for the recovery of the costs associated with the Project.

### **ENO'S 2016 RENEWABLES RFP**

#### **VI.**

As Company witness Mr. Cureington more fully describes, on March 22, 2016, ESI published a public notice that ENO intended to issue a renewables-specific RFP. The notice provided the expected near-term milestones, a high-level description of why ENO chose to undertake the RFP, the parameters around the types and sizing of renewable resources that the RFP intended to solicit, ENO's intention to submit a 5 MW "self-build" project into the RFP, and noted the engagement of Mr. Wayne Oliver of Merrimack Energy Group Inc. to serve as Independent Monitor ("IM"). To support the 2016 Renewables RFP, ESI also set up a public website on [www.entergy.com](http://www.entergy.com) where all notices were made, draft and final RFP documents were accessible, and prospective bidders could submit comments and questions. Prior to ESI's issuance of the final RFP documents on July 13, 2016, a public bidders' conference was held on June 1, 2016, which was attended by 22 potential bidders. Through this conference and the RFP website, ENO allowed bidders to submit questions and comments on various draft RFP documents prior to the final issuance.

#### **VII.**

Mr. Cureington describes the numerous and extensive measures ENO and ESI implemented as safeguards to ensure that information provided by bidders in response to the

2016 Renewables RFP was kept confidential and not improperly disclosed to, or used by, an employee, consultant, or other ESI representative or any other Entergy competitive affiliate.

### **VIII.**

Several contributing factors motivated ENO to issue the RFP. Most importantly, ENO wanted to determine the availability of renewable resources that could provide cost-effective supply, fuel diversity benefits, and other potential benefits to ENO's customers. Other factors included (i) ENO's commitment, as part of the 2015 Integrated Resource Plan, to conduct a renewables RFP in order to obtain better information on the cost and deliverability of renewable resources in ENO's footprint and the surrounding area; and (ii) ENO's desire to build upon its experience owning and operating renewable resources, which began when ENO constructed a 1 MW ground-mounted solar and advanced Li-ion battery storage project in 2016 at the A.B. Paterson site in eastern New Orleans.

### **IX.**

In order to facilitate the RFP process and meet these multiple objectives, ENO limited qualifying renewable technologies to existing or new resources that would use commercially-proven run-of-river hydroelectric, solar PV, or onshore wind. The RFP also furthered these objectives by stating a preference for resources within the ENO region. Among other things, this preference was stated to provide ENO with specific insight into the costs and feasibility of deploying renewable resources in and around Orleans Parish and because of the benefits of locating generation resources near the load they serve.

### **X.**

ENO initially received 17 proposals representing approximately 325 MW of total capacity. The conforming bids ENO received were all for solar PV resources. With respect to resource diversity among the solar PV bids, only one proposal – ENO's 5 MW self-build project

– involved DG-scale solar PV systems. From these bids, ENO ultimately selected the three proposals described above, which included the Project. ENO made the selections in May 2017.

## **XI.**

As Mr. Cureington more fully describes, ENO attempted to balance a number of objectives when making its selections. On a pure cost comparison basis, based on the pricing submitted into the RFP, the Project is more expensive than the other resource proposals that were selected. However, comparing the three selected resource proposals purely on a \$/kW-yr basis does not provide an “apples to apples” comparison<sup>2</sup> of the projects, nor does it take into account the various potential benefits of the Project, summarized herein and described in detail by Mr. Owens. In addition to those benefits, there are other important considerations to take into account for the locally-sited, rooftop solar PV installations that comprise the Project, such as risk mitigation, the benefits of local investment, and the value of locating resources closer to load.

## **XII.**

The Council should also note that, rather than pursue Council approval of the Project absent any kind of competitive evaluation, ENO did conduct a formal RFP process using an IM and did receive multiple proposals. The Project was the only proposal for deployment of DG-scale solar PV. The Project is also one of only two proposals (the other being the Build-Transfer project) that would site renewable resources in Orleans Parish. Moreover, the IM’s Final Report, which is included with Mr. Cureington’s Direct Testimony as Highly Sensitive Protected Materials Exhibit SEC-2,<sup>3</sup> contained a number of important conclusions that the Council should

---

<sup>2</sup> With regard to cost comparison, the Council should note that aggregated DG-scale solar PV systems built at multiple customer-owned rooftop locations within a congested, urban area will naturally cost more on a \$/Watt basis than a utility-scale, ground-mounted solar PV facility built in a rural area where costs for items such as land, permitting, and property taxes are lower.

<sup>3</sup> ENO has also included a Public version of Exhibit SEC-2 with the Application.



consider. Those conclusions include the following statements concerning the RFP process, which are supported by the thorough and complete Final Report submitted by the IM:

- “ENO undertook a competitive procurement process with oversight by an Independent Monitor designed to ensure all Bidders were treated fairly and equitably. The process was designed based on previous ESI solicitation processes implemented in other states which have implemented formal competitive rules or guidelines;”
- “The ENO solicitation process contain[ed] a number of safe-guards designed to ensure that all proposals were treated fairly and that there was no inherent advantage possible for the self-build option. The IM found that the implementation of the safe-guards instituted in the process exceeded industry standards. Furthermore, the safe-guards were diligently maintained throughout the solicitation process;”
- “ESI treated the self-build option fairly and consistently relative to all other proposals;”
- “In conjunction with the role of the IM throughout the process, in our view the transparency of the process is consistent with, and in some cases exceeds, industry standards for other competitive bidding processes;”
- “The response to the RFP was robust with over 16 times the amount of nameplate capacity proposed relative to the amount requested;”
- “The proposal evaluation models and methodologies were appropriate and reasonable for the cost and risk analysis undertaken by ESI;” and
- “ENO’s solicitation was designed as a nine-month process from issuance of the RFP through final selection. The IM did not find this schedule to be unreasonable and it was generally consistent with the timeframe required for conducting such a thorough two-stage evaluation and selection process. ... While this due diligence process may take additional time to complete, it was not only fair to bidders but was expected that such efforts would result in the selection of viable projects.”<sup>4</sup>

---

<sup>4</sup> See SEC-2 at pgs. 36-38.

## **AN OVERVIEW OF THE PROJECT'S DEVELOPMENT**

### **XIII.**

As Company witness Mr. Owens more fully describes, the Project originated from ESI's Commercial Development and Innovations ("CD&I") organization, which organization is responsible for developing and implementing transformative projects to help modernize operations, incorporate new technology into the grid, and enhance customers' experience with their utility. As part of that mission, CD&I has followed several utilities that have received regulatory approval to pursue utility investments in DG-scale solar PV systems located on customer-owned property.<sup>5</sup> The common thread among these examples is that the utility invests in and operates DG-scale solar PV generators that send 100% of the power to the grid and are located on a customer's property under a long-term agreement or some other type of financial arrangement. As with other utility-owned generation resources, the solar PV assets are included in each utility's rate base and reflected in customer rates in some fashion. In January 2016, Mr. Owens approached ENO about developing a plan along these lines for ENO and in February 2016 ENO approved the development of the self-build proposal that would ultimately become the Project for submission into the RFP.

### **XIV.**

Upon receiving this approval, the first major step was to identify and select a qualified solar development company that could serve as the EPC contractor and assist with developing a proposal for the RFP. To that end, in March 2016, ESI issued a Request for Qualifications ("RFQ") concurrently with the public RFP announcement to find interested and potentially qualified solar development companies that could assist ENO with developing and constructing

---

<sup>5</sup> Examples that focus on commercial and industrial customer locations include Virginia Power, DTE Energy, and Public Service Enterprise Group.

DG-scale solar PV systems. Seven companies responded to the RFQ, which ultimately resulted in the selection of Brightergy. Mr. Owens' testimony describes, at length, the process and criteria that resulted in this selection.

#### **XV.**

The Council should note that, since its founding in 2010, Brightergy has completed more than 1,400 commercial-scale solar projects, making them one of the most experienced commercial solar companies in the United States. Brightergy will provide all project development, design, and project management for the individual solar PV systems and will lead efforts to negotiate host site lease agreements. Brightergy plans to outsource most aspects of electrical work and hire local companies, subject to input from ENO and consistent with long-standing efforts to support diverse suppliers (*i.e.*, minority-, women-, and veteran-owned firms), that meet Brightergy's qualification criteria for structural reviews and installation services. To facilitate local hiring, Brightergy has already begun the qualification process with local electrical contractors and service suppliers.

#### **XVI.**

As part of developing the Project, Brightergy performed an extensive screening analysis of available rooftop sites in the City of New Orleans in order to start developing an inventory of attractive commercial locations for further review. Mr. Owens also describes in detail the three levels of screening undertaken for this analysis. To identify sites that would maximize economies of scale, and to eliminate from the screening sites where interconnection of solar PV systems is not permitted, the screening analyses ultimately honed in on approximately 50 buildings as possible host sites for the Project. An additional step was taken to categorize each of the sites into one of three groups: primary, secondary, or tertiary. This categorization sought to identify the sites that presented the least amount of cost and complexity for installation of

solar PV systems and the interconnection of those systems to deliver energy to the grid.

The project team also met directly with several property owners in the primary and secondary groups. These meetings served two purposes. First, the meetings provided a good opportunity to describe the Project, roles, and potential benefits for a host site and to gauge the host site's interest. Second, they allowed for access to a number of sites to perform suitability assessments of buildings including roof condition, pitch, and potential obstructions. Pictures were also taken of the sites to help refine the desktop evaluations that were being performed.

## **THE EPC AGREEMENT AND LEASES**

### **XVII.**

After ENO selected the Project in May 2017, the Project team was notified and immediately began working in earnest to develop the EPC Agreement with Brightergy. Given that the Project is a first-of-its-kind for ENO, considerable time and effort were involved with developing the EPC Agreement framework, processes, specific terms and conditions, and the various exhibits and attachments to those exhibits. The EPC Agreement, which contains the terms and conditions between ENO and Brightergy governing the Project as well as two Contract Order forms, was executed on October 2, 2017.

The first Contract Order form will be issued following execution of the EPC Agreement for the development services that Brightergy will undertake to further identify, develop, and propose fixed-price, date-certain proposals for sites. The second Contract Order form will be used for the design, permitting, installation, testing, and commissioning of a solar PV system for each individual site. For each individual solar PV system, two separate Contract Orders under the EPC Agreement will be executed for development and related activities and actual construction, respectively. The Company's risk is mitigated by having the option to move forward, or not, with each individual solar PV system's two Contract Orders.

## **XVIII.**

Under the EPC Agreement, Brightergy has principal responsibility for identifying and developing sites and negotiating the commercial lease terms. However, ENO and its legal counsel will certainly be involved during the process. ENO will also have the final say on the terms of the leases and the acceptability of the overall agreement prior to execution.

## **ESTIMATED PROJECT COSTS**

### **XIX.**

Mr. Owens explains the underlying categories of costs that will be incurred to obtain the benefits of the Project. As Mr. Owens discusses in more detail, the final estimated installed cost of the Project is \$14.8 million, the majority of which is the EPC Agreement with Brightergy (\$12.3 million). The \$2.5 million in non-EPC costs includes estimated ESI and ENO direct labor costs, indirect costs, overheads, projected Allowance for Funds Used During Construction, and contingency. The final cost estimate accounts for installing roughly 6.4 MW<sub>DC</sub> in order to yield approximately 5 MW<sub>AC</sub>. To be clear, each individual solar PV system will be designed to maximize the use of available space, energy output (kWh), and capacity (in kW<sub>AC</sub>) while mitigating to the extent possible required interconnection work and associated costs.

### **XX.**

Apart from the EPC costs, three categories of on-going expenses are associated with the Project. The first expense category is costs associated with securing the host sites via lease agreements for the 25 years (or more) that the solar PV systems are expected to operate. The second expense category is the annual monitoring and operations & maintenance (“O&M”) costs of the solar PV systems. The third expense category is local property taxes that ENO may incur on the incremental value of the Project relative to ENO’s other assets. Mr. Owens provides a detailed description of these costs and the basis for the estimates developed for them.

## **COST RECOVERY REQUESTS**

### **XXI.**

ENO requests a Council decision, supported by the evidence and sound regulatory principles, that the construction of the Project is in the public interest and, therefore, prudent. As Mr. Owens explains in his Direct Testimony, there are multiple potential benefits of the Project. Those benefits, however, do not come without a cost. Therefore, ENO also requests that the Council approve the proposed cost recovery treatment, which is discussed by Mr. Todd. As Mr. Todd discusses, the first year revenue requirement consists of operating expenses described in his Direct Testimony and the return of and on rate base, the calculation of which is also explained by Mr. Todd. It is important to note that the return on rate base for the Project will ultimately be determined during the 2018 Combined Rate Case, which will be filed on or before July 31, 2018, as the Council directed in Resolution R-17-504.

### **XXII.**

As Mr. Todd explains, ENO will propose the recovery of costs related to the Project in the 2018 Combined Rate Case. The Project is expected to be placed into service during Period II, or the proformed rate-effective period, of that proceeding. Under the current schedule for the Project, which assumes Council approval in early 2018, all of the individual solar PV systems are expected to be installed by the end of 2018. For any costs of the Project incurred beyond the referenced rate-effective period, ENO expects to request, also as part of the 2018 Combined Rate Case, recovery through an applicable capacity rider and/or any formula rate plan (“FRP”) authorized as a result of that proceeding. Anticipated first-year O&M expenses for the Project would also be proformed into the 2018 Combined Rate Case. Any change in the level of ongoing O&M expenses subject to the rate-effective period of the 2018 Combined Rate Case would be addressed in subsequent FRP proceedings or, in the event an FRP is not adopted following the

next general rate case, in any applicable capacity rider.

### **THE SUNIVA TRADE CASE**

#### **XXIII.**

Mr. Owens explains an important development affecting the entire U.S. solar industry and involving a Georgia-based solar panel manufacturer called Suniva, which filed for bankruptcy in April 2017. Shortly afterwards, Suniva filed a trade complaint under Section 201 of the Trade Act of 1974 with the U.S. International Trade Commission (“U.S. ITC”) alleging unfair trade practices by foreign manufacturers of solar cells and solar modules. The complaint asked for duties on imported cells and a price floor on imported modules. Unlike most trade complaints which are directed at individual nations, the Section 201 complaint and request for relief filed by Suniva would apply to imported cells and solar panels from all foreign countries, which may materially affect the cost of imported solar panels.

#### **XXIV.**

The complaint was accepted by the U.S. ITC on May 17, 2017. The U.S. ITC held a hearing on August 15 and voted 4-0 in an opinion issued September 22, 2017, that injury had occurred. The initial injury determination is likely to play a significant role in the U.S. ITC’s finalizing its decision. Any decision to propose remedies to the White House is due within 180 days of the complaint being effective (*i.e.*, November 13, 2017). The White House will then have up to 60 days (mid-January 2018) to accept, reject, or modify the U.S. ITC’s proposed remedies. The Trump Administration has wide latitude to decide on a course of action and will make the ultimate decision, regardless of what the U.S. ITC determines and recommends.

#### **XXV.**

Depending on the outcome of the case, which is not possible to predict, the Project costs could be affected. If the U.S. ITC recommends, and the Trump Administration accepts or

modifies, remedies that include tariffs and/or minimum price floor provisions on imported solar cells and panels, the cost of the Project could increase, perhaps by a significant amount.

#### **XXVI.**

As Mr. Cureington describes, ENO has taken proactive steps to attempt to insulate one aspect of the Project from this risk. Part of the Project involves constructing a Demonstration Site at the Company's service location on Dwyer Road in New Orleans East. There are a number of benefits of constructing the Demonstration Site, particularly for the early stages of the Project's development, such as (i) providing experience to the Project team on the interconnection process and the City permitting requirements and processes, (ii) allowing Brightergy to establish working relationships with local subcontractors, and (iii) providing a functioning site for other prospective host site owners to visit, which would help to allay concerns prospective hosts may have concerning the effects of solar PV installations on the appearance and structural integrity of their roofs. However, due to the time likely required for a thorough review of the Project through a complete regulatory proceeding before the Council, and the timing of expected action in the U.S. ITC case, it would not have been possible for ENO to receive Council approval of the Project in time to protect the Demonstration Site construction from price risk resulting from the pending U.S. ITC case. But given the importance of the Demonstration Site to the Project's viability and success, ENO decided to give Brightergy approval to perform development and design work for the Site. Receiving ENO's approval within this timeframe allowed Brightergy to dedicate existing solar panels in their inventory to the construction of the Demonstration Site, thereby mitigating U.S. ITC-related price-risk associated with this specific aspect of the Project.

#### **XXVII.**

For the Project as a whole, ENO unfortunately does not have the ability to further



mitigate the risks described above since the other participating sites have not been conclusively identified, nor have systems been fully designed. Until approval from the Council is received, Brightergy is not in a position to secure sufficient additional inventory of panels for solar PV systems that are scheduled to begin construction during 2018. Aside from taking the initial step on the Dwyer Road site, there is little else that Brightergy and ENO are able to do at this time given the U.S. ITC case timeline described above, the timeline required for a full regulatory proceeding before the Council, and the significant uncertainty that the Suniva trade complaint has created for the solar industry as a whole.

### **CUSTOMER BENEFITS AND PUBLIC INTEREST**

#### **XXVIII.**

As Company witness Mr. Owens explains further in his Direct Testimony and as this Application summarizes, the Project offers a number of potential benefits to ENO, the customers that agree to host the equipment, and ENO's four main stakeholders: customers, the local community, employees, and shareholders. The Project's benefits include: (i) offering ENO direct partnership with customers and visible support of renewable energy; (ii) providing customers a long-term hedge against the costs of conventional energy; (iii) allowing host sites economic benefits resulting from long term leases; (iv) increasing local investment in, and use of local labor from, the community; (v) offering employees real world experience with DG-scale solar PV systems; and (vi) giving shareholders new opportunities to invest in the City of New Orleans.

#### **XXIX.**

Through this Application, ENO has submitted testimony and exhibits including the estimates and supporting documentation for the costs of the Project, the majority of which are associated with the EPC Agreement with Brightergy. The benefits associated with the Project

support ENO's decision to construct the Project within its service territory. Company witness Mr. Cureington provides testimony supporting the finding that ENO's implementation of the Project is in the public interest. For all of the reasons described herein, and in the Direct Testimony filed in support of this Application, the Council should find that ENO's implementation of the Project is in the public interest.

### **SERVICE OF NOTICES AND PLEADINGS**

#### **XXX.**

The Company request that notices, correspondence, and other communications concerning this Application be directed to the following persons:

Gary E. Huntley  
Vice President, Regulatory and  
Governmental Affairs  
Entergy New Orleans, Inc.  
1600 Perdido Street  
New Orleans, Louisiana 70112

Timothy S. Cragin  
Brian L. Guillot  
Alyssa Maurice-Anderson  
Harry M. Barton  
Entergy Services, Inc.  
639 Loyola Avenue  
Mail Code: L-ENT-26E  
New Orleans, Louisiana 70113

### **REQUEST FOR CONFIDENTIAL TREATMENT**

#### **XXXI.**

Certain exhibits supporting the Direct Testimony of Orlando Todd, Seth E. Cureington, and D. Andrew Owens, as well as the Direct Testimonies of Mr. Owens and Mr. Todd, contain information considered by ENO to be proprietary and confidential. Public disclosure of certain of this information may expose ENO and its customers to an unreasonable risk of harm. Therefore, in light of the commercially sensitive nature of such information, these exhibits bear the designation "Highly Sensitive Protected Materials" or words of similar import. The confidential information and documents included with the Application may be reviewed by appropriate representatives of the Council and its Advisors pursuant to the provisions of the

Official Protective Order adopted in Council Resolution R-07-432 relative to the disclosure of Highly Sensitive Protected Materials. As such, these confidential materials shall be exempt from public disclosure, subject to the provisions of Council Resolution R-07-432.

**PRAYER FOR RELIEF**

**XXXII.**

WHEREFORE, Entergy New Orleans, Inc. respectfully requests that the Council, subject to the fullest extent of its jurisdiction, grant relief and give its approval as follows:

1. Find that the Company's plan to construct multiple distribution generation-scale solar photovoltaic systems with a total combined capacity of approximately 5 MW<sub>AC</sub> located in the City of New Orleans, serves the public convenience and necessity and is in the public interest, and is, therefore, prudent;
2. Confirm that the Company's investments made pursuant to a public interest determination by the Council are presumed prudent and eligible for recovery from customers, and that the Company will have a full and fair opportunity to recover all prudently-incurred costs of the Project;
3. Authorize ENO: a) to recover costs related to any plant expected to be placed into service during the rate effective period of the general base rate proceeding, which it expects to file before July 31, 2018, as required in Council Resolution R-17-504; b) to recover any costs incurred beyond the referenced rate effective period to through any FRP authorized following the 2018 rate case proceeding or through an applicable capacity rider; and c) to proform into the 2018 general rate case any anticipated first-year O&M expenses for the Project, with any change in the level of on-going O&M expenses being addressed in subsequent FRP proceedings or, in the event an FRP is not adopted following the 2018 general rate case, a capacity rider;
4. Grant a waiver of any applicable requirement to the extent that such a waiver may be required to facilitate approval of the transaction described in this Application; and
5. Order such other general and equitable relief as to which the Company may show itself entitled.

Respectfully submitted,

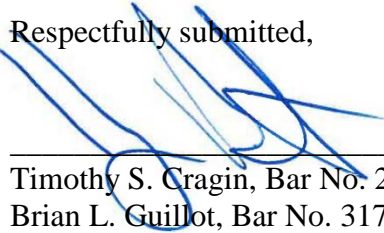

---

Timothy S. Cragin, Bar No. 22313  
Brian L. Guillot, Bar No. 31759  
Alyssa Maurice-Anderson, Bar No. 28388  
Harry M. Barton, Bar No. 29751  
639 Loyola Avenue, Mail Unit L-ENT-26E  
New Orleans, Louisiana 70113  
Telephone: (504) 576-2984  
Facsimile: (504) 576-5579

**ATTORNEYS FOR ENTERGY NEW  
ORLEANS, INC.**

**BEFORE THE  
COUNCIL OF THE CITY OF NEW ORLEANS**

**APPLICATION OF ENTERGY NEW )  
ORLEANS, INC. FOR APPROVAL TO )  
CONSTRUCT DISTRIBUTED )  
GENERATION-SCALE SOLAR )  
PHOTOVOLTAIC SYSTEMS AND )  
REQUEST FOR COST RECOVERY )  
AND RELATED RELIEF )**

**DOCKET NO. UD-17-\_\_**

**DIRECT TESTIMONY**

**OF**

**D. ANDREW OWENS**

**ON BEHALF OF**

**ENTERGY NEW ORLEANS, INC.**

**PUBLIC VERSION**

**OCTOBER 2017**

## **Table of Contents**

I.	INTRODUCTION .....	1
II.	EARLY WORK TO SUPPORT THE PROJECT .....	4
III.	THE SELF-BUILD PROPOSAL .....	11
IV.	PROJECT COSTS AND EPC AGREEMENT.....	17
V.	LEASE AGREEMENT .....	23
VI.	POTENTIAL BENEFITS .....	23
VII.	SUNIVA TRADE COMPLAINT.....	25

## **EXHIBIT LIST**

Exhibit DAO-1	List of previously filed testimony
Exhibit DAO-2	Cost Breakdown (Highly Sensitive Protected Materials (“HSPM”))
Exhibit DAO-3	Engineering, Procurement, and Construction (“EPC”) Agreement (HSPM)
Exhibit DAO-4	Lease Agreement (HSPM)
Exhibit DAO-5	Summary of U.S. ITC Investigation No. TA-201-75

**I. INTRODUCTION**

1  
2  
3  
4  
5  
6  
7  
8  
9  
10  
11  
12  
13  
14  
15  
16  
17  
18  
19  
20  
21

Q1. PLEASE STATE YOUR NAME, TITLE AND CURRENT BUSINESS ADDRESS.

A. My name is D. Andrew Owens. My business address is 639 Loyola Avenue, New Orleans, Louisiana 70113. I am employed by Entergy Services, Inc. (“ESI”) as Director, Regulatory Research.

Q2. WHAT ARE YOUR CURRENT DUTIES?

A. My current role is within ESI’s Commercial Development & Innovation (“CD&I”) organization, which was created about two years ago. The CD&I organization is responsible for developing and implementing transformative projects to help modernize operations, incorporate new technology into the grid, and enhance our customers’ experience with their utility. I am responsible for providing regulatory and policy support to the CD&I organization, as well as to the five Entergy Operating Companies including Entergy New Orleans, Inc. (“ENO” or the “Company”),<sup>1</sup> on initiatives that involve grid modernization as well as new and emerging technologies including distributed generation (“DG”), renewables, energy efficiency and demand-side management (“DSM”), electric vehicles, and micro-grids.

Q3. ON WHOSE BEHALF ARE YOU TESTIFYING IN THIS PROCEEDING?

A. I am testifying in this proceeding before the Council of the City of New Orleans (“CNO” or the “Council”) on behalf of ENO.

---

<sup>1</sup> The five Entergy Operating Companies (“EOCs”) include Entergy Arkansas, Inc.; Entergy Louisiana, LLC; Entergy Mississippi, Inc.; Entergy Texas, Inc.; and ENO.

1  
2  
3  
4  
5  
6  
7  
8  
9  
10  
11  
12  
13  
14  
15  
16  
17  
18  
19  
20  
21  
22  
23

Q4. PLEASE DESCRIBE YOUR EDUCATIONAL BACKGROUND AND PROFESSIONAL EXPERIENCE.

A. In 1991, I earned a Bachelor of Science degree in Chemical Engineering from Iowa State University. In 1998, I was awarded a Master of Science in Management degree from Georgia Institute of Technology (“Georgia Tech”). I am a registered Professional Engineer in Georgia and also have my license as a Certified Public Accountant in Louisiana. Between 1991 and 1996, prior to entering graduate school at Georgia Tech, I worked for an environmental consulting firm that specializes in air pollution issues such as permitting and computer simulations.

After receiving my master’s degree from Georgia Tech, I joined ESI in 1998 and held various roles of increasing responsibility in Sales and Marketing (both regulated and unregulated) and Regulatory Affairs. From early 2000 through the end of 2004, I was employed by Entergy Solutions, Ltd. and was responsible for marketing to the commercial and industrial segments within the Electric Reliability Council of Texas (“ERCOT”) competitive retail market. From 2005 until early 2007, I was responsible for developing new regulated electric sales opportunities in Louisiana. In 2007, I was named Manager, Regulatory Projects for Entergy Louisiana, LLC and was promoted to Director of Regulatory Affairs in April 2009. While serving in that role, I participated in numerous projects involving resource acquisitions, Louisiana Public Service Commission (“LPSC”) rulemakings, and other matters on behalf of Entergy Louisiana, LLC. In January 2014, I assumed the role of Director, Regulatory Policy providing support to all of the Entergy Operating Companies with respect to various regulatory and ratemaking matters. In



1           October 2015, I transitioned to the newly created CD&I organization within ESI as  
2           Director, Regulatory Research.

3

4   Q5.   HAVE YOU TESTIFIED PREVIOUSLY BEFORE THE CITY COUNCIL?

5   A.    Yes. I have included as Exhibit DAO-1 a list of my previously filed testimony.

6

7   Q6.   WHAT IS THE PURPOSE OF YOUR TESTIMONY?

8   A.    I am testifying in support of the Company’s Application, which seeks approval of its plan  
9           to construct DG-scale solar photovoltaic (“PV”) systems (the “Project”) within ENO’s  
10          service area. In my Direct Testimony, I first describe the steps that were undertaken in  
11          early 2016 to evaluate the concepts behind the Project and the work completed to identify  
12          and select a solar contracting company to assist ENO. I then describe the preparation of  
13          the self-build proposal for submittal into ENO’s 2016 Renewables Request for Proposals  
14          (“RFP”). Next, I describe the Project’s projected costs and discuss the EPC Agreement  
15          that has been executed with a solar development company named Brightergy Louisiana,  
16          LLC (“Brightergy”). I then discuss the pro forma agreement that will be negotiated and  
17          executed between ENO and each host site to secure the property for the asset’s expected  
18          life. Finally, I discuss the many potential benefits that the Project can bring to ENO, the  
19          customers that agree to host equipment, and ENO’s four main stakeholders: customers,  
20          the local community, employees, and shareholders.

21

1                                   **II. EARLY WORK TO SUPPORT THE PROJECT**

2   Q7.   PLEASE DISCUSS THE ORIGINS OF THE PROJECT.

3   A.   As part of my role to support the CD&I organization and the five Entergy Operating  
4       Companies as they evaluate new ideas, my team focuses on researching regulatory and  
5       other activities that are proposed and undertaken by peer utilities around the U.S. Over  
6       the past several years, we have followed several utilities that have sought and received  
7       regulatory approval to pursue utility investments in DG-scale solar PV systems located on  
8       customer-owned property. Examples that focus on commercial and industrial customer  
9       locations include Virginia Power, DTE Energy, and Public Service Enterprise Group  
10      (“PSEG”). The common thread among these three examples is that the utility invests in  
11      and operates a DG-scale solar PV generator that sends 100% of the power to the grid and  
12      is located on a customer’s property under a long-term agreement or some other type of  
13      financial arrangement. As with other utility-owned generation resources, the solar PV  
14      assets are included in each utility’s rate base and reflected in customer rates in some  
15      fashion.

16  
17   Q8.   WHEN WAS THE PROJECT FIRST CONCEIVED BY ENO?

18   A.   In late 2015, as the CD&I organization was being ramped up, ENO was simultaneously  
19      finishing its work plan to construct the 1 MW solar + battery project at the A.B. Paterson  
20      site in eastern New Orleans. I was involved in the early efforts to assist ENO with  
21      drafting the 2015 RFP to identify an EPC contractor to build the 1 MW solar + battery  
22      project. To be clear, this was a different RFP from the 2016 Renewables RFP. Once the

1 EPC contractor was selected in 2015, I had less direct involvement as the project moved  
2 towards construction in early 2016.

3 In January 2016, I broached the idea with ENO about the possibility of a project  
4 that would involve the Company constructing and owning DG-scale solar PV systems on  
5 customer-owned sites. As part of several informal brainstorming sessions in early 2016  
6 with ENO's resource planning and regulatory teams, the idea for the Project was  
7 conceived and began to take shape.

8

9 Q9. WHAT HAPPENED AFTER THE PROJECT BEGAN TO TAKE SHAPE?

10 A. In February 2016, I became aware that ENO was considering issuing a renewables-  
11 specific RFP sometime later that year. I discussed the possibility with ENO of evaluating  
12 the Project in conjunction with that renewables RFP, provided that the many details of the  
13 Project could be further defined. At that point in time, the Project was still more of a  
14 concept that would require significant additional work to come to fruition. Nonetheless,  
15 ENO was supportive of undertaking further work to develop the Project such that it could  
16 be bid into the upcoming renewables RFP. On February 25, 2016, ENO's Operating  
17 Committee gave approval to create a Project Team in order to prepare a self-build  
18 proposal for submittal into its forthcoming renewables RFP.

19

20 Q10. WHEN DID ENO FIRST COMMUNICATE THE PROJECT PUBLICLY?

21 A. On March 22, 2016, ENO provided written public notice to prospective bidders that it  
22 would be issuing a 2016 Renewables RFP seeking up to 20 MW of resources and, further,  
23 that a self-build project would be considered. The March 22, 2016, notice stated:

1 As part of the RFP process, ESI would evaluate a self-build generation option, of  
2 up to five (5) MW, for Aggregated Solar PV Facilities to be located within the  
3 ENOI Load Zone. The self-build proposal would be considered and evaluated  
4 against proposals submitted in response to the RFP. Additional details regarding  
5 the self-build option would be included within the RFP documents. ENOI  
6 reserves the right to withdraw the self-build project from participation in the RFP.  
7

8 Q11. PLEASE DESCRIBE THE PROPOSED PROJECT.

9 A. The Project involves constructing multiple solar PV systems with a total combined  
10 capacity of approximately 5 MW<sub>AC</sub> located in the City of New Orleans. In order to meet  
11 the RFP requirements, each individual solar PV system comprising a portion of the  
12 Project must be at least 100 kW<sub>AC</sub>. Additionally, the systems will all be located at sites  
13 within Orleans Parish and interconnected at distribution voltage (less than or equal to 13.2  
14 kV) on ENO's side of the host site's electric meter(s).<sup>2</sup> The Project will utilize existing  
15 buildings and properties, including customer-owned sites that will be secured under long-  
16 term leases and one ENO-owned site (the Dwyer Road service center).  
17

18 Q12. PLEASE DESCRIBE THE INITIAL STEPS THAT WERE UNDERTAKEN BY THE  
19 PROJECT TEAM.

20 A. Once the team had received approval that a self-build proposal could be submitted, the  
21 first major step was to identify and select a qualified solar development company that  
22 could serve as the EPC contractor and assist with developing a proposal for the RFP.

23 In March 2016, ESI issued a Request for Qualifications ("RFQ") concurrently with  
24 the public RFP announcement to find interested and potentially qualified solar

---

<sup>2</sup> As discussed below, certain downtown areas served by network grids are not suitable to host systems.

1 development companies that could assist ENO with developing and constructing DG-scale  
2 solar PV systems. The RFQ was sent to companies that had been identified during earlier  
3 efforts and was designed to narrow the focus to a smaller, more manageable list of  
4 qualified companies.

5

6 Q13. WHO RESPONDED TO THE RFQ?

7 A. Seven companies responded to the RFQ. All of the companies had prior experience with  
8 designing and installing DG-scale, rooftop solar PV systems on commercial and industrial  
9 property. A few of the companies also had prior experience working directly for utilities.  
10 However, a critical aspect of the Project is the ability for the selected solar development  
11 company to identify attractive potential sites and negotiate reasonable commercial terms  
12 on behalf of ENO to secure the site for the asset's expected life. Only a few of the  
13 companies had any prior experience with negotiating such arrangements. Another criteria  
14 that was used in the RFQ evaluation was whether the company had experience with  
15 governmental locations including installing solar PV systems on K-12 schools and  
16 universities, and if so, what educational programs and materials they had developed. The  
17 final criteria involved a high level review of the financial condition of each company.

18

19 Q14. WHAT DECISIONS CAME OUT OF THE RFQ PROCESS?

20 A. Based on the criteria that I describe above, three companies were selected for further  
21 review and consideration.

22

23

1 Q15. WHAT STEPS WERE TAKEN NEXT?

2 A. Beginning in early April 2016 and continuing for roughly two months, several additional  
3 steps were taken to select the EPC contractor. First, each of the three remaining  
4 companies executed a non-disclosure agreement (“NDA”) so that ENO could share  
5 specifics about the Project and the anticipated role of the selected company. Second, a  
6 conference call was held with each company to probe into various aspects of their RFQ  
7 response, provide details about the Project, answer any questions, and address any  
8 concerns that were raised. Third, each company was asked to provide specific details  
9 about how it would undertake its role for the Project, if selected, including how it would  
10 meet all applicable requirements, including being licensed in Louisiana. Finally, each  
11 company was asked to provide a detailed indicative cost break-down, equipment  
12 specifications, and anticipated output for a hypothetical 500 kW<sub>DC</sub> rooftop solar PV  
13 project to be located in New Orleans. The purpose of this aspect of the evaluation was to  
14 understand in more detail the way each company was thinking about costs and whether  
15 each company’s estimated costs included all components and appeared to be reasonable  
16 based on public data about DG-scale solar PV costs.

17

18 Q16. DID THAT PROCESS YIELD ANY ISSUES?

19 A. Yes. First, it became clear early on during the review that one of the three companies still  
20 in contention did not have the scale and full set of capabilities necessary to successfully  
21 perform their role. As such, the Project team shifted its focus towards the two remaining  
22 companies that were still in contention.

23 As the scope of the Project was more clearly defined for the three companies, one

1 of the two remaining companies decided to partner with additional companies. Each of  
2 the partner-companies brought different skillsets applicable to different aspects of the  
3 Project. Initially, the company leading that effort indicated that they would be the “prime  
4 contractor” and that the other partner-companies that were identified in their response  
5 would be sub-contractors underneath them. Under that approach, the EPC agreement and  
6 all of its associated responsibilities would be with the prime.

7 At first, the proposed approach did not raise any concerns as it was expected that  
8 any solar company selected would have to use sub-contractors for certain aspects of the  
9 project (*e.g.*, local electrical contractors and suppliers, local construction labor).  
10 However, one of the requirements to be selected was that the company had to be fully  
11 licensed in Louisiana with the Louisiana State Licensing Board for Contractors. Once the  
12 Louisiana licensing requirement was communicated, the would-be “prime contractor”  
13 company indicated that it was not licensed in Louisiana, nor did it plan to become  
14 licensed; instead, the company indicated that one of their identified sub-contractors  
15 already licensed in Louisiana would switch places with them and function as the prime  
16 contractor. After this company notified the project team that it would be altering the  
17 structure with a new prime, the team requested that the company provide more  
18 information about itself including, for example, recent audited financial statements.

19  
20 Q17. WHAT WERE THE RESULTS OF THE FINAL EVALUATION?

21 A. As I noted above, the efforts by that point were focused on the two remaining companies.  
22 The first company (Brightergy) did not raise any concerns or issues and appeared to have  
23 the scale, capabilities, and experience to successfully undertake the Project. The second

1 company and its identified sub-contractors also appeared to have the capability and  
2 experience for the Project. However, three issues arose with the second company. The  
3 first issue involved the overall structure and concerns about whether adequate controls and  
4 communication protocols could be put in place to effectively manage the project. The  
5 second issue involved the company's financial condition. The final issue involved the  
6 company's track record on safety. Based on the overall evaluation from this phase  
7 including consideration of the three issues that I just described, Brightergy was selected in  
8 June 2016 to assist ENO with the self-build proposal.

9  
10 Q18. PLEASE DESCRIBE BRIGHTERGY AND THEIR ROLE IN THE PROJECT.

11 A. Brightergy was founded in 2010 and is headquartered in Kansas City, Missouri. Since its  
12 founding, Brightergy has completed more than 1,400 commercial-scale solar projects,  
13 making them one of the most experienced commercial solar companies in the U.S.  
14 Brightergy also has a strategic partnership with Black & Veatch, a global leader in EPC  
15 services for energy, water, and telecommunications.

16 Brightergy created a subsidiary (Brightergy Louisiana, LLC) for the Project.  
17 Brightergy will provide all project development, design, and project management for the  
18 individual solar PV systems and will lead efforts to negotiate host site lease agreements.  
19 Brightergy plans to outsource most aspects of electrical work and hire local companies,  
20 subject to input from ENO and consistent with long-standing efforts to support diverse  
21 suppliers (*i.e.*, minority, women, veterans, disabled veterans, HUB Zone), that meet  
22 Brightergy's qualification criteria for structural reviews and installation services. Many  
23 aspects of system design will be completed by Brightergy, which is licensed in Louisiana



1 (License # 63125). To facilitate local hiring, Brightergy has already begun the  
2 qualification process with local electrical contractors and service suppliers.

3

4

### III. THE SELF-BUILD PROPOSAL

5 Q19. WHEN WAS THE 2016 RENEWABLES RFP ISSUED?

6 A. In early May 2016, ESI issued the draft 2016 Renewables RFP documents to the public.  
7 The project team, which at that point included only ESI personnel, began its review of the  
8 public draft documents to ensure (1) that there was a clear understanding of the specific  
9 requirements and (2) whether any of the requirements or templates required further  
10 clarification. While that review was on-going, the separate RFQ process that led to the  
11 selection of Brightergy was being completed. Once Brightergy had been selected, a  
12 Memorandum of Understanding (“MOU”) was negotiated and executed.

13

14 Q20. WHY WAS AN MOU WITH BRIGHTERGY IMPORTANT?

15 A. There are two principal reasons that negotiating an MOU with Brightergy was important.  
16 First, although ESI acting on behalf of ENO had “selected” Brightergy, both parties  
17 expected that it would take significant time to negotiate an EPC agreement, which would  
18 be well past the due date for the self-build proposal (late September 2016). Prior to  
19 execution of the EPC, Brightergy would be expending significant time and resources to  
20 assist with the self-build proposal with no assurance or expectation that (1) the self-build  
21 proposal would be selected from the RFP and (2) that an EPC could be negotiated and  
22 executed if the self-build proposal were selected. Second, the MOU served to formalize

1 the relationship between the parties to prepare the self-build proposal, which helped  
2 clarify roles and responsibilities and mitigate risk on both sides.

3

4 Q21. WERE OTHER ASPECTS OF THE PUBLIC 2016 RENEWABLES RFP PROCESS  
5 OCCURRING IN PARALLEL?

6 A. Yes. On June 1, 2016, a public Bidder's Conference was held at ENO's offices in New  
7 Orleans. The project team made sure that both of the remaining companies that were  
8 under consideration were aware of the event and could send at least one representative.  
9 At that point, the decision in the separate RFQ effort had not yet been made to select  
10 Brightergy. My recollection is that both of those companies attended the Bidder's  
11 Conference. As I noted above, the decision was made to select Brightergy in June 2016.  
12 Shortly after the Bidder's Conference, the Project team submitted written comments on  
13 June 22, 2016, to the RFP Administrator regarding the draft RFP.

14

15 Q22. WHEN WAS THE FINAL 2016 RENEWABLES RFP ISSUED?

16 A. On July 13, 2016, the final RFP documents were issued via the website portal. At that  
17 point, the project team was able to download the various documents and templates to  
18 begin work on the self-build proposal.

19

20 Q23. WHAT STEPS WERE TAKEN TO PREPARE THE SELF-BUILD PROPOSAL?

21 A. There were many steps involved with developing the self-build proposal. Once the final  
22 RFP had been carefully reviewed, the project team set about determining specific roles  
23 and responsibilities for ESI and Brightergy personnel, respectively. One of the first steps

1 taken was for Brightergy to perform a screening analysis of available sites in the City of  
2 New Orleans in order to start developing an inventory of attractive commercial locations  
3 for further review.

4  
5 Q24. PLEASE DESCRIBE THE SCREENING PROCESS.

6 A. The first screening level that Brightergy performed looked at the entire City of New  
7 Orleans. Brightergy used a requirement that the building needed to have a rooftop of at  
8 least 20,000 square feet in size and be three stories or fewer. The relevance of the 20,000  
9 square foot filter was that the RFP set a minimum solar system capacity of 100 kW<sub>AC</sub>.  
10 Roughly speaking, approximately 100 square feet is needed per kW<sub>DC</sub> of capacity. To  
11 account for buffer space and the DC to AC conversion, 20,000 square feet was selected as  
12 a reasonable proxy for a building that would support 100 kW<sub>AC</sub>. Brightergy also included  
13 the downtown network grids in the first screening level, despite those grids' ineligibility  
14 for installing generation. To get a sense of solar capacity, a high level utilization factor of  
15 60% was applied by Brightergy to gross rooftop space to account for age, tilt, potential  
16 obstructions, and/or shading. The results from the first screening level indicated that the  
17 City of New Orleans had approximately 26 million square feet of estimated usable rooftop  
18 space with total potential solar capacity of approximately 260 MW<sub>DC</sub>.

19 The second level of the screening analysis removed the downtown network grids  
20 (Central Business District, Warehouse District, and the French Quarter), where generation  
21 running in parallel with the grid is not permitted per ENO's interconnection policies. The  
22 following map illustrates the portions of the City of New Orleans that were eliminated in  
23 the second screening level.

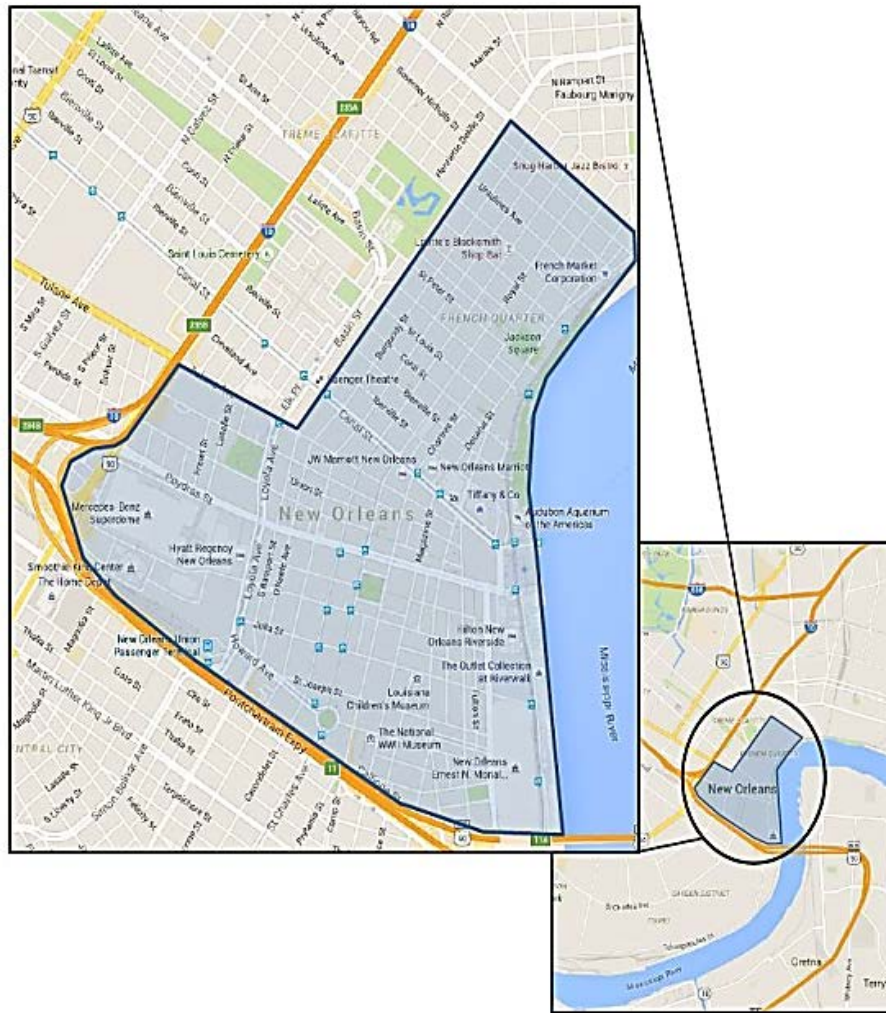

1  
2  
3  
4  
5  
6  
7  
8  
9

After removing the area shaded in the blue, the same 60% utilization factor was used yielding roughly 20 million square feet of potentially suitable rooftop space representing approximately 200 MW<sub>DC</sub> of total solar capacity.

In the third screening level, the criteria were set to all buildings in the City of New Orleans with rooftops of at least 100,000 square feet, three stories or fewer, and excluding the downtown network grid-served areas in order to identify and prioritize larger, suitable properties for the Project. Rather than using the 60% utilization factor from the first two screening levels, each building was evaluated using desktop software like Google Earth.

1 In total, there were approximately 50 buildings that were reviewed. Based on estimating  
2 the amount of solar capacity that each individual building might host, the total estimated  
3 capacity was approximately 45 MW<sub>DC</sub>.

4 An additional step was taken to categorize each of the buildings into one of three  
5 groups: primary, secondary, or tertiary. Primary included warehouses and distribution  
6 centers. Secondary included manufacturing, governmental sites, and “big box” retailers.  
7 Tertiary included sites such as hospitals, K-12 schools, and universities.

8  
9 Q25. WHY DID THE TEAM CATEGORIZE THE LARGER BUILDINGS INTO PRIMARY,  
10 SECONDARY, AND TERTIARY?

11 A. The primary reason for categorizing buildings into three categories described above  
12 relates to cost and complexity. By cost, I mean the actual installed cost of a rooftop solar  
13 PV system. When installing solar on a large warehouse with a flat roof and minimal  
14 obstruction, economies of scale can be realized that are not achievable when factors such  
15 as smaller buildings, tiered roofs, rooftop equipment, or shading are present.  
16 Additionally, by complexity, I mean the time and effort necessary to negotiate and execute  
17 a long-term agreement with the host site. With this being ENO’s first foray into installing  
18 and owning DG-scale solar PV systems, the goal of the team was to reduce installed and  
19 on-going costs as much as possible.

20  
21 Q26. WHAT OTHER STEPS WERE TAKEN RELATED TO POTENTIAL SITES?

22 A. Several additional steps were taken to prepare the self-build proposal. First, the project  
23 team developed a document that would be an attachment to the self-build proposal. The

1 document included the various screening analyses that were performed and described  
2 above; a building inventory including location (latitude and longitude coordinates),  
3 ownership, and high level observations about the roof based on satellite photos; a  
4 preliminary evaluation for each building including a potential rooftop solar PV system  
5 layout and associated capacity; and, an illustrative portfolio of buildings. For the  
6 illustrative portfolio, Brightergy modeled each of the buildings using the PVSyst software  
7 tool to develop overall indicative operating characteristics (*e.g.*, predicted annual energy  
8 output, hourly production shape).

9 The project team also met directly with several property owners in the primary and  
10 secondary groups. The purpose of the meetings was two-fold. First, the meetings  
11 provided a good opportunity to describe the project, roles, and potential benefits for a host  
12 site and to gauge the host site's interest. Second, it allowed the team to access a number  
13 of sites to perform suitability assessments of buildings including roof condition, pitch, and  
14 potential obstructions. Pictures were also taken of the sites to help refine the desktop  
15 evaluations that were being performed.

16  
17 **Q27. PLEASE DESCRIBE THE ELEMENTS OF THE SELF-BUILD PROPOSAL.**

18 **A.** The RFP requested that prospective bidders address numerous specific criteria in  
19 Appendix C-1 (Due Diligence – Developmental) as well as fill out several templates with  
20 basic proposal information and operational data. In addition, Appendix C-1 required  
21 attaching supporting documents and information including the document that I described  
22 addressing potential host sites. An Excel cost model using inputs from Brightergy for the  
23 EPC portion of the Project and various assumptions for the non-EPC portion was also

1 prepared and submitted. All of the proposal elements were delivered to the RFP  
2 Administrator on September 30, 2016.

3  
4 **IV. PROJECT COSTS AND EPC AGREEMENT**

5 Q28. WHAT WAS THE FINAL COST ESTIMATE FOR THE SELF-BUILD PROPOSAL?

6 A. The final estimated installed cost of the Project was \$14.8 million, the majority of which  
7 is the EPC agreement with Brightergy (\$12.3 million). The \$2.5 million in non-EPC costs  
8 includes estimated ESI and ENO direct labor costs, indirect costs, overheads, projected  
9 Allowance for Funds Used During Construction (“AFUDC”), and contingency. The  
10 following provides a summary for each major cost category:

Equipment (modules, inverters, racking, electrical interconnect, and balance of system (BOS) equipment)	
Installation labor	
Professional services (engineering, project management, leasing, corporate overheads, contingency, and fee)	
Miscellaneous (sales tax and performance bond)	
<b>EPC Agreement Sub-Total</b>	<b>\$12.29m</b>
Internal labor, expenses, indirect costs, and interconnections	\$1.31m
AFUDC	\$0.49m
Contingency	\$0.75m
Total estimated project cost	<b>\$14.84m</b>

11 HSPM Exhibit DAO-2 is a more detailed breakdown for the Project. The final cost  
12 estimate was based on installing roughly 6.4 MW<sub>DC</sub> in order to achieve the stated  
13 objective of yielding approximately 5 MW<sub>AC</sub>. To be clear, each individual solar PV  
14 system will be designed to maximize the use of available space, energy output (kWh), and  
15 capacity (in kW<sub>AC</sub>) while mitigating to the extent possible required interconnection work  
16 and associated costs. For example, to the extent possible, existing infrastructure like  
17 transformers will be used rather than upgraded to avoid triggering any added cost. This

1 approach may require that some solar PV systems be sized smaller than the physical space  
2 available would otherwise support or that an inverter be sized smaller than the capacity of  
3 the solar PV modules. Such determinations would be made on a case-by-case basis to  
4 maximize output and minimize cost for each solar PV system.

5  
6 Q29. WHAT DOES THE COMPANY BELIEVE IS AN APPROPRIATE ESTIMATED  
7 ASSET LIFE FOR THE DEPRECIATION PROPOSED FOR THE PROJECT?

8 A. Using a 25-year asset life is appropriate for depreciation purposes due to several  
9 considerations. First, solar panels are typically warrantied for 25 years with other key  
10 components like inverters typically having shorter warranty periods. Second, unlike a  
11 ground-mounted solar PV project that would be expected to have a longer asset life (30  
12 years or more), the longevity of a rooftop solar PV system will be affected by needed  
13 repair and replacement of the roof, which may occur within 25 years of being installed, as  
14 well as the willingness of the host site to allow the equipment to stay in place beyond the  
15 initial term of the lease agreement.

16  
17 Q30. PLEASE DESCRIBE THE EPC AGREEMENT AND ITS DEVELOPMENT.

18 A. As I noted above, the proposal for the Project was submitted into the 2016 Renewables  
19 RFP on September 30, 2016. After ENO selected the Project in May 2017, the Project  
20 team was notified and began working in earnest to develop the EPC agreement with  
21 Brightergy. Given that the Project is a first-of-its-kind for ENO, considerable time and  
22 effort were involved with developing the EPC agreement framework, processes, specific



1 terms and conditions, and the various exhibits and attachments to those exhibits. I have  
2 included a copy of the executed EPC agreement as HSPM Exhibit DAO-3.

3 As far as structure, the EPC blanket agreement contains the terms and conditions  
4 between ENO and Brightergy governing the Project as well as two Contract Order forms,  
5 and was executed on October 2, 2017. The first Contract Order form for a given location,  
6 such as the Dwyer Road Demonstration Site that Company witness Seth E. Cureington  
7 discusses in his Direct Testimony, will be issued following execution of the EPC blanket  
8 agreement for the development services that Brightergy will undertake to further identify,  
9 develop, and propose a fixed price, date certain proposal. The second Contract Order  
10 form will be used for the design, permitting, installation, testing, and commissioning of a  
11 solar PV system for each individual site. For each individual solar PV system, two  
12 separate Contract Orders under the blanket EPC agreement will be executed for  
13 development and related activities and actual construction, respectively. The Company's  
14 risk is mitigated by having the option to move forward, or not, with each individual solar  
15 PV system's two Contract Orders.

16 The blanket EPC agreement contains fixed prices to be applied for Contract  
17 Orders, which are subject to change orders and extra work provisions should  
18 modifications become necessary. This exposure has been mitigated to the extent possible  
19 by broadly defining the scope of work assigned to Brightergy and including everything  
20 necessary to complete the Project that meets the specification and performance  
21 requirements. Under the EPC, Brightergy will pay liquidated damages for delays beyond  
22 the fixed schedule for each individual solar PV system. There are also performance

1 guarantees for output, which include an option for Brightergy to either correct the  
2 deficiency or pay liquidated damages for the shortfall in guaranteed output.

3  
4 Q31. BESIDES THE UPFRONT INVESTMENT GOVERNED BY THE EPC AGREEMENT,  
5 WHAT OTHER COSTS DOES THE PROJECT INVOLVE?

6 A. There are three categories of ongoing expenses associated with the project. The first  
7 expense category is costs associated with securing the host sites via lease agreements for  
8 the 25 years (or more) that the solar PV systems are expected to operate. The second  
9 expense category is the annual monitoring and operations & maintenance (“O&M”) costs  
10 of the solar PV systems. The third expense category is local property taxes that ENO may  
11 incur on the incremental value of the Project relative to ENO’s other assets.

12  
13 Q32. PLEASE DISCUSS THE ESTIMATED COSTS ASSOCIATED WITH SECURING  
14 HOST SITES.

15 A. The Project team estimated the total first year costs associated with securing host sites at  
16 [REDACTED]. Members of the Project  
17 team have met with a number of prospective host sites, but have yet to enter into detailed  
18 negotiations with any party. As such, one of the uncertainties related to the Project is the  
19 actual level of cost that will be incurred securing sufficient host sites. Given the screening  
20 analyses that I described earlier and the number of sites that could host a solar PV system,  
21 I believe that there will be sufficient interest from host sites that ENO can manage this  
22 uncertainty.

23

1 Q33. WHAT ARE THE ESTIMATED COSTS ASSOCIATED WITH MONITORING AND  
2 O&M SERVICES?

3 A. For the self-build proposal, Brightergy provided a cost estimate of [REDACTED]  
4 [REDACTED]  
5 [REDACTED] if they were selected to provide monitoring and O&M services. As noted in the  
6 Direct Testimony of Company witness Orlando Todd, ENO has not yet determined  
7 whether it will outsource monitoring and O&M services or perform those services itself.  
8 It should be noted that equipment warranties (*e.g.*, 25 years in the case of solar panels) and  
9 guarantees will be in place as a backstop.

10

11 Q34. WILL ANYTHING BESIDES ROOFTOP SOLAR BE CONSIDERED?

12 A. Possibly. The primary focus of the Project is to develop and construct utility-owned  
13 rooftop solar PV systems. That said, several prospective host sites have asked if ENO  
14 would consider ground-mounted solar PV systems or a solar PV system mounted on a  
15 parking lot canopy. Thus far, we have communicated to these potential host sites that  
16 ENO will consider ground-mounted and parking canopy solar, but that any incremental  
17 costs (both upfront and ongoing) to the Project would have to be addressed. For example,  
18 it is possible that a host site interested in a parking lot canopy would be willing to pay the  
19 incremental cost in exchange for a lower annual lease payment.

20

21 Q35. PLEASE BRIEFLY COVER THE DISTRIBUTION INTERCONNECTION PROCESS  
22 AND POTENTIAL ASSOCIATED COSTS.

1 A. There are two different interconnection policies that may apply depending on the size of  
2 the generator (one policy covers generators less than 300 kVA and the other covers  
3 generators between 300 kVA and 20 MVA). Both policies use the same application form  
4 and the policies themselves are similar. Generally speaking, the policy in place for a  
5 larger generator seeking to interconnect to ENO's distribution system potentially involves  
6 additional study given possible electrical impacts that may need to be mitigated.

7 The interconnection process for a given site will be initiated by Brightergy  
8 submitting a completed application on behalf of ENO. The two policies contemplate  
9 seven (7) separate cases, with Case 6 being the most applicable to the individual solar  
10 systems that will comprise the Project. Under Case 6, all of the power produced by a solar  
11 PV system will be delivered to the grid.

12 To the extent that additional study is required for a particular site, ENO will not be  
13 required to pay any upfront deposits. In other words, in the event that additional study is  
14 triggered and ENO decides to continue with the review process for a given site, the work  
15 will be performed at ENO's cost and, as is normal practice, actual costs incurred will be  
16 assigned to ENO through the use of a designated project code. A similar interconnection  
17 review process was followed with respect to the Paterson solar + battery project that was  
18 constructed in early 2016 and came on-line last summer. And, to the best of my  
19 knowledge, no additional costs were incurred by ENO related to the interconnection  
20 review process for that project. Nonetheless, as detailed in HSPM Exhibit DAO-2, the  
21 Company has budgeted for the possibility that some interconnection costs will be incurred  
22 to complete the Project.

23

1 **V. LEASE AGREEMENT**

2 Q36. HOW WAS THE LEASE AGREEMENT DEVELOPED?

3 A. As discussed above, prior to selecting Brightergy, ESI looked for solar companies that  
4 could demonstrate experience with negotiating lease terms with host sites. As part of that  
5 review process, ESI requested that each company provide a copy of their standard lease  
6 agreement, which occurred under a non-disclosure agreement. As I noted above, several  
7 companies lacked experience with leasing host sites and did not provide a lease  
8 agreement. ESI's legal group developed the form of lease to be used for ENO's Project  
9 based on Brightergy's standard lease agreement and a lease agreement obtained from  
10 another utility for their similar DG program. I have included a copy of the form lease  
11 agreement in HSPM Exhibit DAO-4.

12  
13 Q37. HOW WILL THE LEASE AGREEMENT BE NEGOTIATED?

14 A. Under the EPC agreement, Brightergy has principal responsibility for identifying and  
15 developing sites and negotiating the commercial lease terms. However, ENO and its legal  
16 counsel will certainly be involved during the process. ENO will also have the final say on  
17 what terms have been negotiated by Brightergy and the acceptability of the overall  
18 agreement prior to execution.

19  
20 **VI. POTENTIAL BENEFITS**

21 Q38. PLEASE DESCRIBE THE POTENTIAL BENEFITS OF THE PROJECT.

22 A. There are multiple potential benefits of the Project for ENO and its four main  
23 stakeholders: customers (including the host sites), the local community, employees, and

1           shareholders. For ENO, the Project provides an opportunity to visibly support renewable  
2           energy in multiple locations around the City of New Orleans. The Project helps ENO  
3           progress toward meeting its commitment to add up to 100 MW of new renewable energy  
4           resources. Finally, the Project facilitates a new way for ENO to directly partner with its  
5           customers.

6                     For ENO’s customers, the Project provides a long-term hedge against the costs of  
7           conventional energy that is generally fossil fuel-fired. As a result, the Project will result  
8           in lower fuel costs that will be reflected in ENO’s fuel adjustment as well as generation  
9           capacity benefits. To be clear, the individual solar PV systems will be both too small to  
10          meet MISO’s 5 MW capacity resource threshold and will be interconnected at distribution  
11          voltage. Nonetheless, the individual solar PV systems comprising the Project will  
12          function as load modifying resources (“LMRs”) similar to the Paterson solar + battery  
13          project. The Project also provides the possible opportunity to site projects to maximize  
14          grid benefits and evaluate the potential for future investment deferrals in distribution  
15          infrastructure. Using rooftops also helps mitigate some of the cost challenges in Orleans  
16          Parish with ground-mounted solar PV systems. Examples of these include lack of suitable  
17          and affordable land, wetlands, soil conditions, and zoning requirements. Investing in DG-  
18          scale solar can provide an important component of a platform for future grid  
19          modernization efforts like energy storage (*e.g.*, batteries).

20                    For host sites, the Project allows them to “go solar” without direct investment or  
21          typical ownership/operational risks. The host site also receives the economic benefit from  
22          the long-term lease. By participating, host sites may also be able to impact their

1 Leadership in Energy and Environmental Design (“LEED”), sustainability accounting,  
2 and/or carbon reduction goals.

3 As far as the community, the Project entails increased local investment and use of  
4 local labor. With local investment comes the associated economic benefits to Orleans  
5 Parish including property taxes, sales tax on equipment, labor spend and associated  
6 multipliers. Using rooftops also means that land is not taken out of commerce for other,  
7 potentially more value-added economic development purposes.

8 For ENO’s employees, the Project provides a great opportunity to gain additional  
9 real-world experience with constructing and integrating DG-scale solar PV systems.  
10 Finally, the Project provides a new opportunity for shareholders to invest capital in the  
11 City of New Orleans.

12

13 **VII. SUNIVA TRADE COMPLAINT**

14 Q39. PLEASE PROVIDE A HIGH LEVEL DESCRIPTION OF THE SUNIVA COMPLAINT  
15 AND WHY IT COULD AFFECT THE PROJECT.

16 A. In April 2017, a Georgia-based solar panel company called Suniva filed for bankruptcy.  
17 Shortly afterwards, Suniva filed a trade complaint under Section 201 of the Trade Act of  
18 1974 with the U.S. International Trade Commission (“U.S. ITC”) alleging unfair trade  
19 practices by foreign manufacturers of solar cells and solar modules.<sup>3</sup> The initial  
20 complaint asks for duties on imported cells of \$0.40/Watt and a price floor on imported  
21 modules of \$0.78/Watt although I understand from very recent events that Suniva is

---

<sup>3</sup> U.S. International Trade Commission Investigation No. TA-201-75 into Crystalline Silicon Photovoltaic Cells as amended and properly filed on May 17, 2017.

1 asking for lower duties.<sup>4</sup> Unlike most trade complaints which are directed at individual  
2 nations, the Section 201 complaint and request for relief filed by Suniva would apply to  
3 imported cells and solar panels from all foreign countries and may materially affect the  
4 cost of imported solar panels. Attached as Exhibit DAO-5 is a summary of the case  
5 prepared by the U.S. ITC.

6 The complaint was accepted by the U.S. ITC M17, 2017. The U.S. ITC held a  
7 hearing on August 15 and voted 4-0 in an opinion issued September 22, 2017, that injury  
8 had occurred. While I am not an attorney, it is my understanding that the initial injury  
9 determination is likely to play a significant role in the U.S. ITC's finalizing its decision.  
10 Any decision to propose remedies to the White House must be made within 180 days of  
11 the complaint being effective (*i.e.*, November 13, 2017). The White House will then have  
12 up to 60 days (mid-January 2018) to accept, reject, or modify the U.S. ITC's proposed  
13 remedies. Based on what I have read about the case thus far, my understanding is that the  
14 Trump Administration has wide latitude to decide on a course of action and will make the  
15 ultimate decision, regardless of what the U.S. ITC determines and recommends in  
16 November.

17  
18 Q40. WHAT ARE THE POSSIBLE IMPLICATIONS OF THE CASE FOR THE PROJECT?

19 A. Right now, it is still too early to tell. However, if the U.S. ITC recommends, and the  
20 Trump Administration accepts or modifies, remedies that include tariffs and/or minimum

---

<sup>4</sup> ITC seeks more details as solar sector battles over remedies in trade case hearing; [www.utilitydive.com](http://www.utilitydive.com); Krysti Shallenberger, October 4, 2017.



1 price floor provisions on imported solar cells and panels, the cost of the Project could  
2 increase, perhaps by a significant amount.

3 Q41. ARE THERE ANY STEPS THAT ENO CAN TAKE RIGHT NOW TO INSULATE  
4 THE PROJECT AND MAINTAIN ITS CURRENT COSTS?

5 A. ENO has taken a proactive step to request that Brightergy set aside enough solar panels in  
6 its existing inventory to allow for the construction of the first solar PV system associated  
7 with the Project at ENO's Dwyer Road service location, which Mr. Cureington describes  
8 more thoroughly in his Direct Testimony. However, for the Project as a whole, ENO  
9 unfortunately does not have the ability to mitigate these risks since the other participating  
10 sites have not been conclusively identified, nor have systems been fully designed. ENO  
11 has discussed the matter with Brightergy, who indicated that any decision by the  
12 Administration to impose tariffs and/or other remedies may negatively impact solar panel  
13 prices relative to what is reflected in the executed EPC agreement. Until approval from  
14 the Council is received, Brightergy is not in a position to secure sufficient additional  
15 inventory of panels for solar PV systems that are scheduled to begin construction during  
16 2018. In the event that ENO is dealing with a situation where the Project can no longer be  
17 completed at the expected construction cost, depending on the timing of approval of this  
18 Application, ENO will seek the Council's guidance on what steps to take next. Those  
19 steps could include suspending the Project until more clarity is available on solar  
20 equipment availability and pricing. That would be an unfortunate and, frankly, very  
21 disappointing outcome after all the work that has gone into the Project. Aside from taking  
22 the initial step on the Dwyer Road site, there is little else that Brightergy and ENO are

1           able to do at this time given the timeline I described above and the significant uncertainty  
2           that the Suniva trade complaint has created for the solar industry as a whole.

3   Q42.   DOES THIS CONCLUDE YOUR DIRECT TESTIMONY?

4   A.     Yes, at this time.

**AFFIDAVIT**

**STATE OF LOUISIANA**

**PARISH OF ORLEANS**

**NOW BEFORE ME**, the undersigned authority, personally came and appeared,  
**David A. Owens**, who after being duly sworn by me, did depose and say:

That the above and foregoing is his sworn testimony in this proceeding and that he knows the contents thereof, that the same are true as stated, except as to matters and things, if any, stated on information and belief, and that as to those matters and things, he verily believes them to be true.



\_\_\_\_\_  
David A. Owens

**SWORN TO AND SUBSCRIBED BEFORE ME**  
**THIS 4<sup>th</sup> DAY OF OCTOBER, 2017**



\_\_\_\_\_  
NOTARY PUBLIC

My commission expires: at death

**Harry M. Barton**  
**Notary Public**  
**Notary ID# 90845**  
**Parish of Orleans, State of Louisiana**  
**My Commission is for Life**

<b>Docket</b>	<b>Description</b>
LPSC Docket No. U-30422 (Subdocket A)	Certification of Acquisition of Ouachita Unit 3
LPSC Docket No. U-31147	Petition for Approval of 2010-2012 EAI Wholesale Baseload (“WBL”) Power Purchase Agreement (“PPA”)
LPSC Docket No. U-31284	Petition for Approval of 2010 Exelon-Frontier Contract (PPA)
LPSC Docket No. U-31841	Petition for Approval of 2011-2014 Dow Contract (PPA)
LPSC Docket No. U-31174	Request for Approval of Federal Environmental Adjustment Clause (“EAC”) Catch-up for Jan-May 2009
LPSC Docket No. U-31196	Certification of Acquisition of Acadia Power Block Two
LPSC Docket No. U-30670	Waterford 3 Steam Generator Replacement
LPSC Docket No. U-32557	Petition for Approval of Rain 20-Year PPA
LPSC Docket No. U-32785	Petition for Approval of Agrilectric 20-Year PPA
LPSC Docket No. U-32759	Request for Approval of Cost Recovery for Calcasieu Long-Term Service Agreement (“LTSA”)
LPSC Docket No. U-32981	Petition for Approval of Montauk 10-Year PPA
LPSC Docket No. U-33244	Petition for Approval of EGSL-ELL Business Combination Application
CNO Docket No. UD-14-03	Petition for Approval of EGSL-ELL Business Combination Application
APSC Docket No. 16-027-R	Net Metering and the Implementation of Act 827 of 2015
APSC Docket No. 15-076-U	Petition by Forrest City for Approval of a Greater than 300 kW Net-Metered Solar Project
APSC Docket No. 16-089-U	Petition by Stratton Seed Company for Approval of a Greater than 300 kW Net-Metered Solar Project

**BEFORE THE  
COUNCIL OF THE CITY OF NEW ORLEANS**

**APPLICATION OF ENTERGY NEW )  
ORLEANS, INC. FOR APPROVAL TO )  
CONSTRUCT DISTRIBUTED GENERATION- )  
SCALE SOLAR PHOTOVOLTAIC SYSTEMS ) DOCKET NO. UD-17-\_\_  
AND REQUEST FOR COST RECOVERY AND )  
RELATED RELIEF )**

**EXHIBIT DAO-2**

**HIGHLY SENSITIVE  
PROTECTED MATERIAL  
INTENTIONALLY OMITTED**

**OCTOBER 2017**

**BEFORE THE  
COUNCIL OF THE CITY OF NEW ORLEANS**

**APPLICATION OF ENTERGY NEW )  
ORLEANS, INC. FOR APPROVAL TO )  
CONSTRUCT DISTRIBUTED GENERATION- )  
SCALE SOLAR PHOTOVOLTAIC SYSTEMS ) DOCKET NO. UD-17-\_\_  
AND REQUEST FOR COST RECOVERY AND )  
RELATED RELIEF )**

**EXHIBIT DAO-3**

**HIGHLY SENSITIVE  
PROTECTED MATERIAL  
INTENTIONALLY OMITTED**

**OCTOBER 2017**

**BEFORE THE  
COUNCIL OF THE CITY OF NEW ORLEANS**

**APPLICATION OF ENTERGY NEW )  
ORLEANS, INC. FOR APPROVAL TO )  
CONSTRUCT DISTRIBUTED GENERATION- )  
SCALE SOLAR PHOTOVOLTAIC SYSTEMS ) DOCKET NO. UD-17-\_\_  
AND REQUEST FOR COST RECOVERY AND )  
RELATED RELIEF )**

**EXHIBIT DAO-4**

**HIGHLY SENSITIVE  
PROTECTED MATERIAL  
INTENTIONALLY OMITTED**

**OCTOBER 2017**

**UNITED STATES INTERNATIONAL TRADE COMMISSION**  
**Washington, DC**

**Investigation No. TA-201-75**

**Crystalline Silicon Photovoltaic Cells**  
**(Whether or Not Partially or Fully Assembled into Other Products)**

Institution and Scheduling of Safeguard Investigation and Determination that the Investigation is Extraordinarily Complicated.

**AGENCY:** United States International Trade Commission.

**ACTION:** Notice of institution of investigation and scheduling of public hearings.

**SUMMARY:** Following receipt of a petition for import relief, as amended and properly filed on May 17, 2017, the Commission has instituted investigation No. TA-201-75 pursuant to section 202 of the Trade Act of 1974 (“the Act”) (19 U.S.C. § 2252) to determine whether crystalline silicon photovoltaic (“CSPV”) cells (whether or not partially or fully assembled into other products) are being imported into the United States in such increased quantities as to be a substantial cause of serious injury, or the threat thereof, to the domestic industry producing an article like or directly competitive with the imported articles. The Commission has deemed the petition, as amended, to have been properly filed on May 17, 2017. The Commission has determined that this investigation is “extraordinarily complicated” within the meaning of section 202(b)(2)(B) of the Act (19 U.S.C. § 2252(b)(2)(B)), and will make its injury determination within 128 days after the petition was filed, or by September 22, 2017. The Commission will submit to the President the report required under section 202(f) of the Act (19 U.S.C. § 2252(f)(1)) within 180 days after the date on which the petition was filed, or by November 13, 2017.

**EFFECTIVE DATE:** May 17, 2017.

**FOR FURTHER INFORMATION CONTACT:** Mary Messer (202-205-3193), Office of Investigations, U.S. International Trade Commission, 500 E Street SW, Washington, DC 20436.

Hearing-impaired persons can obtain information on this matter by contacting the Commission’s TDD terminal on 202-205-1810. Persons with mobility impairments who will need special assistance in gaining access to the Commission should contact the Office of the Secretary at 202-205-2000. General information concerning the Commission may also be obtained by accessing its internet server (<https://www.usitc.gov>). The public record for this investigation may be viewed on the Commission’s electronic docket (EDIS) at <https://edis.usitc.gov>.



**SUPPLEMENTARY INFORMATION:**

**Background.** – This investigation is being instituted, pursuant to section 202 of the Act (19 U.S.C. § 2252), in response to a petition, as amended and properly filed on May 17, 2017, by Suniva, Inc. (“Suniva”), a producer of CSPV cells and CSPV modules in the United States. Suniva seeks relief on CSPV cells (whether or not partially or fully assembled into other products).

The articles covered by this investigation are CSPV cells, whether or not partially or fully assembled into other products, including, but not limited to, modules, laminates, panels, and building-integrated materials. The investigation covers crystalline silicon photovoltaic cells of a thickness equal to or greater than 20 micrometers, having a p/n junction (or variant thereof) formed by any means, whether or not the cell has undergone other processing, including, but not limited to cleaning, etching, coating, and/or addition of materials (including, but not limited to, metallization and conductor patterns) to collect and forward the electricity that is generated by the cell.

Included in the scope of the investigation are photovoltaic cells that contain crystalline silicon in addition to other photovoltaic materials. This includes, but is not limited to, passivated emitter rear contact (“PERC”) cells, heterojunction with intrinsic thin-layer (“HIT”) cells, and other so-called “hybrid” cells.

Articles under consideration also may be described at the time of importation as components for final finished products that are assembled after importation, including, but not limited to, modules, laminates, panels, and building-integrated materials.

Excluded from the investigation are CSPV cells, whether or not partially or fully assembled into other products, if the CSPV cells were manufactured in the United States.

Also excluded from the investigation are thin film photovoltaic products produced from amorphous silicon (a-Si), cadmium telluride (CdTe), or copper indium gallium selenide (CIGS).

Also excluded from the scope of the investigation are crystalline silicon photovoltaic cells, not exceeding 10,000mm<sup>2</sup> in surface area, that are permanently integrated into a consumer good whose function is other than power generation and that consumes the electricity generated by the integrated crystalline silicon photovoltaic cell. Where more than one cell is permanently integrated into a consumer good, the surface area for purposes of this exclusion shall be the total combined surface area of all cells that are integrated into the consumer good.

For Customs purposes, the CSPV cells covered by the investigation are provided for under Harmonized Tariff Schedule of the United States (“HTSUS”) subheading 8541.40.60. Within that 8-digit subheading, CSPV cells that are assembled into modules or panels are

imported under HTSUS statistical reporting number 8541.40.6020, while CSPV cells that are not assembled into modules and are presented separately are imported under statistical reporting number 8541.40.6030. Inverters or batteries with CSPV cells attached can be imported under HTSUS subheadings 8501.61.00 and 8507.20.80, respectively. In addition, CSPV cells covered by the investigation may also be classifiable as DC generators of subheading 8501.31.80, when such generators are imported with CSPV cells attached. While HTSUS provisions are provided for convenience, the written description of the scope is dispositive.

For further information concerning the conduct of this investigation and rules of general application, consult the Commission's Rules of Practice and Procedure, part 201, subparts A and B (19 CFR part 201), and part 206, subparts A and B (19 CFR part 206).

**Determination to institute this investigation.** – Suniva initially submitted a petition on April 26, 2017. On May 1, 2017, Commission staff issued a letter requesting that Suniva clarify its description of the imported articles intended to be covered by the petition, provide more details concerning whether Suniva was “representative of an industry” within the meaning of section 202(a)(1) of the Act (19 U.S.C. § 2252(a)(1)), and supply additional data on the performance indicators for the industry producing an article like or directly competitive with the imported article. On May 12, 2017, Suniva provided additional information to support its allegations. On May 17, 2017, Suniva further amended its petition and provided a revised description of the imported articles. The Commission determined that the petition, as amended, was properly filed as of May 17, 2017.

**Determination that investigation is extraordinarily complicated.** – The Commission has determined that this investigation is “extraordinarily complicated” within the meaning of section 202(b)(2)(B) of the Act (19 U.S.C. § 2252(b)(2)(B)). The Commission's decision to designate this investigation “extraordinarily complicated” is based on the complexity of the issues, including the existence of antidumping and/or countervailing duty orders on certain imports covered by this investigation and the global supply chains for the imported articles under investigation. Ordinarily, the Commission would have been required to make its injury determination within 120 days after the petition was filed, or by September 14, 2017. The statute permits the Commission to take up to 30 additional days to make its injury determination in an investigation where it determines that the investigation is extraordinarily complicated. In this instance, the Commission intends to take eight extra days and make its injury determination by September 22, 2017.

**Participation in the investigation and public service list.** – Persons (other than petitioner) wishing to participate in the investigation as parties must file an entry of appearance with the Secretary to the Commission, as provided in section 201.11 of the Commission's rules, not later than 21 days after publication of this notice in the *Federal Register*. The Secretary will prepare a service list containing the names and addresses of all persons, or their representatives, who are parties to this investigation upon the expiration of the period for filing

entries of appearance.

**Limited disclosure of confidential business information (CBI) under an administrative protective order (APO) and CBI service list.** – Pursuant to section 206.17 of the Commission’s rules, the Secretary will make CBI gathered in this investigation available to authorized applicants representing interested parties (as defined in 19 C.F.R. § 206.17(a)(3)(iii)) under the APO issued in the investigation, provided that the application is made not later than 21 days after the publication of this notice in the *Federal Register*. A separate service list will be maintained by the Secretary for those parties authorized to receive CBI under the APO.

The Commission may include CBI in the reports it sends to the President and to the U.S. Trade Representative. Additionally, all information, including CBI, submitted in this investigation may be disclosed to and used by (i) the Commission, its employees and Offices, and contract personnel (a) for developing or maintaining the records of this or a related proceeding, or (b) in internal investigations, audits, reviews, and evaluations relating to the programs, personnel, and operations of the Commission including under 5 U.S.C. Appendix 3; or (ii) by U.S. government employees and contract personnel for cybersecurity purposes. The Commission will not otherwise disclose any CBI in a manner that would reveal the operations of the firm supplying the information.

**Hearings on injury and remedy.** – The Commission has scheduled separate hearings in connection with the injury and remedy phases of this investigation. The hearing on injury will be held beginning at 9:30 a.m. on August 15, 2017, at the U.S. International Trade Commission Building, 500 E Street SW, Washington, DC. In the event that the Commission makes an affirmative injury determination or is equally divided on the question of injury in this investigation, a hearing on the question of remedy will be held beginning at 9:30 a.m. on October 3, 2017. Requests to appear at the hearings should be filed in writing with the Secretary to the Commission on or before August 9, 2017 for the injury hearing, and September 27, 2017 for the remedy hearing. A nonparty who has testimony that may aid the Commission’s deliberations may request permission to present a short statement at the hearings. All parties and nonparties desiring to appear at the hearings and make oral presentations should participate in prehearing conferences to be held on August 11, 2017 for the injury hearing and September 28, 2017 for the remedy hearing, if deemed necessary. Oral testimony and written materials to be submitted at the public hearings are governed by sections 201.6(b)(2) 201.13(f), and 206.5 of the Commission’s rules. Parties must submit any request to present a portion of their hearing testimony **in camera** no later than 7 business days prior to the date of the respective hearings.

**Written submissions.** – Each party who is an interested party may submit a prehearing brief to the Commission. Prehearing briefs must conform with the provisions of sections 201.8, 206.7, and 206.8 of the Commission’s rules. The deadline for filing prehearing briefs on injury is August 8, 2017; that for filing prehearing briefs on remedy, including any commitments

pursuant to 19 U.S.C. § 2252(a)(6)(B), is September 27, 2017. Parties may also file written testimony in connection with their presentation at the hearing, as provided in sections 201.13, 206.5, and 206.8 of the Commission's rules, and posthearing briefs, which must conform with the provisions of sections 201.8, 201.13, 206.7, and 206.8 of Commission's rules. The deadline for filing posthearing briefs for the injury phase of the investigation is August 22, 2017; the deadline for filing posthearing briefs for the remedy phase of the investigation, if any, is October 10, 2017. In addition, any person who has not entered an appearance as a party to the investigation may submit a written statement of information pertinent to the consideration of injury on or before August 22, 2017, and pertinent to the consideration of remedy on or before October 10, 2017. All written submissions must conform with the provisions of section 201.8 of the Commission's rules; any submissions that contain CBI must also conform with the requirements of sections 201.6 and 206.17 of the Commission's rules. The Commission's *Handbook on E-Filing*, available on the Commission's website at [https://www.usitc.gov/secretary/documents/handbook\\_on\\_filing\\_procedures.pdf](https://www.usitc.gov/secretary/documents/handbook_on_filing_procedures.pdf), elaborates upon the Commission's rules with respect to electronic filing.

Any additional written submission to the Commission, including requests pursuant to section 201.12 of the Commission's rules, will not be accepted unless good cause is shown for accepting such a submission, or unless the submission is pursuant to a specific request by a Commissioner or Commission staff.

In accordance with section 201.16(c) of the Commission's rules, each document filed by a party to the investigation must be served on all other parties to the investigation (as identified by the service list), and a certificate of service must be timely filed. The Secretary will not accept a document for filing without a certificate of service.

**AUTHORITY:** This investigation is being conducted under authority of Section 202 of the Act; this notice is published pursuant to section 203(b)(3) of the Act.

By order of the Commission.



Lisa R. Barton  
Secretary to the Commission

Issued: May 23, 2017

**BEFORE THE  
COUNCIL OF THE CITY OF NEW ORLEANS**

**APPLICATION OF ENTERGY NEW )  
ORLEANS, INC. FOR APPROVAL TO )  
CONSTRUCT DISTRIBUTED )  
GENERATION-SCALE SOLAR )  
PHOTOVOLTAIC SYSTEMS AND )  
REQUEST FOR COST RECOVERY )  
AND RELATED RELIEF )**

**DOCKET NO. UD-17-\_\_**

**DIRECT TESTIMONY**

**OF**

**SETH E. CUREINGTON**

**ON BEHALF OF**

**ENTERGY NEW ORLEANS, INC.**

**OCTOBER 2017**

## Table of Contents

I.	INTRODUCTION .....	1
II.	ENO’s 2016 RENEWABLES RFP .....	4
III.	OVERALL EVALUATION AND RESOURCE SELECTIONS .....	8
IV.	THE COMPANY’S APPLICATION IS IN THE PUBLIC INTEREST .....	12

## EXHIBIT LIST

Exhibit SEC-1	List of prior testimony before the Council
Exhibit SEC-2	<i>Final Report of the Independent Monitor: Entergy Services, Inc. 2016 Request for Proposals For Long-Term Renewable Generation Resources for Entergy New Orleans, Inc.</i> , September 21, 2017, Prepared by Merrimack Energy Group, Inc. (Highly Sensitive Protected Material (“HSPM”))
Exhibit SEC-3	2016 Renewable RFP documents (CD-ROM)
Exhibit SEC-4	May 9, 2017 ENO Operating Committee presentation (HSPM)
Exhibit SEC-5	July 26, 2017 presentation by ENO to the Council (Update on ENO’s 2016 Renewables RFP)
Exhibit SEC-6	September 26, 2017 Operating Committee presentation (HSPM)

**I. INTRODUCTION**

1  
2  
3  
4  
5  
6  
7  
8  
9  
10  
11  
12  
13  
14  
15  
16  
17  
18  
19  
20  
21  
22

Q1. PLEASE STATE YOUR NAME AND CURRENT BUSINESS ADDRESS.

A. My name is Seth E. Cureington. My business address is 1600 Perdido Street, New Orleans, Louisiana 70112.

Q2. WHAT ARE YOUR CURRENT DUTIES?

A. I am employed by Entergy New Orleans, Inc., (“ENO” or the “Company”) as Director, Resource Planning and Market Operations. In that capacity, among other activities, I provide resource planning services to ENO.

Q3. ON WHOSE BEHALF ARE YOU TESTIFYING IN THIS PROCEEDING?

A. I am testifying in this proceeding before the Council of the City of New Orleans (“CNO” or the “Council”) on behalf of ENO.

Q4. WHAT ARE YOUR RESPONSIBILITIES AS DIRECTOR, RESOURCE PLANNING AND MARKET OPERATIONS?

A. As Director of ENO’s Resource Planning and Market Operations department, I am responsible for providing oversight to all of ENO’s integrated resource planning efforts, implementation plans, as well as market operations in the Midcontinent Independent System Operator, Inc. (“MISO”) regional transmission organization (“RTO”). I also serve as the Chairman of the ENO Operating Committee (the “OC”).

1 Q5. PLEASE DESCRIBE YOUR EDUCATIONAL BACKGROUND AND  
2 PROFESSIONAL EXPERIENCE.

3 A. I earned a Bachelor of Science degree in 2001 and a Master of Science in Economics in  
4 2004 from Louisiana State University.

5 I began my career with Entergy Services, Inc. (“ESI”) as a Senior Analyst with the  
6 System Planning and Operations (“SPO”) organization in 2006, where I was responsible  
7 for providing technical and analytical support for a wide range of commercial and supply  
8 procurement activities for the EOCs. I remained with SPO for the following six years,  
9 during which time I was promoted to the role of Senior Wholesale Executive with the  
10 Commercial Operations Group where I was responsible for leading the technical and  
11 commercial evaluation of all long-term generation supply opportunities in support of the  
12 EOCs’ portfolio transformation initiative. In 2011, I joined ENO’s Regulatory Affairs  
13 organization as Manager, Resource Planning where I was responsible for providing  
14 oversight to the development of ENO’s integrated resource plans and providing guidance  
15 and analytical support to ENO’s Regulatory Affairs group with respect to the integrated  
16 resource planning process. In 2013, my responsibilities were expanded to include  
17 oversight of market operations in MISO, and in June 2016, I was promoted to Director,  
18 Resource Planning and Market Operations.

19

20 Q6. HAVE YOU TESTIFIED PREVIOUSLY BEFORE THE CITY COUNCIL?

21 A. Yes. I have attached as Exhibit SEC-1 a listing of my prior testimony before the Council.

22



1 Q7. WHAT IS THE PURPOSE OF YOUR TESTIMONY?

2 A. I am testifying in support of the Company's Application, which seeks approval of its plan  
3 to construct distributed generation ("DG")-scale solar photovoltaic ("PV") systems (the  
4 "Project") within ENO's service area. In my Direct Testimony, I describe the 2016  
5 Renewables Request for Proposals ("RFP") that resulted in the Project being selected;<sup>1</sup> the  
6 basis for ENO's selection of the Project in May 2017; additional decisions ENO made in  
7 September 2017 concerning the Project and ENO's strategy for fulfilling its commitment  
8 to pursue the addition of up to 100 MW of renewable resources to its portfolio; and the  
9 basis for a Council decision that the Company's Application is in the public interest and,  
10 therefore, prudent.

11

12 Q8. IS ENO SUBMITTING OTHER DIRECT TESTIMONY IN SUPPORT OF ITS  
13 APPLICATION?

14 A. Yes. In addition to my Direct Testimony, the Company is submitting the Direct  
15 Testimony of Mr. D. Andrew Owens, who will discuss the various details and potential  
16 benefits of the Project, and the Direct Testimony of Mr. Orlando Todd who will discuss  
17 the costs associated with the Project as well as the proposed cost recovery.

18

---

<sup>1</sup> In addition to the Project, two other solar proposals totaling 40 MW were selected in May 2017.

1 **II. ENO's 2016 RENEWABLES RFP**

2 Q9. PLEASE DESCRIBE THE 2016 RENEWABLES RFP.

3 A. On March 22, 2016, ESI published a public notice that ENO intended to issue a  
4 renewables-specific RFP. The notice provided the expected near-term milestones, a high-  
5 level description of why ENO chose to undertake the RFP, the parameters around the  
6 types and sizing of renewable resources that the RFP intended to solicit, ENO's intention  
7 to submit a 5 MW "self-build" project into the RFP, and the engagement of Mr. Wayne  
8 Oliver of Merrimack Energy Group Inc. to serve as the Independent Monitor ("IM").<sup>2</sup> To  
9 support the 2016 Renewables RFP, ESI also set up a public website on [www.energy.com](http://www.energy.com)  
10 where all notices were made, draft and final RFP documents were accessible, and  
11 prospective bidders could submit comments and questions.

12 On May 6, 2016, ESI provided notice to prospective bidders and other interested  
13 parties that the website had been updated with the various draft RFP documents and that a  
14 public bidder's conference would be held at ENO's offices on June 1, 2016. The notice of  
15 the public bidder's conference also provided dial-in information for interested participants  
16 who could not attend in person. ENO held the public bidder's conference as scheduled on  
17 June 1, 2016, and 22 attendees, representing a range of interested parties, participated. At  
18 the conference, ESI and ENO staff, including myself, presented information about ENO's  
19 2016 Renewables RFP and addressed any questions or concerns raised by prospective  
20 bidders. Additionally, the RFP website also provided a specific email address for the  
21 submission of questions and comments.

---

<sup>2</sup> I have attached the IM's Final Report hereto as Highly Sensitive Protected Material ("HSPM") Exhibit SEC-2.

1           ENO and ESI issued the final RFP documents on July 13, 2016. Also, all  
2           questions and responses were provided on the website and were updated regularly until  
3           the proposals were due in early October 2016. The RFP website also provided redline  
4           copies of all bid documents so that bidders could see any changes that had been made  
5           relative to the draft RFP documents that were issued in May 2016. I have provided the  
6           final 2016 Renewables RFP documents on a CD-ROM as Exhibit SEC-3. As far as the  
7           remaining schedule of the RFP, ENO's self-build proposal was due the week of  
8           September 26-30, 2016, with other bids due the week of October 3-7, 2016.

9  
10 Q10. WHAT WERE THE OBJECTIVES OF THE 2016 RENEWABLES RFP?

11 A. Several contributing factors motivated ENO's management to pursue a renewable-specific  
12 RFP in early 2016. First, feedback from Stakeholders and the Council's Advisors  
13 provided during the 2015 Integrated Resource Plan ("IRP") process led ENO to develop  
14 an Action Plan for ENO.<sup>3</sup> As part of the IRP Action Plan, ENO made the commitment to  
15 conduct a renewables RFP in order to obtain better information on the cost and  
16 deliverability of renewable resources in ENO's footprint and the surrounding area.

17           Second, during the time ENO considered developing the RFP, ENO was in the  
18 process of constructing a ~1 MW ground-mounted solar and advanced Li-ion battery  
19 storage project at the A.B. Paterson site in eastern New Orleans. Implementing a  
20 renewables-specific RFP would allow ENO to build upon that experience of owning and  
21 operating renewable resources.

---

<sup>3</sup> See Docket No. UD-08-02, ENO Final 2015 Integrated Resource Plan Report dated February 1, 2016, pp. 76-77.

1           Finally, and perhaps most importantly, ENO wanted to see if renewable resources  
2           were available that could provide cost-effective supply, fuel diversity benefits, and other  
3           potential benefits to ENO's customers. In order to facilitate the RFP process and meet  
4           these multiple objectives, ENO limited qualifying renewable technologies to existing or  
5           new resources that would use commercially-proven run-of-river hydroelectric, solar PV,  
6           or onshore wind. The RFP also sought to further these objectives by stating a preference  
7           for resources within the ENO region. Among other things, this preference was stated to  
8           provide ENO with specific insight into the costs and feasibility of deploying renewable  
9           resources in and around Orleans Parish and the benefits of locating generation in close  
10          proximity to the load they serve.

11  
12   Q11.   WHAT WAS YOUR ROLE IN THE 2016 RENEWABLES RFP?

13   A.     I was involved on the front-end of the process with respect to designing the RFP and  
14          ensuring that ENO's objectives would be met. Through my role on the OC, I supported  
15          the Company's decision in February 2016 to develop and submit a self-build proposal into  
16          the RFP process that ultimately resulted in this Application for the Project although, to be  
17          clear, I had no role in actually preparing the self-build proposal that was submitted on  
18          September 30, 2016. During the period between when bids were submitted and the final  
19          selections were made by ENO in May 2017, my involvement in the RFP was generally  
20          limited to periodic status updates.

1 Q12. WHAT PROCESS SAFEGUARDS WERE ESTABLISHED TO ENSURE THAT THE  
2 RFP WAS CONDUCTED IN AN OBJECTIVE AND IMPARTIAL MANNER?

3 A. ESI established a number of process safeguards and procedures to ensure that information  
4 provided by bidders in response to the 2016 Renewables RFP was kept confidential and  
5 not improperly disclosed to, or used by, an employee, consultant, or other ESI  
6 representative or any other Entergy competitive affiliate. Each of these procedures is  
7 summarized<sup>4</sup> below:

- 8 • ESI retained an IM (Mr. Wayne Oliver of Merrimack Energy Group Inc.) to  
9 oversee the design and implementation of the RFP processes to (i) ensure that the  
10 processes were fair and objective, and (ii) to help ensure that all proposals were  
11 treated in a consistent fashion and without undue preference given to any bidder.
- 12 • All employees of ESI or any Operating Company were required to adhere to the  
13 Entergy Affiliate Rules and Codes of Conduct, which, among other things,  
14 prohibit actions that provide an unfair competitive advantage or preferential  
15 treatment to competitive affiliates, and prohibits the inappropriate transfer of  
16 confidential information to competitive affiliates.
- 17 • Each person participating in the evaluation of proposals was required to adhere to  
18 an Evaluation Confidentiality Acknowledgement, which limits and restricts the use  
19 of information.
- 20 • ESI utilized an RFP Administrator to perform several duties, which included  
21 acting as an intermediary between ESI and bidders to address questions and issues  
22 and to ensure that each evaluation team had the relevant information needed to  
23 perform its respective analyses and that all information was evaluated on a  
24 collaborative basis.
- 25 • ESI also established an RFP Administrative Team to assist the RFP Administrator.  
26 The RFP Administrative Team acted to ensure that each evaluation team had the  
27 information needed to perform its analyses in a manner that was fair and impartial  
28 and that would result in the selection of the most viable and economic renewable  
29 resources consistent with the overall objectives of the RFP.

---

<sup>4</sup> More specific details concerning these measures are provided in various sections of the main body of the 2016 Renewables RFP, as well as in Appendix G (Process for Protection of Proposal Information).

- 1           • As described in detail in Appendix G of the 2016 Renewables RFP, a detailed  
2           process was developed for submitting, reviewing, segregating, and evaluating  
3           proposals in order to ensure the objective and impartial treatment of all bidders and  
4           to appropriately preserve the confidentiality of certain information provided by  
5           bidders under the RFP.
  
- 6           • To maintain impartiality and confidentiality, five (5) separate evaluation teams  
7           were created to review specific, distinct aspects of each proposal.
  
- 8           • During the proposal evaluation phase, information was segregated into  
9           confidential reports, which were then made available to the appropriate evaluation  
10          teams. The different evaluation teams were permitted to see only those reports  
11          that included information necessary to carry out their respective parts of the  
12          proposal evaluation process.

13           Ultimately, the IM’s Final Report concluded, among other things, that the “2016 ENO  
14           Renewable Resource RFP solicitation process was undertaken in a fair, equitable, and  
15           unbiased manner by ESI with the oversight of the IM. The solicitation process initiated by  
16           ESI is a consistent and equitable process designed to treat all proposals the same  
17           throughout the process. The IM found that ESI followed its protocols and objectives  
18           throughout the solicitation.”<sup>5</sup>

### 20           **III. OVERALL EVALUATION AND RESOURCE SELECTIONS**

21   Q13. WAS THERE ROBUST PARTICIPATION IN THE 2016 RENEWABLES RFP?

22   A.   Yes, to the extent that ENO received 17 proposals representing approximately 325 MW of  
23          total capacity. The conforming bids ENO received were all for proposed solar PV  
24          resources. With respect to resource diversity among the solar PV bids, only one proposal  
25          – ENO’s 5 MW self-build project – involved DG-scale solar PV systems.

---

26           <sup>5</sup> See HSPM SEC-2 at pg. 36

1 Q14. WHAT PROPOSALS WERE SELECTED BY ENO?

2 A. I have attached as HSPM Exhibit SEC-4 a presentation made to the OC on May 9, 2017.  
3 At that time, ENO selected a portfolio of three (3) proposed resources from the pool of  
4 conforming proposals submitted into the RFP. Those three resources are the Project, a  
5 proposed 20 MW ground-mounted facility to be located in Orleans Parish that ENO would  
6 acquire upon completion (the “Build-Transfer project”), and a proposed 20 MW ground-  
7 mounted facility to be located outside of Orleans Parish where ENO would purchase the  
8 energy produced under a 20-year power purchase agreement (“PPA”). As described in a  
9 presentation made to the Council on July 26, 2017, which I have included as Exhibit SEC-  
10 5, successful negotiations with counter-parties for the PPA and the Build-Transfer project  
11 must be completed for those selections from the RFP to come to fruition.

12  
13 Q15. WHY WAS THE PROJECT SELECTED BY ENO?

14 A. In selecting the three solar PV proposals that I just described, ENO had to balance a  
15 number of objectives. As discussed above, the stated objectives of the RFP were to  
16 evaluate and potentially procure renewable resources that could provide cost-effective  
17 supply, fuel diversity benefits, and other potential benefits to ENO’s customers. Together,  
18 the three projects in the selected portfolio are projected to result in a net benefit to ENO’s  
19 customers of \$15/kW-yr, assuming the final terms and pricing ultimately negotiated for  
20 the projects conform to the bids submitted in the RFP. On a pure cost comparison basis  
21 based on the pricing submitted into the RFP, the Project is more expensive than the other  
22 two solar PV proposals that were selected. However, comparing the three selected

1 resource proposals purely on a \$/kW-yr basis does not provide an “apples to apples”  
2 comparison of the projects, nor does it take into account the various benefits of the  
3 Project, outlined below. With regard to cost comparison, the Council should note that  
4 aggregated DG-scale solar PV systems built at multiple customer-owned rooftop locations  
5 within a congested, urban area will naturally cost more on a \$/Watt basis than a utility-  
6 scale, ground-mounted solar PV facility built in a rural area where costs for items such as  
7 land, permitting, and property taxes are lower. As ENO learned when constructing its  
8 solar + battery project in early 2016, installing ground-mounted solar PV systems in the  
9 City of New Orleans does have challenges in terms of addressing soil conditions and  
10 meeting zoning requirements (*e.g.*, property fencing, mitigating storm water run-off).

11 While a remotely-located, rurally-sited, large-scale, ground-mounted solar PV  
12 project may appear, in the abstract, to be the lowest cost solar PV option available, there  
13 are other important benefits to consider in connection with locally-sited, rooftop solar PV  
14 systems such as risk mitigation, the benefits of local investment, and the value of locating  
15 resources closer to load. Ownership of a generating asset can help mitigate risk because it  
16 will be available for its full life to serve customers. A counter-party to a long-term PPA,  
17 however, may encounter future financial difficulties that create added risk around  
18 maintaining the asset and its deliverability. In addition, there are no guarantees that the  
19 resource will be available to re-contract for the portion of the asset’s expected life beyond  
20 the initial 20-year PPA term.

21 There are other potential benefits of the Project that are difficult to quantify and  
22 factor into an evaluation framework that is otherwise focused on the pure economics of



1 the proposals. Mr. Owens provides a more in-depth discussion in his Direct Testimony,  
2 but important benefits include the following:

- 3 • helps ENO achieve its commitment to add 100 MW of renewable resources;
- 4 • allows ENO to gain additional real-world experience with operating and  
5 maintaining DG-scale solar PV systems;
- 6 • potential opportunities to achieve distribution grid benefits;
- 7 • systems can facilitate future energy storage (*e.g.*, battery) investments;
- 8 • economic development benefits to Orleans Parish through increased local  
9 investment and use of local labor; and
- 10 • allows ENO to work directly with its customers to help achieve their goals around  
11 sustainability accounting and/or carbon reduction.

12 For all these reasons, ENO decided to select the portfolio of three proposed solar PV  
13 resources that included the Project. The Council should also note that the IM's Final  
14 Report concluded ENO's selections were reasonable.<sup>6</sup>

15  
16 Q16. YOU MENTIONED THAT SUCCESSFUL NEGOTIATIONS WITH COUNTER-  
17 PARTIES WILL BE REQUIRED TO BRING THE PPA AND THE BUILD-TRANSFER  
18 PROJECT TO FRUITION. HAS ENO CONTEMPLATED A STRATEGY FOR  
19 CONTINUING TO PURSUE A PORTFOLIO APPROACH FOR ADDING  
20 RENEWABLE GENERATION RESOURCES IF THESE SELECTIONS FROM THE  
21 RENEWABLES RFP DO NOT COME TO FRUITION?

22 A. Yes. First, I should note that due to the confidential nature of these negotiations, neither I  
23 nor any other representative of ENO can comment publicly on the specific status thereof.

---

<sup>6</sup> See HSPM SEC-2 at pg. 36

1           However, I have attached HSPM Exhibit SEC-6, which is a presentation from a  
2           September 2017 meeting of the OC and, among other things, outlines such a strategy.

3

4   Q17.   WOULD ENO STILL RECOMMEND PURSUING THE PROJECT EVEN IF  
5           NEGOTIATIONS WITH THE BIDDERS FOR THE GROUND-MOUNTED SOLAR  
6           PROJECTS FAIL TO PRODUCE AGREEMENTS, AND THE STRATEGY  
7           OUTLINED IN HSPM EXHIBIT SEC-6 DOES NOT YIELD RESULTS?

8   A.    Yes.  At a September 2017 meeting of the OC, ENO decided to continue pursuit of the  
9           Project, independent of the PPA and the Build-Transfer Project, due to the Project's  
10          potential benefits to stakeholders, which I outlined above and which Mr. Owens describes  
11          more thoroughly in his Direct Testimony.

12

13           **IV.   THE COMPANY'S APPLICATION IS IN THE PUBLIC INTEREST**

14   Q18.   WHAT IS THE COMPANY ASKING THE COUNCIL TO APPROVE WITH REGARD  
15          TO THE PROJECT?

16   A.    In its Application, ENO is asking the Council, subject to the fullest extent of its  
17          jurisdiction, to grant relief and give the Council's approval as follows: (i) find that the  
18          Project serves the public convenience and necessity and is in the public interest, and  
19          therefore is prudent; (ii) confirm that the Company's investments made pursuant to a  
20          public interest determination by the Council are presumed prudent and eligible for  
21          recovery from customers, and that the Company will have a full and fair opportunity to  
22          recover all prudently-incurred costs of the Project; (iii) authorize the requested cost

1 recovery treatment for the Project that Mr. Todd describes in his Direct Testimony; (iv)  
2 grant a waiver of any applicable requirement to the extent that such a waiver may be  
3 required to facilitate approval of the transaction described in this Application; and (v)  
4 order such other general and equitable relief as to which the Company may show itself  
5 entitled.

6  
7 Q19. BEFORE YOU EXPLAIN WHY THE PROJECT IS IN THE PUBLIC INTEREST,  
8 WOULD YOU FIRST DESCRIBE THE TERM “PUBLIC INTEREST” AS YOU  
9 UNDERSTAND IT?

10 A. Yes. The public interest has been sometimes described as that which is thought to best  
11 serve everyone; it serves the common good. If the net effect of a decision is believed to  
12 be positive or beneficial on the whole, it can be said that the decision serves the “public  
13 interest.”

14 Determining whether a decision is “in the public interest” requires a balancing of  
15 the various effects of a particular course of action measured subjectively over the longer  
16 run. Whether a course of action is “in the public interest” will depend upon factors that  
17 are potentially quantifiable on an estimated basis, such as likely changes in the rates  
18 ENO’s customers pay, as well as upon other factors that are not quantifiable, such as  
19 innovation in the provision of electric service. Finally, while witnesses can provide facts  
20 and opinions that bear on this issue, it is only the decision-maker, the Council in this  
21 instance, who can reach a conclusion as to whether the Project is in the public interest.

22

1 Q20. IN YOUR OPINION, IS THE PROJECT IN THE PUBLIC INTEREST?

2 A. Yes.

3

4 Q21. WHAT IS THE BASIS FOR THAT OPINION?

5 A. In the discussion above of why ENO selected the Project, I outline a number of important  
6 potential benefits. To re-cap, those potential benefits include: (i) allowing ENO to gain  
7 additional real-world experience with operating and maintaining DG-scale solar PV  
8 systems; (ii) achieving distribution grid benefits; (iii) facilitating opportunities for future  
9 energy storage (*e.g.*, battery) investments; (iv) providing economic development benefits  
10 to Orleans Parish through increased local investment and use of local labor; and (v)  
11 allowing ENO to work directly with its customers to help achieve their goals around  
12 sustainability accounting and/or carbon reduction. While I acknowledge that the Project is  
13 not the lowest cost solar PV alternative identified through the RFP, as I noted above,  
14 comparing the various bids to the Project on a pure \$/kW-yr basis does not provide an  
15 “apples to apples” comparison because none of the other proposals received involved DG-  
16 scale solar PV systems. ENO attempted to balance a number of different objectives in  
17 selecting each component of a portfolio of three solar PV proposals and I do believe the  
18 Project can provide important long-term benefits to ENO’s customers. I would add that  
19 rather than pursue Council approval of the Project absent any kind of competitive  
20 evaluation, ENO did conduct a formal RFP process using an IM, ENO received multiple  
21 proposals, and the IM’s Final Report concluded that “ESI treated the self-build option  
22 fairly and consistently relative to all other proposals,” and that “the ENO solicitation

1 process contain[ed] a number of safe-guards designed to ensure that all proposals were  
2 treated fairly and that there was no inherent advantage possible for the self-build option.”<sup>7</sup>

3 As noted above, the Project was the only proposal for deployment of DG-scale solar PV  
4 systems. The Project is also one of only two proposals (the other being the Build-Transfer  
5 project) that would site renewable resources in Orleans Parish.

6  
7 Q22. ARE THERE ANY OTHER FACTORS THAT THE COUNCIL SHOULD CONSIDER  
8 IN CONNECTION WITH THE PUBLIC INTEREST?

9 A. Yes. As Mr. Owens explains in his Direct Testimony, the Company worked with  
10 Brightergy Louisiana, LLC (“Brightergy”) in 2016 as part of formulating its proposal to  
11 screen customer-owned sites in New Orleans for suitability and rooftop solar PV potential.  
12 Based on those screening analyses, there appears to be significant potential to expand the  
13 Project in the future beyond the initial 5 MW of aggregated capacity. Once the Company  
14 has proven that the concept works and that Company-owned solar PV systems located on  
15 customer-owned sites represents an attractive supply option, ENO will have the ability to  
16 pursue an expansion of the Project in the future. As Mr. Owens explains, the focus thus  
17 far has been on the largest commercial rooftops (in the 20,000 – 100,000+ square foot  
18 range) where installation is easier and economies of scale can be gained. The focus for  
19 now excludes smaller commercial and governmental buildings that might be attractive for  
20 other public policy reasons. For example, non-profit organizations or religious institutions  
21 that consider installing rooftop solar PV systems themselves typically face challenging

---

<sup>7</sup> See HSPM SEC-2 at pgs. 36-37.

1 economics because (1) they are tax-exempt and, thus, are unable to lower their costs via  
2 certain tax advantages and (2) the design of most commercial rates that incorporate  
3 demand charges impact the cost-effectiveness of solar PV systems. By participating in the  
4 Project, such institutions may be able to achieve some of their sustainability objectives  
5 and also receive an on-going lease payment for hosting the solar PV system. Further, as  
6 Mr. Owens explains, one of the factors that the Company considered when it selected  
7 Brightergy in mid-2016 to assist with the Project was their strong experience working  
8 with K-12 schools and universities. More specifically, Brightergy has developed and  
9 implemented various educational materials and lesson plans for schools that install solar  
10 PV systems to use with their students. While the Project's initial focus is on large  
11 commercial sites like warehouses and distribution centers, ENO has met and discussed the  
12 Project with other local entities and will explore ways to cost-effectively expand the scope  
13 and scale in the future. The scope of such future expansion could be based on a level of  
14 customer interest in locating PV systems at their property, rather than a specific budgetary  
15 cap or limit.

16 Another factor that the Council should consider is the rapidly changing dynamics  
17 within the electric utility industry. Today, there are more than 1.4 million DG-scale solar  
18 PV systems in the U.S., most of which have been installed over the past 5-6 years.<sup>8</sup> In  
19 New Orleans, there are currently more than 7,100 rooftop solar PV systems directly  
20 interconnected to the distribution grid, which reflects ~3.5% of ENO's approximately

---

<sup>8</sup> U.S. Department of Energy, Energy Information Administration ("EIA") 826 data.

1 198,000 customers installing solar PV systems.<sup>9</sup> Although installation growth has slowed  
2 recently, New Orleans continues to see new solar PV systems installed each month.  
3 However, the vast majority of the systems (roughly 98%) have a capacity of < 10 kW<sub>DC</sub>  
4 and are installed on residential rooftops. There remains a large supply of commercial and  
5 governmental properties with larger roofs where increased economies of scale can be  
6 gained. A future expansion of the Project to utilize this supply of large rooftops would  
7 allow for more locally-sited PV generation, while avoiding the land use issues and  
8 complications that I describe above and which Mr. Owens also describes in his Direct  
9 Testimony.

10 Finally, Mr. Owens addresses in his Direct Testimony a situation that has recently  
11 arisen involving a trade complaint that was filed in May 2017 with the United States  
12 International Trade Commission (“U.S. ITC”) seeking new tariffs on solar cells and  
13 panels imported to the U.S. It is too early to tell what impact, if any, the trade complaint  
14 may have on the Project, but it is important for the Council to be aware of the situation.  
15 As Mr. Owens notes, if and when the White House issues a final decision on the case,  
16 ENO will inform the Council as to the possible impacts on the Project and its costs.

17  
18 Q23. HAS THE COMPANY TAKEN ANY ACTION TO ATTEMPT TO MITIGATE THE  
19 RISKS PRESENTED BY THE DEVELOPMENTS AT THE U.S. ITC THAT MR.  
20 OWENS DESCRIBES?

---

<sup>9</sup> *Ibid.*

1 A. Yes. Part of the Project involves constructing a Demonstration Site at the Company's  
2 service location on Dwyer Road in New Orleans East. There are a number of benefits of  
3 constructing the Demonstration Site, particularly for the early stages of the Project's  
4 development, such as (i) providing experience to the Project team on the interconnection  
5 process and the City permitting requirements and processes, (ii) allowing Brightergy to  
6 establish working relationships with local subcontractors, and (iii) providing a functioning  
7 site for other prospective host site owners to visit, which would help to allay concerns  
8 these hosts may have concerning the effects of PV installations on the appearance and  
9 structural integrity of their roofs. However, due to the time likely required for a thorough  
10 review of the Project through a complete regulatory proceeding before the Council, and  
11 the timing of expected action in the U.S. ITC case, it would not have been possible for  
12 ENO to receive Council approval of the Project in time to protect the Demonstration Site  
13 construction from price risk resulting from the pending U.S. ITC case. But given the  
14 importance of the Demonstration Site to the Project's viability and success, ENO decided,  
15 in conjunction with the September OC meeting discussed above, to give Brightergy  
16 approval to perform development and design work for the Site. Receiving ENO's  
17 approval within this timeframe allowed Brightergy to dedicate existing solar panels in  
18 their inventory to the construction of the Demonstration Site, thereby mitigating U.S. ITC-  
19 related price-risk associated with this specific aspect of the Project.

20

21 Q24. DOES THIS CONCLUDE YOUR DIRECT TESTIMONY?

22 A. Yes, at this time.



**AFFIDAVIT**

**STATE OF LOUISIANA**

**PARISH OF ORLEANS**

**NOW BEFORE ME**, the undersigned authority, personally came and appeared,  
**Seth E. Cureington**, who after being duly sworn by me, did depose and say:

That the above and foregoing is his sworn testimony in this proceeding and that he knows the contents thereof, that the same are true as stated, except as to matters and things, if any, stated on information and belief, and that as to those matters and things, he verily believes them to be true.



---

Seth E. Cureington

**SWORN TO AND SUBSCRIBED BEFORE ME**  
**THIS 4<sup>th</sup> DAY OF OCTOBER, 2017**

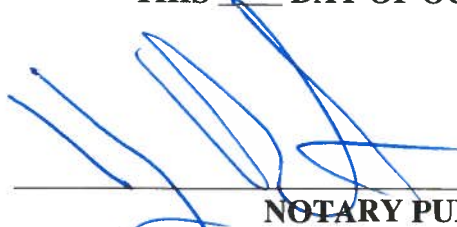

---

**NOTARY PUBLIC**

My commission expires: at death

Harry M. Barton  
Notary Public  
Notary ID# 90845  
Parish of Orleans, State of Louisiana  
My Commission is for Life

**Listing of Previous Testimony Filed by Seth E. Cureington**

<b><u>DATE</u></b>	<b><u>TYPE</u></b>	<b><u>SUBJECT MATTER</u></b>	<b><u>REGULATORY BODY</u></b>	<b><u>DOCKET NO.</u></b>
10/30/2014	Direct	Algiers Assesst Transfer	CNO	UD-14-02
02/09/2015	Direct	Union Power Station PPA	CNO	UD-15-01
08/21/2015	Supplemental	Union Power Station PPA	CNO	UD-15-01
06/20/2016	Direct	New Orleans Power Station	CNO	UD-16-02
11/18/2016	Supplemental	New Orleans Power Station	CNO	UD-16-02
07/06/2017	Supplemental	New Orleans Power Station	CNO	UD-16-02

***Final Report of the Independent Monitor***

***Entergy Services, Inc.***

***2016 Request for Proposals***

***For***

***Long-Term Renewable Generation Resources for Entergy***

***New Orleans, Inc.***

***September 21, 2017***

***Prepared by  
Merrimack Energy Group, Inc.***



# Table of Contents

Executive Summary ..... 2

I. Introduction ..... 4

II. Role and Activities of the Independent Monitor During the Bidding Process.... 6

III. Description of the ENO Solicitation Process ..... 7

IV. Conclusions ..... 36

## Executive Summary

Entergy New Orleans, Inc. (“ENO”) selected three projects as a result of its 2016 Request for Proposals for Long-Term Renewable Generation Resources (“RFP” or “2016 Renewable Resources RFP”), totaling 44.7 MW. Two of the projects were classified as acquisition options, whereby ENO would own the projects. Both projects are located in Orleans Parish and would serve the local in-region area of ENO’s system. The third project is a Power Purchase Agreement for a 20 MW solar PV project for a term of 20 years. The project is located in Duson, Louisiana.

Entergy Services, Inc. (“Entergy Services” or “ESI”)<sup>1</sup> issued the 2016 Renewable Resources RFP for ENO on July 13, 2016. The RFP sought up to 20 MW of energy, environmental attributes, capacity, capacity-related benefits and other electric products from eligible renewable resources for deliveries starting as early as June 1, 2018 and as late as June 1, 2020, on the terms set forth in the RFP to help ENO meet its integrated resource planning objectives, including increased depth and diversity of its generation resource portfolio. ESI also stated in the RFP that it intended to market test a self-build alternative as part of the RFP. Under the provisions of the RFP, physical deliveries of power under a Definitive Agreement entered into pursuant to this RFP must be to MISO (e.g. resources directly interconnected to the MISO System) or the “MISO South” portion of the MISO System (LRZ 8, 9, and 10 collectively). Purchases from resources interconnected at a transmission voltage level must be financially settled at the ENOI Load Node. ENO noted in the RFP that it prefers in order of preference, resources located in the ENO Load Zone, then in LRZ 9, then in MISO South, then MISO, and then outside of MISO.

Products solicited included Power Purchase Agreements (“PPA”) for all RFP-eligible technologies and acquisitions (Solar PV only). The generation technologies permitted for proposals offered into this RFP were commercially proven run-of-river hydro technology, Solar PV technology, and onshore wind technology.

Merrimack Energy Group, Inc. (“Merrimack Energy”) was selected to serve as the Independent Monitor (“IM”) by Entergy Services, Inc. for the 2016 Renewable Resources RFP.

Merrimack Energy’s involvement as IM began at the beginning of the draft RFP development process and continued through final evaluation and selection of the preferred proposal(s). The overriding responsibility of the IM was to ensure the competitive bidding process was undertaken in a fair and unbiased manner. The IM’s role was to (a) monitor the design and implementation of the RFP solicitation, evaluation, selection, and contract negotiation processes to ensure their impartiality and objectivity and (b) provide an objective, third-party perspective on ESI’s efforts to ensure that all proposals were treated consistently and without undue preference to any Bidder. A Scope of Work for the IM was prepared and included on the ENO Renewables RFP website

---

<sup>1</sup> ESI acts as agent for Entergy New Orleans, Inc. (“ENO”)

established for this solicitation. The major responsibilities and activities of the IM included oversight, review, monitoring, and reporting and cover several different phases of the RFP, including:

- The overall design of the RFP;
- The proposal solicitation process (RFP issuance, bidder registration, and proposal submission);
- The proposal evaluation process (including method of evaluation);
- The proposal selection process;
- The due diligence and negotiation process; and
- Regulatory review, as needed and requested

The IM had access to any employee of ESI or ENO, any data, process or analytical tool created or used in connection with the RFP, and any other information reasonably available to ESI or ENO related to the RFP to the extent the IM deemed such access necessary for ensuring that the RFP design, processes, and reviews were developed or conducted in a fair and impartial manner and subject to appropriate confidentiality safeguards to protect the integrity of the process. The IM also had the ability to communicate directly with the New Orleans City Council members that were participating in overseeing the RFP process, subject to appropriate Confidentiality safeguards.

ESI began the development of the RFP in the first quarter of 2016 and submitted a Notice of Intent to Issue a Request for Proposals letter to interested parties on March 22, 2016 indicating its intent to issue an RFP for Renewable Resources. The Notice indicated that Entergy planned to hold a Bidders Conference as early as June, 2016, with proposals due as early as October, 2016. Entergy issued the Final RFP on July 13, 2016 and bids were received by October 6, 2016. A total of seventeen proposals were received from ten Bidders totaling 324.7 MW, which was 16 times the amount requested.

The process was designed to evaluate bids through a consistent, defined two-phase process, culminating in the selection of bids for contract negotiation. The process resulted in the selection of three projects, including the ESI self-build option, as described in the first paragraph.

## **Conclusions**

Based on the review and evaluation undertaken by the IM, the IM concluded that the selection of the 20 MW Power Purchase Agreement with ██████████ was the highest valued option in terms of economic evaluation results (i.e. Net Benefits) and was classified as a low risk and viable project from a project viability risk assessment perspective. The selection of the self-build option ██████████ and an acquisition for a 20 MW project from ██████████, while not among the lowest cost proposals (in terms of net benefits), served to meet in-region requirements since these projects would be located in the ENO Load Zone. These two proposals were the only resources located in the ENO Load Zone that were submitted into the RFP.

## I. Introduction

### A. Background

Entergy Services, Inc. (“Entergy Services” or “ESI”)<sup>2</sup> issued its 2016 Request for Proposals For Long-Term Renewable Generation Resources (“2016 Renewable Resource RFP” or “RFP”) For Entergy New Orleans, Inc. (“ENO”) on July 13, 2016. The RFP sought up to 20 MW of Energy, Environmental Attributes, Capacity, Capacity-related Benefits and Other Electric Products from eligible renewable resources for deliveries starting as early as June 1, 2018 and as late as June 1, 2020, on the terms set forth in this RFP to help ENO meet its integrated resource planning objectives, including increased depth and diversity of its generation resource portfolio. ESI also stated in the RFP that it intended to market test a self-build alternative as part of the RFP. Under the provisions of the RFP, physical deliveries of power under a Definitive Agreement entered into pursuant to this RFP must be to MISO (resources directly interconnected to the MISO System) or the “MISO South” portion of the MISO System (LRZ 8, 9, and 10, collectively).

Products solicited include Power Purchase Agreements (“PPA”) for all RFP-eligible technologies and Acquisitions (Solar PV only). The eligible generation technologies permitted for proposals offered into this RFP were commercially proven run-of-river hydro technology, Solar PV technology, and onshore wind technology.

This RFP was limited to resources that were RFP-Eligible Resources. RFP-Eligible Resources are generation resources that:

1. Are Developmental Resources or Existing Resources:
  - a. That will be or are directly interconnected to the MISO System and will physically deliver energy and other products contracted by ENO pursuant to this RFP to the electric interconnection point/CP Node for the resource specified by the Bidder in the applicable proposal or
  - b. That will not be or are not directly interconnected to the MISO System and would physically deliver energy and other products contracted for by ENO pursuant to this RFP to the point in the MISO South portion of the MISO System specified by Bidder in the applicable proposal (either such delivery point, the “Physical Delivery Point”, and
  - c. If from a resource interconnected at a transmission voltage level (69 kV and higher), will be financially settled at the CP Node for New Orleans Load Zone (ESS.NOPLD) (the “ENO Load Node”);
2. Would utilize an RFP-Eligible Technology to make available and generate the products contracted to ENO in any Definitive Agreement arising out of the underlying proposal;
3. Would be a single integrated resource except for multiple Solar PV facilities interconnected at a distribution voltage level (less than 69 kV) (such facilities, collectively, an “Aggregated Solar PV Resource”);

---

<sup>2</sup> ESI acts as agent for Entergy New Orleans, Inc. (“ENO.”)

4. Meet the other requirements for generating resources participating in this RFP.

## **B. Roles and Responsibilities of the Independent Monitor**

Merrimack Energy Group, Inc. was retained by ESI to serve as Independent Monitor for the ENO 2016 Renewable Resources RFP. Merrimack Energy's involvement as Independent Monitor began in the early stages of the RFP development process and continued through final evaluation and selection of the preferred proposal(s). The role of the Independent Monitor was defined in the Scope of Work of the Independent Monitor, which was included under the Reference Tab on the Entergy webpage established for this RFP.<sup>3</sup> During this time, the IM worked closely with ESI's RFP Administrator, RFP Administration Team, and members of the RFP teams. The IM monitored all aspects of the RFP development, administration, evaluation and selection processes. As defined in the Scope of Work, the overriding responsibility of the Independent Monitor was to ensure the competitive bidding process was undertaken in a fair and unbiased manner and that no undue preference was given to affiliates and their bids, self-build or self-supply projects. The major responsibilities of the IM are described later in this report.

This final report meets the requirements for the IM listed in the IM Scope of Work. The report addresses the IM's assessment of the implementation of the key project activities including whether they met the criteria and guidelines established by ESI for undertaking this solicitation and whether the process was undertaken in a fair and equitable manner for the benefit of customers.

Merrimack Energy staff was actively involved in monitoring the process through participation in all major team meetings, conference calls and conversations regarding the decisions about the RFP and solicitation process. The objective of this involvement has been to ensure the process is fair and unbiased and to raise any concerns along the way, if necessary, to ensure the process remained on track to meet these objectives.

Merrimack Energy has no other business relationship (other than as IM) with ESI or ENO or any of their affiliates. However, Wayne Oliver of Merrimack Energy has served in a similar role as Independent Monitor, Independent Evaluator or Independent Consultant on over one hundred competitive procurement processes in 20 states and 3 Canadian Provinces.

## **C. Organization of the Report**

For purposes of undertaking this assessment of the ENO competitive solicitation or RFP process, the following issues will be addressed in this report:

1. A list and description of the Scope of Work of the Independent Monitor;

---

<sup>3</sup>The IM Scope of Work Activities was posted to ENO Website for the RFP in the Reference Tab on May 9, 2016. <https://spofossil.entergy.com/ENTRFP/SEND/2016ENOIRenewableRFP/Index.htm>.



2. Discussion of the various steps or activities associated with the development of the ENO RFP and related documents. This included a discussion of the steps involved in the development of the RFP processes for communicating with bidders, processes and safeguards implemented by ESI to maintain confidentiality of bidder information and development of the bid evaluation criteria and bid evaluation process;
3. A brief description of the contents of the RFP document, including the objectives of the RFP, requirements of the bidders, the proposed evaluation process, and other information;
4. Discussions of the bid receipt process;
5. Process for the review and evaluation of the proposals received;
6. Evaluation and selection of the preferred proposals;
7. Conclusions associated with the ENO RFP process.

## **II. Role and Activities of the IM in the Competitive Bidding Process**

To effectively assess the performance of ESI in developing and implementing a fair and unbiased process, it is necessary for the IM to be actively involved in the process. The major tasks and activities of the IM were described in the IM Scope of Work, which was included on the webpage for the RFP. The activities of the IM can be classified into two categories: (1) process issues and (2) technical issues. The IM was actively involved in both aspects of the assignment.

The proposed activities of the IM throughout the competitive bidding process and the actual tasks and activities performed by the IM was described in Attachment 1 – Scope of Work Activities for Independent Monitor Services Relating to the 2016 Entergy New Orleans, Inc. Request for Proposals for Long-Term Renewable Resources, which is contained on the Website for this RFP.

As noted, the IM was involved in all project phases associated with development of the RFP through bid evaluation, selection and application for approval. Throughout the process, the IM conducted reviews and analyses of ENO and ESI's evaluation results and raised questions about aspects of the evaluation process. One of the objectives of the IM was to ensure that the approaches and methodologies proposed by ENO and ESI were entirely consistent with industry standards and consistent with the protocols and procedures developed and identified by ESI to the bidders. The IM was also focused on ensuring that all cost information for each proposal was appropriately incorporated in the analysis and that all Bidders/proposals were treated fairly and equitably.

### **III. Description of ENO Solicitation Process**

This section of the report provides an overall description of ENO's solicitation process and identifies the major components of the RFP. The traditional stages for development and implementation of a competitive bidding process are first identified. The description of ENO's process is structured as a "chronology" of the key events and issues addressed within the stages of the process, from initiation and development of the RFP documents to selection of the final proposals.

#### **A. ENO's RFP Development Process**

The development process for the ENO RFP was initiated in early 2016. Merrimack Energy was retained in April 2016 to serve as Independent Monitor for the ENO RFP.

##### **Initial Meeting**

A project team kickoff meeting was held between ESI, ENO staff and the IM on April 27, 2016 at ESI's offices. ESI's objective was to provide an overview of the 2016 ENO Renewable RFP solicitation process to the IM. Agenda items for the meeting included:

- Introductions of Project Team members;
- Meeting Objectives;
- RFP Background;
- 2016 ENO Renewable RFP Overview;
- Key Milestones;
- Project Teams;
- Discussion of the Evaluation process;
- RFP Evaluation Overview;
- Process safeguards;
- Independent Monitor Scope of Work;
- General discussion and next steps.

The meeting was designed to be a very interactive process designed to establish a base of information for implementing the RFP process. The IM also relayed his experience in many other renewable energy RFPs as Independent Evaluator or Monitor that may inform the process for the ENO Renewable RFP.

##### **Notice of Intent to Issue RFP**

On March 22, 2016 Entergy Services Inc. provided a notice to interested parties indicating that it intended to issue, on behalf of Entergy New Orleans, Inc. ("ENO"), a Request for Proposals for Renewable Resources. In the Notice, ESI indicated that it anticipated seeking up to 20 MW of renewable resources that could provide cost-effective energy supply, fuel diversity, and other benefits to ENO's customers. Eligible resources would include existing plants and developmental projects utilizing renewable technologies qualified to participate in the RFP. Qualified renewable technologies were

expected to be limited to commercially-proven run-of-river hydro, solar photovoltaic (“Solar PV”), and onshore wind technologies.

Bidders in the RFP would be permitted to submit proposals for Power Purchase Agreements (“PPAs”) for all eligible resources and asset acquisitions of Solar PV resources. The delivery term for a PPA would be a minimum of 10 years and a maximum of 20 years. The guaranteed start date for a PPA and the target closing date of an asset acquisition would be required to be no earlier than June 1, 2018 and no later than June 1, 2020.

The minimum contract capacity offered in any proposal would be 5 MW, except for proposals for Solar PV resources, for which the contract capacity minimum would be 1 MW. The maximum contract capacity offered in any proposal would be 20 MW, unless the proposal was based on aggregated solar PV facilities, in which case the contract capacity maximum would be 5 MW.

ENO indicated it would prefer to contract for resources located in the ENO Load Zone within the Midcontinent Independent System Operator, Inc. (“MISO”) system but would accept proposals for resources located outside of the ENO Load Zone, excluding Aggregated Solar PV facilities, all of which would be required to be located in the ENO Load Zone. For PPA proposals, energy and other products from resources located outside of the ENO Load Zone would be required to be physically delivered to a point on the MISO South transmission system and financially settled at the MISO commercial pricing node for ENO Load. Proposed resources located outside the ENO Load Zone would be required to be electrically interconnected at a transmission voltage level (69kV and up). Proposed resources located within the ENO Load Zone may be interconnected to ENO’s electric grid at either a transmission or a distribution voltage level.

The Notice identified the amount of capacity expected to be solicited, the requirements for participating, and identified the presence of a self-build option in the process of up to 5 MW for Aggregated Solar PV facilities to be located within the ENO Load Zone.

The notice also included a map of the ENO Load Zone and a map of the Exclusion Zone within ENO Load Zone for Distribution-level solar PV resources.

ENO also notified prospective bidders on May 11, 2016 that it intended to hold a Bidders Conference/Webex for the RFP on June 1, 2016. The objective of the Bidders Conference was to give participants a high-level overview of, and other information concerning the RFP and related processes.

In terms of outreach to prospective Bidders, the notice was posted to ESI’s website for the RFP. In addition, the notice was sent electronically to ESI’s lengthy list of suppliers, power marketers and other contacts for ESI RFPs as well as submitting the notice to industry trade publications who would typically post such information such as Platts Megawatt Daily, Power Marketers Association and SNL Energy.

## **ESI Website**

ESI established a website for the ENO 2016 Renewable Resources RFP. The website address was included in the Notice of Intent to issue an RFP and is also included in footnote 2 of this report. The final website included the following tabs:

- Home
- RFP Documents
- Redline Documents (which contain any revisions to the RFP through the course of the process);
- Notification about the RFP
- Reference Information (including Bidders Teleconference presentation, IM Scope of Work, and references to the MISO website)
- Questions and Answers
- Contacts
- Affiliate Rules

## **RFP Safeguards**

From a fairness perspective, one of the concerns often raised by Bidders is an assurance that the utility self-build option does not have an advantage in the solicitation process due to preferential treatment or access to information to which third-party Bidders do not have access. This issue is generally raised in solicitations where a self-build option is allowed to compete. As IM, Merrimack Energy is very sensitive to the safeguards utilized by the host utility and the application of the safeguards to prevent any opportunity for self-dealing between the self-build team and evaluation teams in the process to the competitive detriment of third-party options.

Since it was expected that a self-build generation project would be an eligible option, one of the initial topics of discussion between the ESI Administration Team and the IM during the initial meeting of the team was the safeguards that ESI intended to include in the solicitation process. During discussions ESI informed the IM that the safeguards included procedures to ensure confidential treatment of RFP information and the establishment of protocols that defined who would have access to the specific information, how information would be processed and distributed, and how the process of communications between ESI and the Bidders would be handled. The safeguards that ESI planned to incorporate into the solicitation process included the following:

- Separation of the self-build team from the RFP development and evaluation teams to ensure self-dealing concerns could be eliminated at the very beginning of the process. This process was also designed to ensure that all potential bidders would be treated the same and no bidder would have access to information about the process before any other bidders;
- Application of Confidentiality Agreements (“CA”), as signed by members of all teams, a Code of Conduct, affiliate rules, and Appendix G of the RFP – Process for the Protection of Proposal Information;

- All employees of ESI, any Operating Company, or any Entergy Competitive Affiliate must adhere to the applicable Affiliate Rules and Codes of Conduct;
- ESI personnel involved with the ENO RFP evaluation process would adhere to the provisions of a confidentiality acknowledgement that governs access to and use of information contained in proposals and proposal related documents;
- Designation of an RFP Administrator as a single point of contact to manage RFP communications. Bidders were required to direct all RFP questions, information requests, and other inquiries to the RFP Administrator in writing using the RFP Administrator's dedicated email address included in the RFP Main Body document;
- Development of a dedicated website specifically for the RFP which contained all pertinent RFP information managed by the RFP Administrator. This allowed all prospective bidders to access the website at any time to assist them in decisions about proposal preparation;
- Submission and "lock down" of the self-build option several days prior to submission of other proposals. The self-build proposal was sent to the IM several days before other proposals were due;
- Requirement that the self-build option submit all the same information as other bids to ensure the same information for each proposal is consistently utilized and evaluated;
- Use of Bidder and project ID numbers to distinguish each proposal rather than using and revealing Bidder and project names to some of the evaluation teams, notably the Economic Evaluation Team. The ID numbers were used for purposes of providing information to the project teams for each proposal. The intent of this process element along with redaction of information noted below was to eliminate or minimize any bias in the evaluation if an evaluation team member had other knowledge about a specific project;
- Redaction of bidder names and other information to "blind bids" and ensure there was no possible bias in the evaluation;
- Development of a formal redaction process and information distribution process to the various proposal evaluation teams;
- Inclusion of an Independent Monitor to oversee the process to ensure it was fair and equitable to all Bidders.

The self-build team was by design functionally and physically separate from the RFP teams. The self-build team was composed of employees who essentially operated as the project development group within Entergy. Members of the self-build team and any individuals supporting them were required to sign Confidentiality Agreements detailing any restrictions regarding information or other activities affecting them and the requirement that they abide by the same processes and requirements as any third-party.

One of the recommendations made by the IM based on experience with other solicitations was that in any case where a meeting or discussion would occur between any members of the self-build team and RFP Administration or Evaluation team members regarding the RFP, that the IM would be present, either via telecon or in person to monitor any

discussions. The RFP Administrator indicated that this was a common practice adopted by ESI for such solicitations.

The application of safeguards to ensure that the self-build option or company bid had no inherent advantage in the solicitation process was important for eliminating any concerns by prospective bidders over self-dealing. ESI identified a comprehensive list of safeguards that it planned to include in the solicitation process.<sup>4</sup>

### **RFP Project Team Roles and Responsibilities**

The ENO solicitation process involves a detailed organizational plan to structure different project teams with roles and responsibilities at the initiation of the solicitation process. Table 1 provides a list of the various teams involved in the process along with their roles and responsibilities as provided to the IM.

**Table 1: Roles and Responsibilities of RFP Project Teams**

<b>Team</b>	<b>Responsibilities</b>
RFP Project Sponsors	Ensured the RFP scope met ENO’s overall resource supply needs and requirements. Ultimately makes the resource selection as a member of the approving Entergy Operating Committee.
OPCO Support	Provides Operating Company oversight and ensured the RFP met the overall resource supply needs and requirements for each Operating Company participating in the RFP
RFP Project Manager	Established and coordinated overall project plan and deliverables needed to execute the RFP. Developed project timelines, managed document development, and provided updates to OPCO Support and Management as needed. Served as the primary liaison between ESI and bidders, coordinated the bidder registration and proposal submission process, ensured evaluation teams received appropriate data reports, and provided RFP planning support.
RFP Administration Team	Provided technical oversight and project management guidance to ensure processes and documents were structured to meet ENO’s objectives for the RFP in a timely manner that complied with the RFP protocols. Established and coordinated the overall project plan and deliverables needed to execute the RFP. Developed project timeline and managed document development. Ensured information was managed and communicated in accordance with RFP protocols in order to ensure resources were selected on a fair and impartial basis and in accordance with ENO’s objectives for the RFP. Team had access to all raw bid data to adequately provide information to evaluation teams and general oversight.
Economic Evaluation Team (EET)	Assessed the extent to which proposals provided economic benefits, considering risks.
Production Cost/Aurora Team	The Aurora Team would run AURORAxmp Electric Market Model (Aurora); relied on production cost modeling to assess operating

<sup>4</sup> The IM was actively involved in designing the Framework for Competitive Bidding in Hawaii, including the safeguards to ensure the process was a fair and equitable process for all Bidders and is very familiar with the safeguards adopted throughout the industry, including those safeguards included in Bidding Rules or Guidelines adopted in a number of states. ESI’s list of safeguards utilized generally exceeded industry practices.

	projections, and the energy value of each conforming proposal.
Viability Team (VAT)	Identified fatal flaws or risk elements that limited a proposal's ability to meet relevant planning objectives, interconnection, commercial terms and the needs and requirements of the RFP. Consisted of sub-teams that included Commercial Operations, Planning Assessment, Renewable SME, Operations team, Deliverability assessment, and other support subject matter areas.
Credit Team	Determined the maximum uncollateralized supplier exposure/credit risk as well as the required forms of collateral to be accepted for selected proposals.
Accounting Team	Reviewed each proposal to determine the accounting treatment and impact the proposal had on ENO.
Regulatory and Legal Support	Provided guidance and input to ensure the RFP was structured in a fair and impartial manner; supported activities associated with seeking regulatory approval and cost recovery; provided a leadership role in negotiations.

As noted, ESI designated an RFP Administrator for the RFP. The responsibilities of the RFP Administrator included: (1) act as a liaison between the participants in this RFP and ESI on all RFP-related matters; (2) ensured that Bidder questions ESI receives were addressed in an appropriate manner; (3) received, recorded, and maintained bidder proposals; (4) interacted with the IM; and (5) managed other administrative matters relating to this RFP.

#### **ESI Bidders Teleconference/Webcast**

ESI held a Bidders Conference on June 1, 2016 for the 2016 RFP for Long-Term Renewable Generation Resources. The topics addressed included:

- RFP overview and scope review
- Role of the IM
- Tentative RFP schedule
- Bidder registration and proposal submission process and requirements
- Commercial terms
- RFP Evaluation Overview
  - Commercial terms
  - Interconnection and deliverability
  - Viability assessment
  - Economic evaluation
  - Accounting evaluation
  - Credit evaluation
- Process safeguards
- Q&A Session

ESI also provided a tentative schedule for the solicitation process. The schedule noted that comments to draft documents were due on June 22, 2016 with the final RFP documents expected to be issued on July 13, 2016.

The presentation included the following table which summarized and outlined the scope of key RFP elements for the information of the Bidders.

**Table 2: Summary and Description of Key RFP Elements**

<b>RFP Elements</b>	<b>Description</b>
RFP Eligible Resources	<ul style="list-style-type: none"> <li>• New</li> <li>• Existing</li> </ul>
RFP Eligible Technology	<ul style="list-style-type: none"> <li>• Run-of-River hydro</li> <li>• Solar Photovoltaic (PV)</li> <li>• Onshore Wind</li> </ul>
Capacity and Energy Sought	<ul style="list-style-type: none"> <li>• RFP Capacity Sought: up to 20 MW</li> <li>• Proposals for Non-Aggregated Resources <ul style="list-style-type: none"> <li>○ Max capacity per proposal: 20 MW</li> <li>○ Min capacity per proposal for onshore wind or hydro: 5 MW</li> <li>○ Min capacity per proposal for Solar PV: 1 MW</li> </ul> </li> <li>• Proposals for Aggregated Solar PV Resources <ul style="list-style-type: none"> <li>○ Max capacity per proposal: 5 MW</li> <li>○ Min capacity per proposal: 1 MW</li> </ul> </li> </ul>
Physical Location	<ul style="list-style-type: none"> <li>• Transmission <ul style="list-style-type: none"> <li>○ Not prescribed but ENO generally prefers: <ul style="list-style-type: none"> <li>▪ Resources located in ENO load zone (Orleans Parish)</li> <li>▪ Then, in LRZ 9</li> <li>▪ Then, in MISO South</li> <li>▪ Then, in MISO</li> <li>▪ Then, outside MISO</li> </ul> </li> </ul> </li> <li>• Distribution <ul style="list-style-type: none"> <li>○ Must be located within the ENO load zone</li> </ul> </li> </ul>
Deliverability	<ul style="list-style-type: none"> <li>• Resources outside of the ENO Load Zone must be physically delivered to a point on the MISO South transmission system and financially delivered to the ENO load zone.</li> </ul>
Interconnection Size Requirements	<ul style="list-style-type: none"> <li>• Transmission Voltage Interconnections: 1 MW to 20 MW (AC)</li> <li>• Distribution Voltage Interconnections: 100 kW to 10 MW (AC)</li> </ul>
Start Date	<ul style="list-style-type: none"> <li>• As early as June 1, 2018 but no later than June 1, 2020</li> </ul>
Product Categories	<ul style="list-style-type: none"> <li>• PPA (all eligible technologies)</li> <li>• Acquisition (Solar PV only)</li> </ul>
PPA Term	<ul style="list-style-type: none"> <li>• 10 – 20 years</li> </ul>
Commercial Terms	<ul style="list-style-type: none"> <li>• PPA: All-in energy only (no indexing)</li> <li>• Acquisition: Total \$</li> </ul>



A total of 27 participants representing 18 potential bidders as well as representatives from ESI and ENO registered for the Bidders Conference.

### **Comments on the Draft RFP**

Comments on the draft RFP were due on June 22, 2016. Comments were submitted by four parties: Southern Wind Energy Association (SWEA), Clean Line Energy Partners, Invenergy, and Entergy Services.

Southern Wind Energy Association provided an overall perspective on the availability of wind energy to the ESI system. SWEA submitted three recommendations:

- ENO should expand the size of the RFP to at least 100 MW of renewables;
- ENO should expedite the RFP to gain approvals by the end of 2016;
- ENO should allow PPA terms greater than 20 years.

Clean Line Energy Partners provided the following recommendations:

- Increase the procurement of renewables beyond the 20 MW identified in the RFP;
- Accelerate timing of the RFP to align with the Production Tax Credit (“PTC”) phase-out;
- Expand the scope of the RFP to include proposals for the ownership of wind energy assets;

Invenergy submitted a number of comments focused specifically on the PPA included in Entergy’s RFP documents which were posted on the website.

Entergy Services submitted comments on behalf of ENO focused primarily on suggesting clarification of three provisions of the RFP primarily dealing with distributed generation.

### **Issuance of Final RFP**

On July 13, 2016, ESI issued the 2016 RFP for Long-Term Renewable Generation Resources for Entergy New Orleans, Inc. and posted the documents associated with the RFP to its website. The RFP documents posted to the website on July 13, 2016 included the following:

- 2016 ENO Renewable RFP Main Body – RFP Instructions
- Appendix A (Glossary)
- Appendix B-1 (Term Sheet PPA)
- Appendix B-2 (Term Sheet for Asset Acquisition)
- Appendix C-1 Questions and Information Requests from Bidders for Developmental Resources
- Appendix C-2 Questions and Information Requests from Bidders for Existing Resources
- Appendix D (Minimum Requirements)
- Appendix E (Reservation of ESI Rights and Other RFP Terms)
- Appendix F (Credit/Collateral Requirements)

- Appendix G (Process for Protection of Proposal Information)
- Appendix H (Documents that describe the process for interconnecting to the ENO electric distribution system)
- Bidder Registration Agreement
- Form of Confidentiality Agreement
- Proposal Submission Agreement
- Viability Self-Assessment (Long-Term and Limited Term RFPs)
- Proposal Submission Template

A few of these Appendices are worth elaborating on given their importance in the proposal development and evaluation process. For example, Appendices C-1 and C-2 (Due Diligence List) contained questions and requests for information or material that Bidders will be required to answer or provide in connection with any proposal submitted into this RFP (Appendix C-1). Information was requested in the following categories:

- Project Overview
- Bidder Experience
- Project Development
  - Engineering
  - Project schedule
  - Cost estimate
  - Site control and assessment
  - Facility and equipment
  - Operation and maintenance
  - Contract status
- Electrical Interconnection and transmission
- Fuel supply and transportation
- Environmental
- Project structure and finance
- NERC/CIP compliance

Much of this information would be used by the VAT team to conduct its due diligence and project viability assessment for each proposal.

The Proposal Submission Template was another important document. The Proposal Submission Template contained the following tabs:

- Proposal and operational information
- Hourly Profile Template
- PPA Pricing
- Pricing – Acquisition (Solar PV)
- Special Considerations<sup>5</sup>

---

<sup>5</sup> The Special Considerations Tab allowed bidders not wishing to agree to a term or condition set forth or described in the RFP to identify the specific term or condition to which Bidder takes exception and provide a reasonably complete and detailed explanation of the Bidder's position. Bidders could also include any special operational conditions associated with their project or identify any constraints. Submission of an

This document included the pertinent pricing and operational information that the Economic Evaluation Team and Aurora teams would use in their evaluation. In addition, the Special Considerations section allowed Bidders to include any special operational conditions associated with their project or identify any constraints.

The final important document for bid evaluation was the Viability Self-Assessment Form. This Form requested the following information provided by the project sponsor:

- Resource Overview
- Technical Feasibility
- Bidder Experience
- Development Status
- Commercial
- Site Assessment
- Permits
- Project Financing

Merrimack Energy reviewed these documents and forms to ensure the information that was requested by ESI was used in the bid evaluation process and that the evaluation criteria and information requested were closely linked. In other words, based on the evaluation criteria established, does the information requested allow the analysts the ability to effectively evaluate all the proposals consistently?

**RFP Summary**

The 2016 ENO Renewable Resources RFP documents, including the Main Body, were posted on the website by ESI on July 13, 2016. In addition to posting the RFP documents to its website, Entergy also sent an email to its contact list for similar RFPs and also issued the notice to trade publications.

A summary of the key parameters and requirements for the products solicited in the RFP Main Body is provided in Table 3. Included in this Table was a further description of the components of the RFP, including requirements of Bidders, eligibility requirements, evaluation process, and other important provisions included in the Main Body document.

**Table 3: Summary of the Products Solicited**

<b>Scope Item</b>	<b>2016 Renewable Energy RFP</b>
Products Solicited	PPAs (all RFP-Eligible Technologies) and acquisitions (Solar PV only) (See Section 2.2, Appendices B-1 and B-2)
Permitted Start Dates	From June 1, 2018 to June 1, 2020 (See Section 2.2.2); ENO preferred delivery start and termination dates that coincided with the start and termination of MISO planning periods

---

exception did not mean ENO would accept (and ENO is under no obligation to accept or agree to, in whole or in part) any exception noted below in any negotiation of a definitive agreement.

RFP Capacity Target	Up to 20 MW in the aggregate (See Sections 1.1, 2.1, 2.2)
Proposal Capacity Requirements and Limitations	<ul style="list-style-type: none"> <li>• Minimum contract Capacity for any resource except a Solar PV resource: 5 MW</li> <li>• Minimum contract Capacity for a Solar PV resource: 1 MW (AC)</li> <li>• Minimum capacity for any individual generating station that is part of an Aggregated Solar PV Resource: 100 kW (AC) (collectively, the “Contract Capacity Minimums”)</li> <li>• Maximum contract Capacity for any one resource: 20 MW</li> <li>• Maximum contract Capacity for an Aggregated Solar PV Resource: 5 MW (AC) (collectively, the Contract Capacity Maximums”) (See Sections 2.1, 2.2)</li> </ul>
Eligible Technologies	<ul style="list-style-type: none"> <li>• Run-of-river hydroelectric technology</li> <li>• Solar Photovoltaic (Solar PV) technology</li> <li>• Onshore wind technology</li> </ul>
Eligible Resources	<ul style="list-style-type: none"> <li>• Except for resources interconnected at a distribution voltage level, a location for resources sought in this RFP was not prescribed, but ENO generally preferred, in order of preference, resources located in the ENO Load Zone, then in LRZ 9, then in MISO South, then MISO, and then outside MISO</li> <li>• Resources interconnected at a distribution voltage level (including each individual generating station forming part of an Aggregated Solar PV Resource) must be located within specified portions of the ENO Load Zone</li> <li>• Solar PV resources offered in an acquisition proposal must be located in the ENO Load Zone (see Sections 1.2, 2.3, 2.4)</li> </ul>
Eligible Participants	<ul style="list-style-type: none"> <li>• Eligible Participants include other electric utilities, marketers, wholesale generators, electric cooperatives, independent power producers, and QFs that would be capable of meeting the conditions and requirements identified in the RFP. Entergy competitive affiliates were ineligible to participate in the RFP.</li> </ul>
Other Eligibility Requirements	<p>Other Eligibility requirements include:</p> <ul style="list-style-type: none"> <li>• PPA pricing would be based on an energy rate (expressed in \$/MWh), which would be either fixed for the entire Delivery Term or defined annually. A PPA proposal’s pricing must reflect an “all-in” energy price (including all related fees and expenses) that ENO would pay to Seller for all products associated with the provision, generation, and delivery to ENO of energy, Environmental Attributes, Capacity, capacity-related benefits, and other electric products;</li> <li>• The Delivery Term for PPAs would be be a minimum of ten (10) years and a maximum of twenty (20) years;</li> <li>• To be eligible to submit a proposal, a Bidder must complete the Bidder Registration process;</li> </ul>

	<ul style="list-style-type: none"> <li>• Bidders were required to pay a Proposal Submittal Fee of \$5,000 for each registered proposal;</li> <li>• Bidders must provide a complete Proposal Package as listed in the RFP;</li> <li>• PPAs would include guaranteed annual energy delivery minimums entitling ENO to liquidated damages if the minimums were not met and to terminate the PPA for specified failures to meet energy delivery minimums over any two consecutive contract years or any three contract years (whether or not consecutive);</li> <li>• For Acquisitions, Bidders were required to provide a purchase price which must be expressed as a single fixed payment for the proposed acquisition and should exclude any investment tax credit or bonus depreciation value potentially transferrable with the resource;</li> </ul>
<p>Threshold Requirements</p>	<ul style="list-style-type: none"> <li>• Any proposal not meeting the Threshold Requirements would be considered non-conforming and may be eliminated from further consideration in this RFP by ESI, after consultation with the IM. The threshold requirements were listed in the RFP:           <ul style="list-style-type: none"> <li>○ Pricing offered in a proposal must be energy-only or a single fixed payment (acquisitions).</li> <li>○ Delivery assessment threshold requirements               <ul style="list-style-type: none"> <li>▪ Seller would be required to have obtained for the proposed resource prior to commencement of the Delivery Term, interconnection, deliverability, and firm transmission or distribution service to the Physical Delivery Point;</li> <li>▪ For existing or developmental resources that would be directly interconnected to the MISO transmission system, Sellers would be required to have obtained ERIS and NRIS, with the amount of ERIS obtained equal to the amount of the capacity of the facility;</li> <li>▪ For existing or developmental resources not directly interconnected to the MISO transmission system, Sellers would be required to obtain both interconnection service and firm deliverability/transmission service from the applicable resource to the Physical Delivery Point in amount sufficient to enable Seller to deliver at least the maximum amount of contract energy that Seller may deliver to</li> </ul> </li> </ul> </li> </ul>

the Physical Delivery Point;

- Viability assessment threshold requirements include:
  - Bidder must be an Eligible Participant;
  - The resource supporting a Bidder's proposal must be an RFP-Eligible Resource;
  - For Developmental proposals, Bidders must meet the applicable Minimum Requirements for Developmental Resources as set forth in Appendix D;
  - For Developmental Resource proposals, the resource must be free of fatal design flaws and/or non-standard operational or permitting restrictions that would reasonably be expected to prevent it from meeting the requirements of this RFP;
  - For proposals offering a PPA Product, the proposed Delivery Term must be no less than 10 years and no more than 20 years and be proposed no earlier than June 1, 2018 and no later than June 1, 2020;
  - For Developmental Resources, Bidders offering a proposal must provide an hourly generation profile and explain how it was derived;
  - Resources interconnecting at a distribution voltage level must be located within the ENO Load Zone and not require more than 10 MW of interconnection service;
  - The proposed resource must be eligible to qualify as a Long-Term Network Resource (if interconnected at a transmission level) or a Load Modifying Resource (if interconnected at a distribution level);
  - For resources interconnected at a transmission level, Bidders must provide the interconnection, deliverability, and transmission service documentation for their proposals.
  
- Accounting Assessment Threshold Requirements
  - The Bidder must include in the Proposal Package the accounting certification required in this RFP;
  
- Credit Assessment Threshold Requirements
  - Bidder must provide the most recent Published

	<p>Credit Rating of Bidder, or, if different from Bidder, Seller (from S&amp;P and Moody's) to the extent such a rating exists;</p> <ul style="list-style-type: none"> <li>▪ Bidder must provide the annual audited financial statements for the past two years and the current year quarterly financial statements;</li> <li>▪ If a Bidder proposes a Credit Support Provider, the above information requirements apply to the Credit Support Provider.</li> </ul>
Interconnection Size Requirements	<ul style="list-style-type: none"> <li>• Transmission voltage interconnections: 1 MW to 20 MW</li> <li>• Distribution Voltage Interconnections: 100 kW to 10 MW (see Section 2.4, Appendix D)</li> </ul>
Physical Deliveries (PPAs)	<ul style="list-style-type: none"> <li>• Product contracted for purchase from resources not directly interconnected to the MISO System must be physically delivered to MISO South</li> <li>• Products contracted for purchase from resources directly interconnected to the MISO System must be physically delivered to the electric interconnection point/CP Node for the resource within MISO (See Sections 1.9, 2.4)</li> </ul>
Financial Settlement (PPA)	<p>ENO purchases from resources interconnected at a transmission voltage level would be financially settled at the ENO Load Node and Seller would be responsible for any basis differential and all related costs between the applicable product price at the Physical Delivery Point and the product price at the ENO Load Node. ENO purchases from resources interconnected at a distribution voltage level were expected to be financially settled at the Physical Delivery Point (See Sections 1.9, 2.4.3)</p>
Delivery Term for PPAs	<p>Minimum: 10 years  Maximum: 20 years</p>
Self-Build	<p>A developmental Aggregated Solar PV Resource of up to 5 MW (AC) that would be sited entirely within permitted locations in the ENO Load Zones (see Section 2.6, 3)</p>
Evaluation Process	<p>Section 6 of the ENO RFP provides a description of the evaluation process. The evaluation process would be conducted in two phases. In Phase I, proposals would be assessed for compliance with the Threshold Requirements. Proposals remaining in this RFP after the Threshold Requirements compliance review would then be evaluated in Phase I to identify the most economic proposals and significant high-level risks or RFP nonconformities associated with such proposals. Based on the Phase I evaluation results, ESI may reduce the number of proposals under consideration and may develop a preliminary shortlist of proposals. Phase I would end after the completion of the Phase I evaluation of proposals and the establishment of the Shortlist or the determination by ENO that the</p>

	Shortlist is not necessary for this RFP. In Phase II of this RFP, proposals placed on the Shortlist or otherwise remaining in this RFP would be evaluated in greater detail. Applying qualitative and quantitative assessments, the proposals in Phase II would be assigned a proposal ranking and a recommended disposition. A final list setting forth the proposals selected for negotiation of a Definitive Agreement and the proposals selected for possible negotiation of a Definitive Agreement would be created.
RFP Schedule	<ul style="list-style-type: none"> <li>• Final RFP Document Issued – July 13, 2016</li> <li>• Self-Build Option Deadline – September 30, 2016</li> <li>• Proposal Submission Period – October 3-6, 2017</li> <li>• Primary/Secondary Selection Lists Announced – April 2017</li> <li>• Definitive Agreements Executed – September 2017</li> <li>• Regulatory Approval Process Complete – September 2018</li> </ul>
Other RFP Provisions	<ul style="list-style-type: none"> <li>• The RFP document included a complete schedule for the solicitation;</li> <li>• The RFP provided a complete description of the proposal submission requirements;</li> </ul>

**RFP Administration Team**

ESI designated an “RFP Administrator” and RFP Administration Team for each solicitation. As described in the RFP Main Body document, the RFP Administration team would act to ensure that each Evaluation Team had the information needed to perform its analysis and act to facilitate the evaluation of proposals by all Evaluation Teams so that the evaluation process results in the proper assessment of the economics and other relevant elements of the proposals. The RFP Administration Team would also prepare and distribute the results of the RFP to appropriate individuals at ENO and ESI and may recommend to ENO the placement of proposals on the Primary Selection list or Secondary Selection list or the elimination of proposals. Each of the Evaluation Teams, the RFP Administration Team, and the RFP Administrator would have the right to ask Bidders clarifying questions or request additional information that it believed may help the evaluation process.

The RFP Administrator’s responsibilities included (1) act as liaison between the Participants in the RFP and ESI on all RFP-related matters; (2) ensure that Bidder questions that ESI received were addressed in an appropriate manner; (3) received, recorded, and maintained Bidder proposals; (4) interacted with the IM, and (5) managed other administrative matters related to the RFP.

**Roles and Responsibilities of the RFP Proposal Evaluation Teams**

The proposal evaluation process in this RFP was carried out by six evaluation teams. These include the following:



- The Economic Evaluation Team (“EET”)
- The Production Cost Assessment Team (“PCAT”)
- The Viability Assessment Team (“VAT”)
- The Delivery Assessment Team (“DAT”)
- The Accounting Evaluation Team (“AET”) and
- The Credit Evaluation Team (“CET”)

The role of the teams is summarized in this section.

The EET conducted an economic evaluation of proposals to identify the proposals submitted in the RFP that economically met ETI’s supply needs, considering risk. EET was responsible for evaluating the economics of proposals received with inputs from other project teams such as PCAT, DAT, VAT, CET and AET. The EET’s economic evaluation estimated the all-in economic cost and benefit to the Company’s customers of each proposal evaluated.

The VAT team reviewed and assessed the technical, environmental, interconnection, deliverability, transmission, energy supply source, and commercial merits of the proposals. The VAT team included subject matter experts within the company associated with each of the evaluation criteria focus areas.<sup>6</sup> The subject matter expert in a specific area was responsible for providing an overview and assessment of each proposal with respect to their area of expertise.

The DAT was a sub-team of VAT and was responsible for conducting the deliverability evaluation process in this RFP. As part of the deliverability evaluation, the DAT may assessed interconnection, deliverability, and transmission elements of a proposal offered into this RFP, including resource location, electric interconnection, network deliverability, and status of interconnection, transmission, and deliverability service requests or applications.

The Credit Evaluation Team (CET) analyzed each proposal (except the self-build) to assess potential credit risks and attendant collateral requirements. The CET’s evaluation sought to assure that the credit quality of the Bidder (or, if different, Seller), when considered in light of its RFP proposal(s), complied with Entergy’s corporate risk management standards.

The AET team performed an assessment of each proposed Definitive Agreement for a PPA to determine the accounting treatment of the PPA proposed. AET assessed the proposed PPAs offered into the RFP to determine the relevant accounting treatment with respect to such proposal, including, lease accounting, Variable Interest Entity (VIE) accounting, and Derivative accounting.

---

<sup>6</sup> These include Plant and Equipment, Operation and Maintenance, Commercial terms, Environmental and Permitting, Fuel Supply and Transportation, Long-Term Planning, and other areas as required.

## **Self-Build Option**

In its RFP document, ESI noted that it intended to develop and submit into the RFP a cost estimate for a Self-Build Option. The RFP noted that the Self-Build Option would be an Aggregated Solar PV Resource that would have a total capacity of up to 5 MW (AC). Each individual Solar PV resource comprising a portion of the Self-build option would be at least 100 kW (AC), located at a site within Orleans Parish, Louisiana, and interconnected at a distribution voltage level of at or less than 13.2 kV on ENO's side of the electric meter. The self-build option was expected to utilize existing buildings and properties, including customer-owned and ENO or Affiliate-owned sites.

The Self-Build option would be considered an alternative to, or in conjunction with, third-party proposals submitted into the RFP. If one or more third-party resources was selected for contract negotiations, ENO may continue to take the steps necessary to preserve the Self-build option as a viable option in case negotiations with any third party did not lead to a Definitive Agreement. If selected in the RFP, the self-build resource was expected to be placed into commercial service by no later than June 1, 2020.

From a safeguards perspective, the team that prepared the self-build option was composed of employees dedicated to the self-build option. While the self-build team was generally located within the same Entergy building in The Woodlands, Texas the team was functionally separate and physically (different floors) separate from the RFP Administration and other evaluation teams. Members of the self-build team were designated as such prior to the notification of the RFP and signed confidentiality agreements.

The RFP required the Self-build team to submit a completed proposal based on the same information required of all other Bidders to the RFP Administrator and the IM prior to receipt of proposals from other Bidders. For this RFP, the Self-build option was due on September 30, 2016, prior to the scheduled submission period for other Bidders of October 3 - 6, 2016. The IM received the Self-build proposal as required prior to submission of other proposals.

## **Evaluation Methodology**

From the issuance of the RFP to shortly before proposals were due the Entergy teams were focused on developing the economic evaluation methodology and inputs and the VAT scorecard to evaluate the viability criteria associated with each proposal. Several conference calls were held between the Entergy teams and the IM in August and September 2016 to review the status of the evaluation methodology for both the PPA and acquisition options. One of the focuses of the IM was to ensure EET properly included the Investment Tax Credit ("ITC") benefits in its modeling of the self-build and acquisition options to address normalization accounting requirements applied to utility ownership of solar projects subject to the ITC. Merrimack Energy confirmed that the modeling of the ITC benefits for utility-owned projects was reasonable and appropriate.

ESI developed a multi-phase process for the economic evaluation including evaluating and selecting proposals. Phase I included the period from the receipt of proposals through selection of the preliminary shortlist. The purpose of this phase of the evaluation was to identify the most economic proposals for preliminary shortlist consideration. During this phase, ENO conducted an economic threshold screening assessment based on a net benefit analysis using spreadsheet models. The net benefit of a proposal would be determined by subtracting the total fixed costs and variable costs from the projected capacity and energy revenues. Proposal costs were expected to be the primary driver of the Phase I analysis. Evaluation results would be measured on an NPV (million \$) and levelized on a real \$/kW-year basis over the proposal delivery term. Shortlist selection would include the results of the economic evaluation and would also include inputs from all evaluation teams. The result of this phase would be a preliminary shortlist of proposals.

For the Phase II detailed evaluation, shortlisted proposals would be evaluated in greater detail. In addition to the Net Benefit analysis methodology used in Phase I, the Phase II economic analysis may utilize a production cost model (Aurora) to assess the effects of each proposal on total ENO variable costs if applicable. Final selections would also incorporate the inputs from all evaluation teams. Sensitivity and/or scenario analysis may be performed as needed. The result of this Phase would be a selection of the primary proposals as well as secondary selections.

For Phase II, ENO reserved the right to review the special considerations listed by the bidders and make adjustments to the economic threshold screening results based on its assessment of the special considerations.

For the economic evaluation, the EET team was initially focused on developing generic solar PV and wind production profiles for use in the ENO renewable RFP screening level economic evaluations.<sup>7</sup> For the detailed evaluation, EET sought to confirm the detailed production profiles generated by the bidders.

### **Question and Answer Period**

Questions were submitted during and after the Bidders Conference. ESI posted responses to questions as they were submitted. The final Questions and Answers were posted on or around the bid due date. A total of 18 Q&A's were posted on the website.

The IM generally felt that ESI responded to the questions with fairly detailed responses and in sufficient detail to provide a reasonable base of information in response to the questions.

---

<sup>7</sup> This analysis relied on data generated by National Renewable Energy Laboratory's System Advisor Model (NREL SAM), which is an industry accepted software developed in conjunction with Sandia National Laboratories and the DOE. For New Orleans, a single profile was developed based on the MSY weather station.

### **Bidder Registration Period**

The Bidder registration period was scheduled for August 29, 2016 to September 1, 2016. A Bidder was required to complete the Bidder Registration Process to be eligible to submit a proposal. To register for the RFP, all Bidders, including those sponsoring the Self-Build Option were required to complete a Bidder Registration Agreement (including the Bidder Registration Form).<sup>8</sup> Only Registered Bidders would be permitted to submit proposals into the RFP.

Following submission of its completed Bidder Registration Agreement, Bidders would be issued a unique Bidder ID number. Also, each registered resource and proposal would receive its own Resource ID and Proposal ID. The ID numbers were to be used by the Bidder as identification of its project when submitting information to ESI. The use of ID numbers instead of the identification of the Bidder or project name was designed to ensure that appropriate protections were in place to minimize the dissemination of information that explicitly identifies Bidders to Evaluation Team members who did not need to know that information. The use of Bid numbers in combination with redaction of bidder names and project information was designed to ensure the bid evaluation process was as generic or neutral as possible.

Bidders were also required to pay a Proposal Submittal Fee of \$5,000 for each proposal registered. ESI billed the Bidder the total Proposal Submittal Fees following the end of the Registration Period.<sup>9</sup>

Twelve prospective Bidders, including the Self-Build option submitted Bidder Registration Agreements for a total of nineteen (19) prospective proposals overall. Eighteen of the prospective proposals were for solar PV projects and one was for a wind project. Sixteen (16) prospective proposals were for PPAs and two for acquisitions. One was undecided. A summary of the Registration information is included in Table 4.

**Table 4: Summary of Registered Bidders**

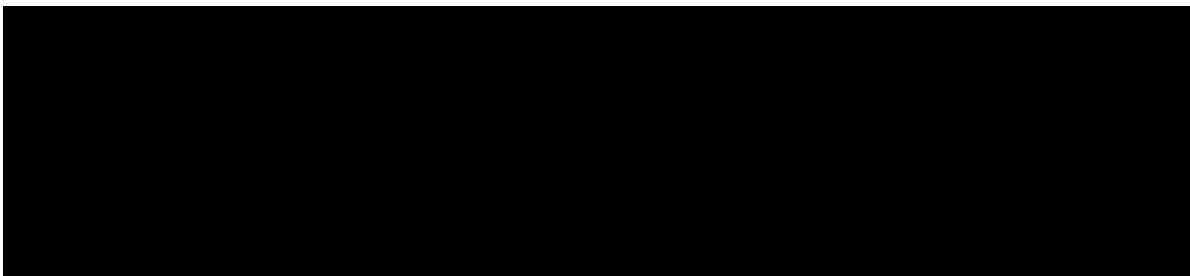
A large black rectangular redaction box covers the content of Table 4, which would have provided a summary of registered bidders.

<sup>8</sup> The Bidder Registration Form requested the following information from the prospective Bidder: (1) Bidder Name; (2) Bidder Contacts; (3) Generation Facility name; (4) Facility location; (5) Owner of facility; (6) Proposal type (i.e. PPA, Acquisition); (7) Number of proposals Bidder intended to submit; (8) technology type; (9) resource type.

<sup>9</sup> Proposal fees would be refunded to Bidders only under the following circumstances as described in the RFP: (1) Bidder registers a proposal and pays the fees but does not complete the proposal submission; (2) Bidder registers a proposal but withdraws the proposal prior to the Proposal Submission deadline; (3) ESI cancels or terminates the RFP prior to selection of proposals.

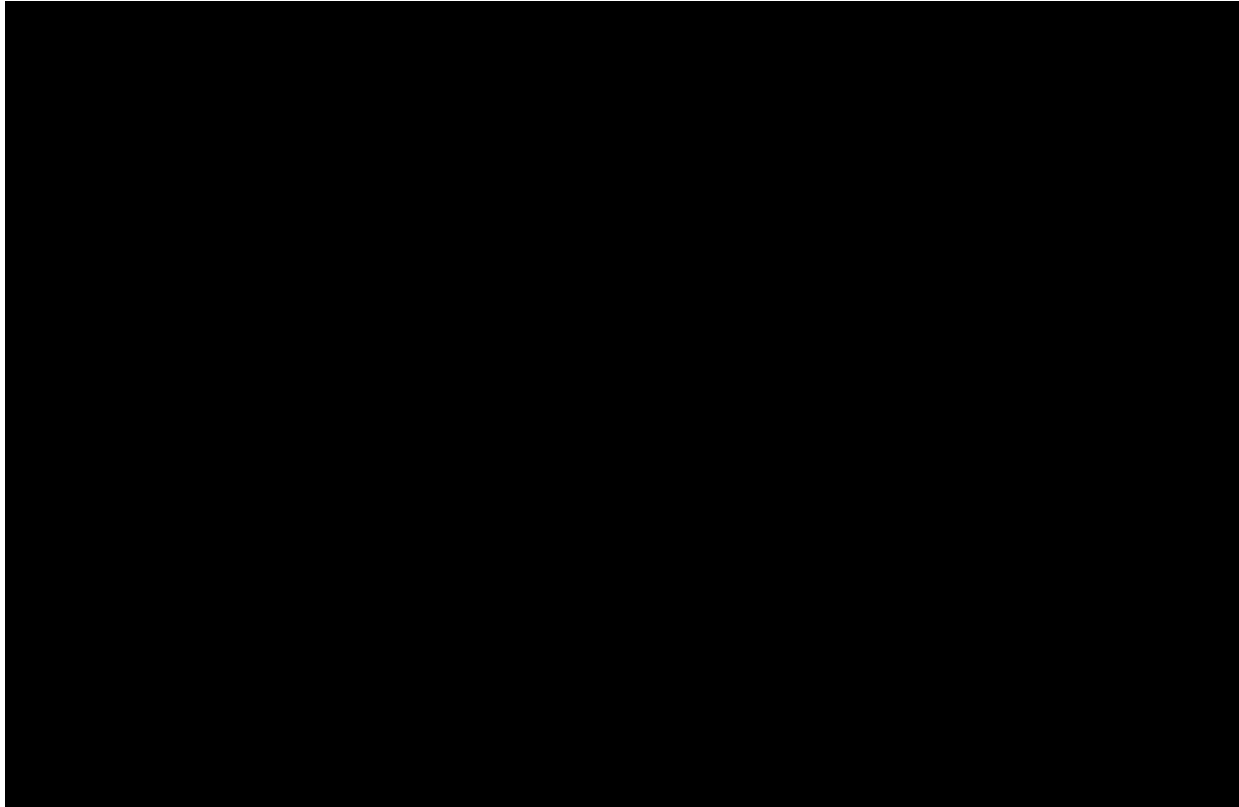

One bidder [REDACTED] did not pay its bid fees and was not eligible to submit a proposal. Another bidder [REDACTED] withdrew its registration. Seventeen proposals from 10 bidders were formally registered.

ESI also established an “RFP Hotline” for Bidders throughout the Bidder Registration Period and Proposal Submission Period. Through the Hotline, Bidders were able to ask technical questions or other questions regarding registration or the Proposal Submission Process. The Hotline was another safeguard to allow Bidders the opportunity to raise questions and receive a quick response during a crucial period of proposal development. The Hotline was not accessed for the ENO RFP process.

#### **Evaluation Team Meeting with IM**

ESI organized a meeting for the IM and ENO Project team on September 19, 2016, shortly before bids were due. One of the objectives of the meeting was to discuss the role of each team in the evaluation process in preparation for receipt of proposals, review of proposals in each stage of the evaluation and evaluation of the proposals eligible to compete. In addition, another intent of the meeting was to lock down the model to be used to conduct the economic evaluation of the bids. The agenda for the meeting included:

- A. Overall Evaluation Process
- B. Viability Team presentation
- C. Deliverability Assessment Team presentation

- D. Economic Evaluation Team presentation
- E. Action Items/Next Steps

The evaluation teams identified above described their roles and responsibilities in the evaluation process. Proposals would be reviewed and assessed for the following factors:

- Economics (Net Supply Cost)
- Transmission/Delivery
- Project Viability
- Credit and Collateral Requirements
- Accounting Treatment

The roles and responsibilities of each team as well as their evaluation processes were discussed in detail at the meeting. In addition, each team also presented a status report on preparation of their evaluation methodologies to date. This was particularly focused on the status of the economic and project viability assessments. The Economic Evaluation team was in the process of completing and locking down its Economic Evaluation model prior to submission of proposals while the Project Viability team was preparing a “scorecard” for purposes of review and evaluation of proposals. The IM had the opportunity to review and comment on the methodologies and tools used for the evaluation process from early on in the development phase. The IM was provided with a preliminary version of the model for review and comment. The objective of all the teams was to “lock-down” the methodologies and assumptions prior to receipt of proposals. The “locked-down” economic evaluation model was sent to the IM before receipt of RFP proposals.

The economic evaluation methodology was one of the focuses of the discussion. ESI team members discussed the proposed methodology, the metrics that would be used for the evaluation and the suggested normalization approach to ensure all proposals were evaluated over a consistent timeframe.

## **B. Proposal Submission Period**

### **Proposal Submission**

ESI received seventeen proposals from ten Bidders. Sixteen of the seventeen proposals were for Solar PV facilities and one was for a wind project. Fifteen of the proposals were for PPAs from third-parties, while two of the proposals were for acquisitions of projects that would be owned by ENO, including one self-build option.

The Self-build proposal was submitted to ESI and the IM on September 30, 2016 as required. The remaining proposals from third-parties were submitted between October 3, 2016 and October 6, 2016. The proposals submitted are summarized in Table 5.

**Table 5: Summary of Proposals Received**

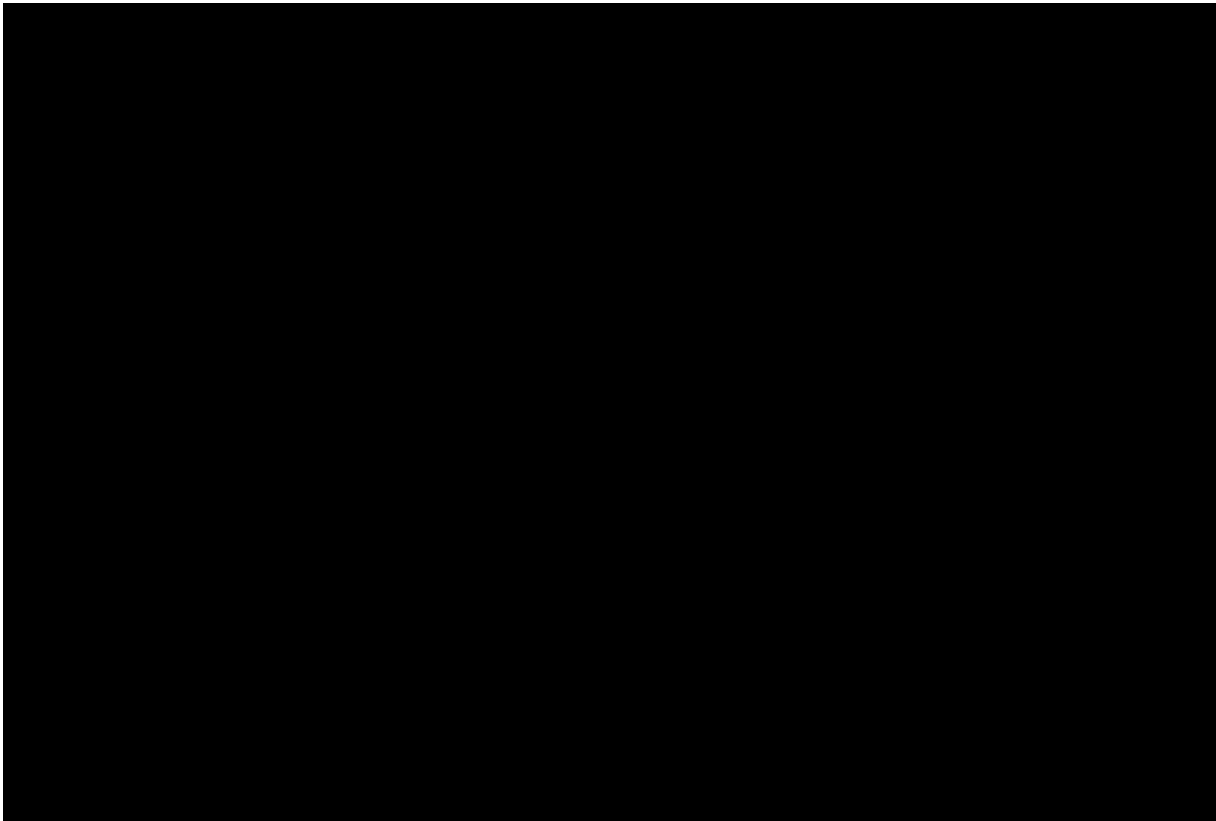

As noted in the tables above, the total capacity offered was 324.7 MW in total which was 16 times the amount requested. As a result, the response to the RFP can be classified as a robust response with many more project MWs submitted relative to nameplate capacity solicited. In addition, while solar PV PPA options dominated, there were other technologies and project structures submitted in various locations to allow for a competitive process.

### **Proposal Redactions**

The next step in the solicitation process that was implemented after submission of proposals was the redaction process of confidential information for each proposal. The intent of the redaction process for the ESI Administration team was to limit access to information about a proposal to specific project teams only to information necessary for each project team. For example, the EET team essentially required the pricing and operational information associated with a project to undertake its portion of the evaluation but should not require information associated with site control, permitting, financing or the like. Likewise, the VAT team did not require access to specific price information. In addition, one of the other objectives of the redaction process was to ensure Bidder names and Project names were not identified. Project team members, to the extent possible, would only have access to Bidder ID numbers and Proposal ID numbers.

The redaction process was designed as follows:

- ESI Administration team and the IM reviewed sections of the proposal and associated documents. The ESI Administration team redacted the information necessary for each project team;
- The ESI Administration team then placed the redacted proposal information in separate files for each project team;
- ESI then sent the files that had been redacted for each project team and for each proposal to the IM for review and approval. The IM reviewed each file and either approved the redactions or identified additional sections of the proposal which should also be considered for redaction or sections of the proposal that were redacted but which the IM felt should not be redacted. If the parties disagreed, the ESI team and IM discussed the comments and decided on the best approach for resolving any differences. For the ENO RFP, the ESI Administration team and IM were able to resolve all issues associated with the redaction process. For this solicitation, much of the information about proposal redaction was exchanged between the ESI team and IM via the PowerAdvocate Platform;
- Once agreement was reached, the ESI Administration team distributed the proposal information to each evaluation team based on the information required by each team for undertaking their evaluation for each proposal.

The IM's experience was that redaction process was undertaken in a careful and deliberate process to ensure information about the proposals was distributed as intended. The IM was not aware of any cases where information intended for specific project teams was improperly distributed to other teams who were not granted access.

### **Phase I Evaluation Process**

ESI began the Phase I evaluation process after the redactions and distribution of bidder information was completed. The initial step in Phase I was to undertake an initial threshold review to assess if the proposals were conforming to the requirements of the RFP. At this stage, ESI classified seven proposals as non-conforming. The primary reason for non-conformance was because these proposals did not include financial delivery to ENO's Load Zone (ESS.NOPLD) as required. The seven proposals were submitted by four bidders. One proposal was classified as non-conforming because it included a energy storage option with the solar PV project and another did not provide the accounting certification required. The proposal numbers that were initially classified as non-conforming were [REDACTED], [REDACTED], [REDACTED], [REDACTED], [REDACTED], [REDACTED], [REDACTED], meaning that eleven proposals were eligible for Phase I evaluation. The IM agreed with the classification of these proposals as non-conforming based on failure to accept the requirement for financial settlement in ENO's Load Zone for the reasons stated above. As the IM understands this requirement had been included in other Entergy RFPs. As a result, there were eleven proposals from seven bidders eligible for the Phase I evaluation.

---

<sup>10</sup> One Bidder clarified its proposal and indicated that it was offering an indicative basis allowance for financial settlement at the ENO Load Zone. As a result, this proposal was reinstated in the evaluation process.



On November 1, 2016, ESI provided an Executive Update to ENO on the proposals received and proposals identified as non-conforming during the initial stages of the Phase I process. ENO agreed with the assessment and recommendations and accepted the recommendation of SPO to eliminate the non-conforming proposals.

In early November, ESI began the process of submitting clarification questions to remaining Bidders regarding aspects of their proposals based on evaluation team reviews. Clarification letters were sent to all remaining proposals. In late November, [REDACTED] informed ESI that it was withdrawing its proposal [REDACTED] but did not provide a definitive reason. As a result, ten proposals were subject to the evaluation.

On December 13, 2016, the IM met with the evaluation teams at ESI's offices to review the evaluation results prepared by each team. The teams evaluated ten proposals in Phase 1. All proposals evaluated were based on solar PV technology, were located in Louisiana, and committed to financial delivery to ENO Load, as required. The total capacity of the proposals evaluated was 184.7 MW. This included 8 PPAs and two acquisition options.

The EET team presented its evaluation results in the form of both proposal cost (\$/MWh real levelized in 2017 dollars) and on a Net Benefits basis (2017\$/kW-year real levelized).<sup>11</sup> The Net Benefits for all the PPA proposals were positive (i.e. Energy Revenue + Capacity Revenue for each proposal minus Energy Payments), ranging from [REDACTED]. Five of the eight PPAs were closely bunched between [REDACTED]. Both acquisition proposals had negative Net Benefits, meaning that the costs exceeded the benefits for these projects.

The VAT team also presented its results during the meeting. In the initial review, the VAT relied on the Viability Self-Assessment provided by the bidders as well as initial proposal review. The VAT team classified 2 proposals [REDACTED] [REDACTED] as high risk, 5 proposals [REDACTED] as medium risk, and 3 proposals [REDACTED] as low risk.

The DAT team conducted its initial analysis and classified the deliverability risk to be low for all proposals evaluated.

The IM reviewed the evaluation results prior to the meeting with the ESI team. While the IM raised questions about the evaluation results, the questions were satisfactorily addressed by members of ESI's project team. After the discussions, the IM was generally in agreement with the quantitative and qualitative evaluation results for the Phase I process.

---

<sup>11</sup> For evaluation purposes, EET discounted both the Net Benefits and kW's for the purpose of calculating the \$/kW-year real levelized values.

<sup>12</sup> Proposal [REDACTED] was classified as a high risk based on its clarifying response that the 20 MW proposal offered was a portion of a larger 100 MW facility. The sale of the 20 MW was classified as contingent on the completion and execution of the remaining 80 MW. At the same time, this proposal had the highest Net Benefit value. After continued review and clarification Q&As with this bidder about its contingencies, On January 9, 2017 ESI sent a letter to this Bidder rejecting proposal [REDACTED].

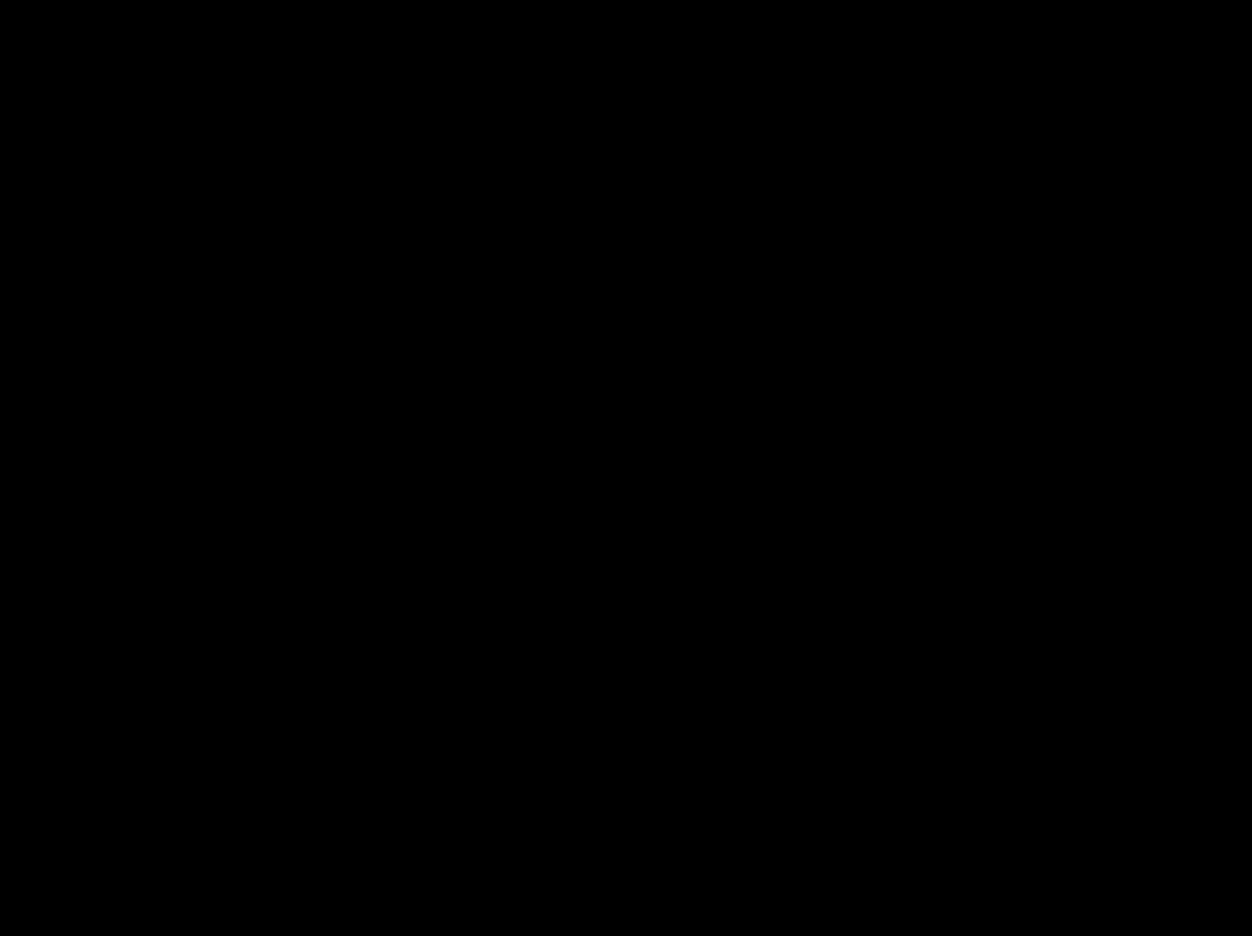

### **Clarification Questions for Bidders – Process Followed**

The clarification question portion of the solicitation process was an important component of the process as a means of confirming or clarifying information originally provided by the bidder. Once the evaluation teams began the evaluation of each of the proposals within the categories for which they were required to conduct their evaluations, the different teams identified clarification issues for each proposal to better understand, enhance the information base, or confirm information about each proposal. The project teams submitted their questions to the RFP Administrator who then prepared the questions in a consistent format for each Bidder and then crafted a letter for the Bidder. Prior to distributing the questions to the Bidders, the ESI Administrator sent the questions to the IM for review and comment. The IM could suggest revisions to the questions or “sign off” on the letter to the Bidders. Once approved by the IM, the letter with questions and any background information regarding requirements of the RFP were sent to the specific Bidders.

When Bidders sent in their responses, they were again reviewed and redacted if necessary prior to submitting the responses to each project team. The ESI Administrator sent the

redacted responses to the team's questions to the IM for review prior to distribution of the answers to the questions to the appropriate evaluation teams for review. This process was followed consistently for each proposal and Bidder, including the self-build proposal, during the period following submission of proposals.

### **Notification to Bidders**

On January 9, 2017, Entergy sent out notifications to bidders who were selected for the shortlist and those that would not be selected. For those accepted to the shortlist, ENO reminded the bidders that selection to the preliminary shortlist provides no assurance or indication that the proposal will be selected for the Primary or Secondary Selection List, that a definitive agreement will result from the process, or that ENO has accepted any contract terms.

ENO also requested that each Bidder with a proposal on the preliminary shortlist review their proposals and submit best and final offer for the shortlisted proposals. Bidders were informed that they are not permitted to increase the pricing offered in their proposals through the best and final offer pricing process. Bidders were requested to check the box in the Acknowledgment form whether they intend to provide a best and final offer or not. Bidders who propose to submit a best and final offer must complete the excel spreadsheet provided by ENO with its letter to bidders. The deadline provided to bidders for submission of the Acknowledgment was set as January 20, 2017.

### **Best and Final Pricing**

Of the eight eligible proposals, bidders for three proposals (i.e. two PPAs and one Acquisition option) submitted a best and final offer. The others elected not to revise their pricing.

### **Clarification Questions**

ENO continued the process of asking shortlisted bidders additional clarification questions if warranted. All bidders were requested to provide their expected Annual Guaranteed Energy Quantity at two probability levels – P50 and greater than or equal to P90. Other questions focused on specific risk aspects associated with each remaining project. ENO continued to ask clarification questions close to the proposed selection date of April 25, 2017.

### **Meeting With ENO Team to Discuss Evaluation Results**

The IM was presented with the results compiled by the evaluation teams in late February, 2017 and held meetings with each of the teams to review and critique the results.

The economic evaluation results identified one proposal [REDACTED] as ranking first in two of the three metrics evaluated for calculating Net Benefits (i.e. Net Benefit - Levelized \$/kW-year, in \$2017; Net Benefit - NPV – 2017 Million\$) and second in the other metric

(Net Benefit - Levelized \$/MWh, in 2017\$). The project enjoyed a [REDACTED] advantage (on a NPV – 2017 million\$) over proposal [REDACTED].<sup>13</sup> ESI also conducted a sensitivity case based on a low gas price, no CO2 price scenario and proposal [REDACTED] was still the highest ranked option. All PPA bids had a positive Net Benefit, with the top four options closely ranked. The two acquisition options, both of which are located in New Orleans, had negative economic benefit values, meaning their costs (as bid) exceeded their benefits (i.e. energy revenue and capacity revenue).

The Viability Assessment Team (VAT) also provided its assessment of the shortlisted proposals. The VAT noted that each proposal was evaluated and the key attributes scored on the following scale:

- 1 – (incomplete or deficient)
- 4 - (Adequate with some concerns)
- 7 - (Adequate and Above Average)
- 10 - (Fully Functional and Flexible)

In addition, the VAT has created a detailed evaluation matrix that included the basis for awarding the points listed above for the various criteria included. For example, this matrix essentially identified the basis for awarding 1, 4, 7, or 10 points to each proposal for each of the evaluation criteria listed in Table 6 below. The matrix served as the documentation on which all proposals were scored and ranked from a viability perspective. The IM found the evaluation matrix to be thorough and detailed with regard to the parameters for scoring and ranking proposals.

The scoring for each proposal was based on criteria for each attribute defined prior to receipt of proposals. Each proposal was also evaluated for commercial risk and categorized as Low, Medium, or High-risk proposals based on qualitative risks such as exceptions to the term sheet, experience with Bidder, or other commercial aspects encountered during the evaluation.

The VAT team concluded that multiple proposals require additional due diligence around environmental aspects but that no proposals were identified as high risk commercially, although some would require mitigation.

The VAT Team identified three proposals [REDACTED] as having low risk in the proposal viability assessment (i.e. Viable/Limited Mitigation) and the commercial risk categories. The remaining proposals [REDACTED] were classified as low risk in the Proposal Viability category and medium risk in the commercial risk category.

The IM reviewed the scores provided in each category and had some questions with regard to the scores for a few of the proposals. In particular, the IM felt that several scores awarded to proposal [REDACTED] were optimistic. After all scores were compiled proposal [REDACTED] had the highest proposal viability score.

<sup>13</sup>ESI concluded that proposal [REDACTED] was more risky because its energy revenues were based on a bidder provided profile which was not guaranteed and may be a bit more optimistic.

A list of the evaluation criteria and weights applied in the VAT evaluation assessment are included in Table 6.

**Table 6: Viability Assessment Criteria**

<b>Developmental Resources</b>		
<b>Evaluation Criteria</b>	<i>Weight for Category</i>	<i>Weight for Criteria</i>
<b>Bidder Experience/Operations</b>	20%	
Utility Scale Development Experience		60%
Utility-Scale Ownership/O&M Experience		25%
Equipment Maintenance Program		15%
<b>Project Status</b>	35%	
Status of Engineering Analysis		5%
Status of EPC Contracting Process		5%
Status of Project Financing		5%
Quality of Cost Estimate		10%
Site Control/Easements/ROW		50%
Certainty of COD		25%
<b>Technology</b>	20%	
Commercial Installations (Panels/wind turbines)		15%
Commercial Installations (Inverters)		15%
Operational History (Panels/wind turbines)		15%
Operational History (Inverters)		15%
Critical Equipment Reliability (turbines, inverters, etc.)		30%
Resource Quality/Data Profile Quality		10%
<b>Environmental</b>	15%	
Status of Permits		10%
Land/Environmental/Compliance Issues		30%
Operating Restrictions/Potential Permitting Issues		60%
<b>Long Term Planning</b>	10%	
MISO/RTO Experience (Operator)		30%
Proximity to Load		40%
Expansion Potential (Acquisition Only)		15%
Suitability of Surroundings (Acquisition Only)		15%
<b>Total</b>	100%	

The Deliverability Assessment Team (DAT) also conducted a more thorough review of the shortlisted proposals. The DAT team concluded that the analysis results verify that the identified sites are sufficient to accommodate the proposed capacity of each project offered. In fact, DAT concluded that it is feasible that the host sites could accommodate 4 to 5 times the offered capacity.

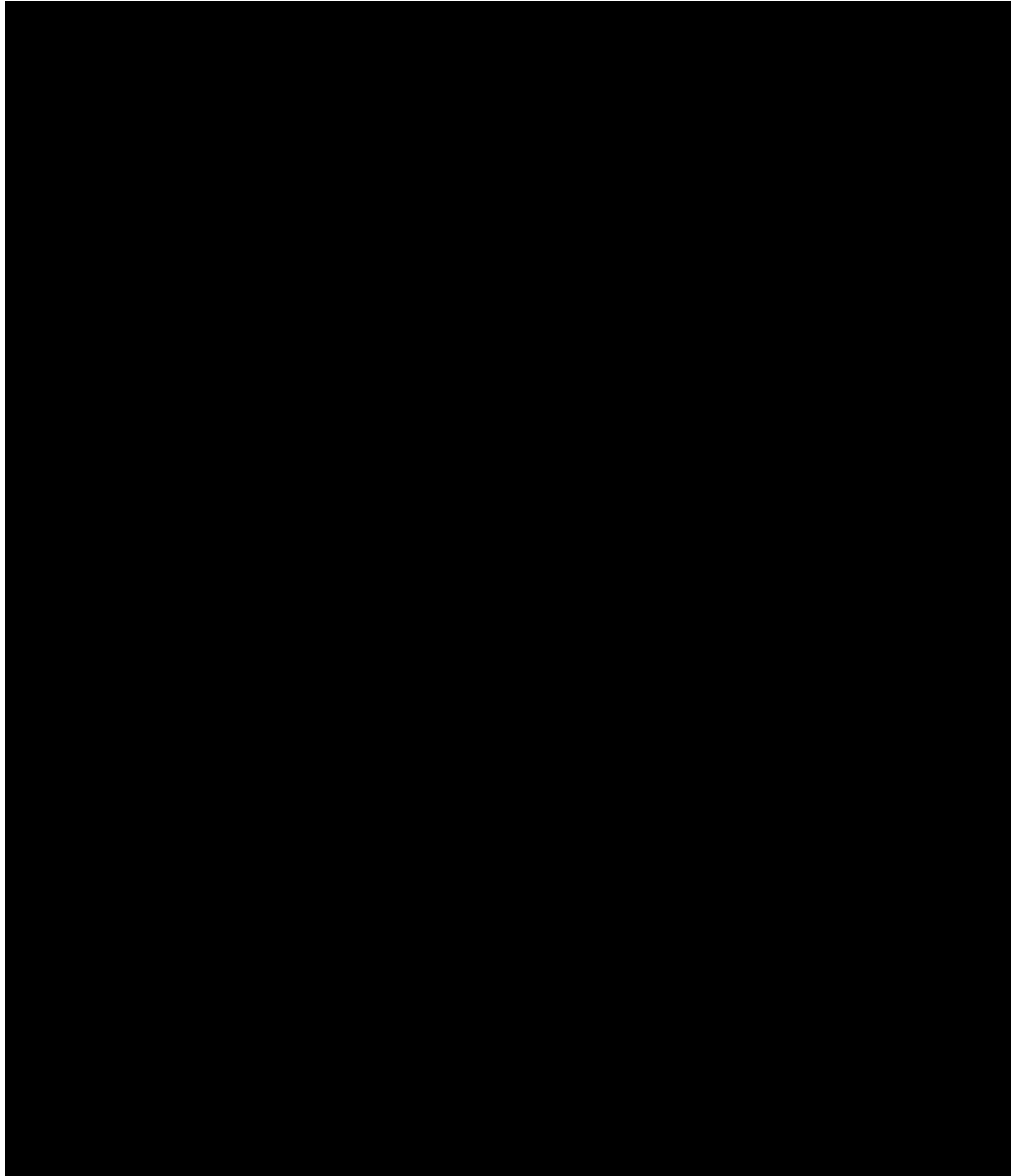



#### IV. Conclusions

Following are the conclusions reached by the IM regarding ENO's 2016 Renewable Resource RFP solicitation process:

- The 2016 ENO Renewable Resource RFP solicitation process was undertaken in a fair, equitable, and unbiased manner by ESI with the oversight of the IM. The solicitation process initiated by ESI is a consistent and equitable process designed to treat all proposals the same throughout the process. The IM found that ESI followed its protocols and objectives throughout the solicitation;
- The decision of ENO's Operating Committee to select three solar PV proposals totaling 44.7 MW was a reasonable decision and exceeded ENO's target requirements of 20 MW. In particular, the decision to select proposal [REDACTED] was an appropriate decision since this proposal provided the most value in terms of Net Benefits (Benefits minus Costs) and was deemed to be a viable project. The decision to select two acquisition options was reasonable given the need for generation in ENO's local area, although the cost of these proposals exceeded the benefits. ENO's support for these proposals was driven by the need for resources in the local ENO area. On a portfolio basis, the system benefits for all three projects was positive;
- ENO undertook a competitive procurement process with oversight by an Independent Monitor designed to ensure all Bidders were treated fairly and equitably. The process was designed based on previous ESI solicitation processes implemented in other states which have implemented formal competitive rules or guidelines;
- The ENO solicitation process contains a number of safe-guards<sup>14</sup> designed to ensure that all proposals were treated fairly and that there was no inherent

---

<sup>14</sup> The safeguards incorporated into the ENO RFP included: (1) separation of the self-build team from the evaluation team; (2) Application of a Code of Conduct and Affiliate Rules; (3) Designation of an RFP Administrator as a single point of contact with bidders; (4) submission and lock-down of the self-build several days before other proposals were submitted; (5) Requirement that all bidders, including the self-build, submit the same proposal information to ensure each proposal was consistently evaluated; (6) use of

advantage possible for the self-build option. The IM found that the implementation of the safe-guards instituted in the process exceeded industry standards. Furthermore, the safe-guards were diligently maintained throughout the solicitation process;

- The role of the IM in the ENO solicitation process was designed to be a very active role. Essentially, all communications between the ESI Administration Team, RFP Administrator, and all Bidders was coordinated through the IM;
- ESI treated the self-build option fairly and consistently relative to all other proposals. The self-build resource was required to provide the same information as all other proposals, was required to respond to follow-up questions, and was evaluated consistently relative to all other proposals;
- The RFP process was a reasonably transparent process, providing a reasonable level of information about the requirements for bidding, the products requested, the evaluation methods and methodology, the evaluation process, bid evaluation criteria, information required of the bidder, requirements of the bidder for submitting its proposal, the schedule for undertaking the process, and risk parameters of the Company as identified in the RFP and related contracts. In conjunction with the role of the IM throughout the process, in our view the transparency of the process is consistent with, and in some cases exceeds, industry standards for other competitive bidding processes;
- The bidder outreach and communication activities implemented by ESI were designed to encourage market participation by informing a large number of potential participants about the RFP. ESI maintains a large database of potential suppliers, power marketers and others and informed those entities of the development and issuance of the RFP. ESI also publicized the RFP via industry trade publications that regularly include reference to RFPs. Furthermore, throughout the process, bidders were informed about the solicitation through bidder and technical conferences and Notifications posted to ENO's website for the RFP;
- The response to the RFP was robust with over 16 times the amount of nameplate capacity proposed relative to the amount requested;
- All bidders were treated the same and provided access to the same information, including both third-party bidders and the self-build team. The ESI management team was very effective in providing consistent information to all bidders throughout the process, and for ensuring all proposals provided consistent information through the Q&A process with Bidders after proposals were submitted;

---

bidder, proposal and project ID numbers to eliminate any potential bias in the evaluation; (7) blinding of bid information and redaction of bidder names of other non-pertinent information when distributing information to the bid evaluation teams; and (8) inclusion of an active role for the Independent Monitor.



- The proposal evaluation models and methodologies were appropriate and reasonable for the cost and risk analysis undertaken by ESI;
- Merrimack Energy concluded that the models and methodologies used were sufficiently detailed and comprehensive, accurately accounting for all costs associated with the evaluation;
- ENO's two-stage evaluation process was effective in differentiating the proposals based on economic value and project viability;
- The level of documentation supporting the resource evaluation and selection process was very detailed. The Company provided the detailed back-up documentation to the IM during the evaluation process;
- ESI followed the established process for the 2016 ENO Renewable Resources RFP throughout the competitive solicitation. This included strict application of the threshold requirements, a detailed price and non-price assessment, follow-up questions to bidders to ensure consistent information was provided, and documentation of the decisions in the process. In essence, ESI's process proved to be a disciplined and detailed bidding process;
- ENO's solicitation was designed as a nine-month process from issuance of the RFP through final selection. The IM did not find this schedule to be unreasonable and it was generally consistent with the timeframe required for conducting such a thorough two-stage evaluation and selection process. The due diligence process undertaken by ENO, which included asking follow-up information requests of bidders as well as seeking clarification of information provided by bidders was designed to ensure all bids were on a level playing field and to identify any project viability and risk issues with the project prior to selection and the beginning of negotiations. While this due diligence process may take additional time to complete, it was not only fair to bidders but was expected that such efforts would result in the selection of viable projects.



***2016 Request For Proposals  
For  
Long-Term Renewable  
Generation Resources  
For  
Entergy New Orleans, Inc.***

Entergy Services, Inc.  
July 13, 2016

## TABLE OF CONTENTS

1.	GENERAL INFORMATION .....	5
1.1.	Introduction .....	5
1.2.	Entergy New Orleans, Inc. ....	5
1.3.	RFP Documents .....	7
1.4.	2016 ENOI Renewables RFP Website .....	8
1.5.	RFP Administrator .....	9
1.6.	Independent Monitor .....	9
1.7.	Eligible Participants .....	10
1.8.	Eligible Technology .....	10
1.9.	Eligible Resources .....	10
1.10.	RFP Scope Summary .....	11
2.	RFP OVERVIEW .....	13
2.1.	RFP Purpose .....	13
2.2.	Products Solicited and Select Contract Terms/Information .....	13
2.2.1.	Overview .....	13
2.2.2.	PPA Specifics .....	15
2.2.3.	Acquisitions .....	17
2.3.	RFP Proposal Requirements .....	18
2.3.1.	Economic Assessment Threshold Requirements .....	19
2.3.2.	Viability Assessment Threshold Requirements .....	19
2.3.3.	Accounting Assessment Threshold Requirements .....	20
2.3.4.	Credit Assessment Threshold Requirements .....	20
2.4.	Interconnection and Energy Deliverability Considerations .....	21
2.4.1.	Required Interconnection, Deliverability, and Transmission or Distribution Service .....	23
2.4.2.	Interconnection Service Applications .....	26
2.4.3.	Product Deliveries and Financial Settlement .....	27
2.4.4.	Scope of Responsibility .....	28
2.5.	Cost Recovery .....	29
2.6.	Design and Operating Considerations .....	30
3.	SELF-BUILD OPTION .....	30

4.	RFP SCHEDULE .....	31
	<b>4.1. Schedule</b> .....	<b>31</b>
	<b>4.2. Modifications of RFP Schedule</b> .....	<b>32</b>
5.	RFP MILESTONES AND PROCESSES: .....	32
	RFP ISSUANCE THROUGH PROPOSAL SUBMISSION .....	32
	<b>5.1. Bidders Conference</b> .....	<b>32</b>
	<b>5.2. Bidder Registration</b> .....	<b>32</b>
	<b>5.3. Proposal Submission</b> .....	<b>34</b>
	<b>5.4. RFP Hotline</b> .....	<b>35</b>
6.	RFP MILESTONES AND PROCESSES: .....	35
	PROPOSAL EVALUATION THROUGH CONTRACT NEGOTIATION .....	35
	<b>6.1. Overview and Assessments</b> .....	<b>35</b>
	<b>6.1.1. Threshold Requirements Assessments</b> .....	<b>37</b>
	<b>6.1.2. Economic Assessments</b> .....	<b>38</b>
	<b>6.1.3. Viability Assessments</b> .....	<b>39</b>
	<b>6.1.4. Accounting Assessments</b> .....	<b>40</b>
	<b>6.1.5. Credit/Collateral Assessments</b> .....	<b>42</b>
	<b>6.1.6. Resource Selection</b> .....	<b>42</b>
	<b>6.2. Notification of Evaluation Results; Commercial Negotiations</b> .....	<b>42</b>
7.	MISCELLANEOUS RFP MATTERS .....	43
	<b>7.1. Authorized Bidder Communications Channels</b> .....	<b>43</b>
	<b>7.2. Posting Questions</b> .....	<b>43</b>
	<b>7.3. Questions Involving Confidential Information</b> .....	<b>44</b>
	<b>7.4. Contact with MISO; Distribution-Related Communications</b> .....	<b>45</b>
	<b>7.5. Confidentiality Procedures for Bidder Registration and Proposal Submission Information</b> .....	<b>45</b>
	<b>7.6. Affiliate Rules and Codes of Conduct</b> .....	<b>46</b>
	<b>7.7. Multi-Person Bids</b> .....	<b>46</b>

## APPENDICES

<b>Appendices</b>	<b>Title</b>
Appendix A	Glossary
Appendices B-1 and B-2	Commercial Term Sheets for PPAs and Asset Acquisitions
Appendices C-1 and C-2	Preliminary Due Diligence for Developmental Resources and Existing Resources
Appendix D	Minimum Requirements for Developmental Resources
Appendix E	Reservation of Rights
Appendix F	Credit/Collateral Requirements
Appendix G	Process for Protection of Proposal Information
Appendix H	Form Distribution Interconnection Process Documentation

## 2016 ENOI REQUEST FOR PROPOSALS FOR LONG-TERM RENEWABLE GENERATION RESOURCES

### 1. GENERAL INFORMATION

#### 1.1. Introduction

Entergy Services, Inc. (“**ESI**”), acting as agent for Entergy New Orleans, Inc. (“**ENOI**”), hereby issues this 2016 Request for Proposals for Long-Term Renewable Generation Resources for Entergy New Orleans, Inc. (including all appendices, this “**RFP**”).

This RFP seeks up to 20 MW of energy, Environmental Attributes, Capacity, capacity-related benefits, and Other Electric Products from eligible renewable resources for deliveries starting as early as June 1, 2018, and as late as June 1, 2020, on the terms set forth herein, to help ENOI meet its integrated resource planning objectives, including, without limitation, increased depth and diversity of its generation resource portfolio. ESI intends to market-test a self-build alternative as part of the RFP (“**Self-Build Option**”). Section 2.6 and Section 3 below include additional information on the Self-Build Option.

A summary of the scope of this RFP, including the Products solicited, is provided in Section 1.10 below.

#### 1.2. Entergy New Orleans, Inc.

Entergy New Orleans, Inc. is an electric and gas utility that serves Orleans Parish, Louisiana. The company provides electric service to approximately 194,000 customers (2015 peak load of 1,069 MWh) and natural gas service to approximately 105,000 customers. Purchases under any Definitive Agreement resulting from this RFP would be for the benefit of ENOI and its customers.

A map of ENOI’s service area follows:

The statements contained in this RFP are made subject to the Reservation of Rights set forth in Appendix E of this RFP and the terms and acknowledgements set forth in the Proposal Submission Agreement.

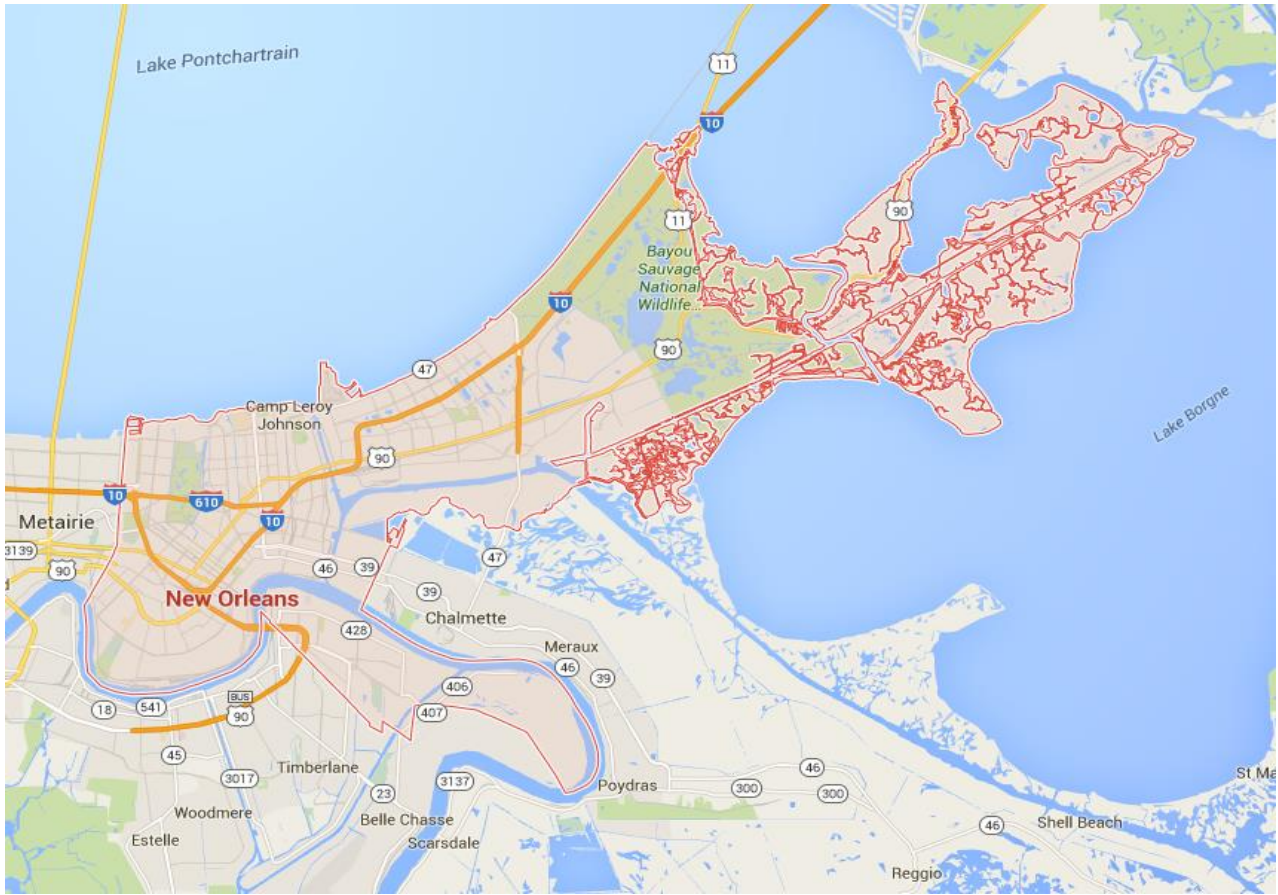

As discussed later in this Main Body, physical deliveries of power under a Definitive Agreement entered into pursuant to this RFP must be to MISO (resources directly interconnected to the MISO System) or the “MISO South” portion of the MISO System (LRZ 8, 9 and 10 collectively in the following map) (resources not directly interconnected to the MISO System).

The statements contained in this RFP are made subject to the Reservation of Rights set forth in Appendix E of this RFP and the terms and acknowledgements set forth in the Proposal Submission Agreement.

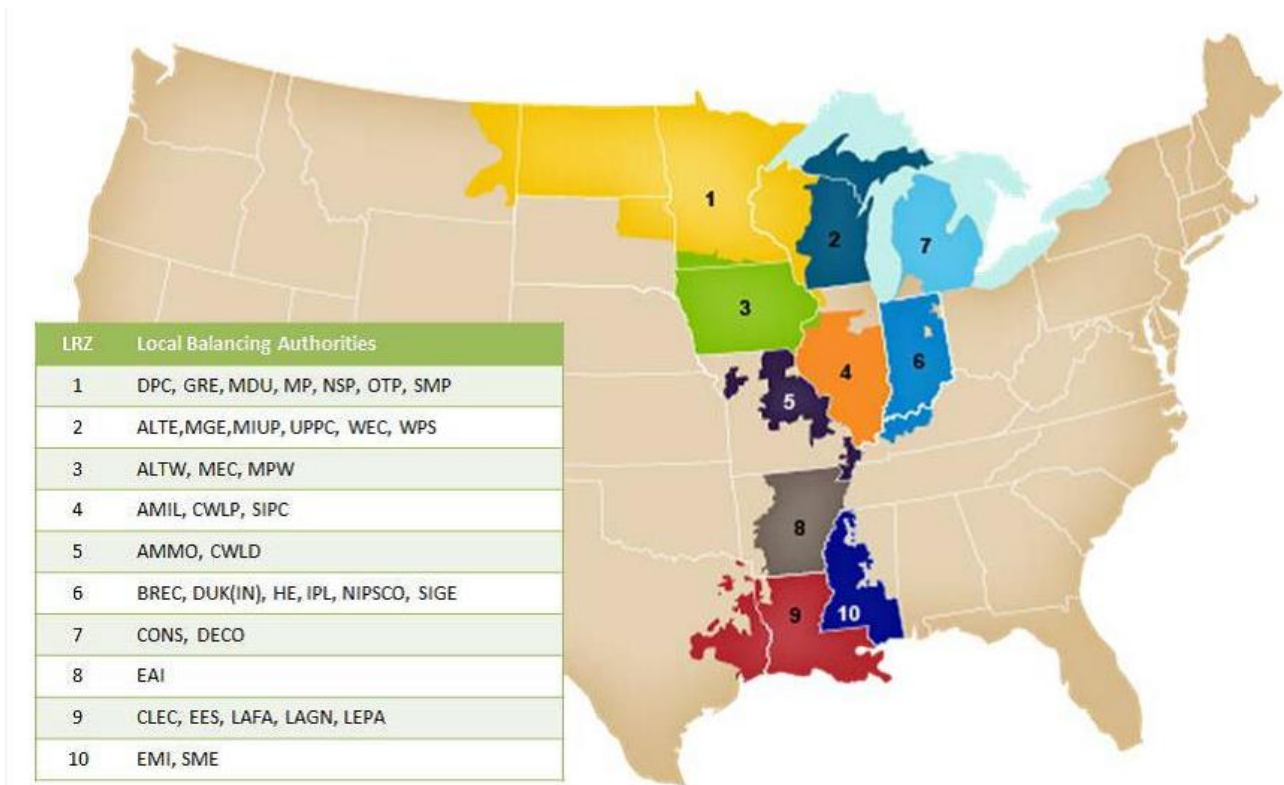

### 1.3. RFP Documents

This RFP consists of a Main Body and ten (10) appendices. Among other things, the Main Body (i) offers general information about this RFP, (ii) describes the purpose and drivers of this RFP, the Product types and certain Product features that ESI seeks from Bidders, and high-level considerations for Bidders, (iii) addresses the Self-Build Option being market-tested in this RFP, (iv) includes a milestone schedule for this RFP, (v) sets forth terms governing the registration of Bidders, the registration, preparation, and submission of proposals, and RFP-related communications with ESI and the IM, and (vi) provides an overview of the process for evaluating and selecting proposals submitted in response to this RFP.

Appendix A to this RFP is a glossary of certain capitalized terms used in this RFP. A capitalized term used but not defined in the Main Body will have the meaning ascribed to such term in Appendix A, except to the extent the context otherwise requires.

Appendices B-1 and B-2 are two term sheets (each, a “**Term Sheet**”), one for power purchase agreements (“**PPAs**”) and one for acquisitions of renewable generation assets. The Term Sheets summarize some of the key commercial terms that would apply to any PPA or asset acquisition Transaction arising out of this RFP, and are discussed in more detail in Section 2.2 below.

The statements contained in this RFP are made subject to the Reservation of Rights set forth in Appendix E of this RFP and the terms and acknowledgements set forth in the Proposal Submission Agreement.



Appendix C-1 contains questions and requests for information or material that Bidders will be required to answer or provide in connection with any proposal submitted into this RFP that is based on a Developmental Resource. Appendix C-2 contains questions and requests for information or material for any proposal submitted into this RFP that is based on an Existing Resource.

Appendix D describes the Minimum Requirements for Developmental Resources that Bidders must satisfy to submit a conforming proposal for a Developmental Resource into this RFP and addresses certain potential consequences of a failure to meet those requirements. Appendix D is not an exhaustive list of this RFP's requirements for conforming proposals for Developmental Resources; other terms of the RFP documents specify additional proposal requirements.

Appendix E contains an express reservation of ESI's rights in this RFP; warranty, liability, and contract acceptance disclaimers; terms addressing the disclosure of RFP-related information by ENOI, ESI, and Bidders in this RFP, Bidder's responsibility for RFP-related costs, and regulatory approvals; and Bidder's deemed acceptance of the rights and terms contained in Appendix E and ESI's reliance upon such acceptance.

Appendix F generally describes the process by which the Credit Evaluation Team will analyze Bidder's credit quality and Bidder's proposal(s) to assess potential credit risks and to establish collateral requirements for proposals selected for the Primary Selection List or the Secondary Selection List. In addition, Appendix F (along with Appendix D) addresses credit postings that may be required in the event a proposal based on a Developmental Resource does not satisfy the Minimum Requirements for Developmental Resources.

Appendix G provides information on the protocols ESI has established to ensure that (i) the RFP process will be impartial and objective, (ii) Bidders' commercially-sensitive information will be protected, (iii) all proposals will be treated in a consistent fashion, and (iv) no proposal from any particular Bidder, including the Self-Build Option, will receive undue preference.

Appendix H includes documents that describe the process for interconnecting to the ENOI electric distribution system and provide related material and information.

Bidders are responsible for familiarizing themselves with and being fully aware of the terms of this RFP, including the terms of each Appendix and the questions and answers and other information posted on the 2016 ENOI Renewables RFP Website.

#### **1.4. 2016 ENOI Renewables RFP Website**

The official website for this RFP is <https://spofossil.energy.com/ENTRFP/SEND/2016ENOIREnewableRFP/Index.htm> (the "**2016 ENOI Renewables RFP Website**"). This RFP and related material and information are posted on the 2016 ENOI Renewables RFP Website and available for review. The 2016 ENOI Renewables RFP Website will be updated from time to time with additional material and information concerning

The statements contained in this RFP are made subject to the Reservation of Rights set forth in Appendix E of this RFP and the terms and acknowledgements set forth in the Proposal Submission Agreement.

this RFP. Interested Persons are responsible for monitoring the 2016 ENOI Renewables RFP Website to ensure the timely receipt of information about this RFP.

### **1.5. RFP Administrator**

ESI has designated an “**RFP Administrator**” for this RFP. The RFP Administrator’s responsibilities include (i) acting as a liaison between the participants in this RFP and ESI on all RFP-related matters, (ii) ensuring that Bidder questions ESI receives are addressed in an appropriate manner, (iii) receiving, recording, and maintaining Bidder proposals, (iv) interacting with the IM and (v) managing other administrative matters relating to this RFP. The RFP Administrator is also a member of the “**RFP Administration Team.**” The full set of the RFP Administrator’s duties, and the role of the RFP Administration Team, are set forth in Appendix G.

The RFP Administrator for this RFP is Mr. Chris Stout. The contact information for the RFP Administrator is:

Mr. Chris Stout  
RFP Administrator  
Entergy Services, Inc.  
Parkwood II Building  
10055 Grogans Mill Road, Suite 300  
The Woodlands, TX 77380  
Email: [esirfp1@entergy.com](mailto:esirfp1@entergy.com)

As detailed in Section 7.1 below, all questions, requests, and other inquiries or communications from Bidders to ESI about this RFP must be directed in writing or via email to the RFP Administrator and the IM, except for communications made via the RFP Hotline (which often will be staffed by the RFP Administrator), as discussed in Section 5.4 below.

### **1.6. Independent Monitor**

ESI has retained Mr. Wayne Oliver of Merrimack Energy Group, Inc. to act as the Independent Monitor (“**IM**”) for this RFP. The role of the IM is defined in the IM’s “Scope of Work Activities,” which is posted on the 2016 ENOI Renewables RFP Website. In summary, the IM’s role will be to (i) monitor the design and implementation of the RFP solicitation, evaluation, selection, and contract negotiation processes to ensure their impartiality and objectivity and (ii) provide an objective, third-party perspective on ESI’s efforts to ensure that all proposals are treated consistently and without undue preference to any Bidder. Bidders wishing to communicate directly with Mr. Oliver may reach him by email at [waynejoliver@aol.com](mailto:waynejoliver@aol.com) or by phone at (781) 856-0007.

The statements contained in this RFP are made subject to the Reservation of Rights set forth in Appendix E of this RFP and the terms and acknowledgements set forth in the Proposal Submission Agreement.

## 1.7. Eligible Participants

ESI invites proposals from all potential suppliers capable of meeting the conditions and requirements identified in this RFP (the “**Eligible Participants**”), including other electric utilities, marketers, wholesale generators, electric cooperatives, independent power producers, and QFs. Proposals from QFs will not be provided any preference in this RFP solely by virtue of their QF status. Entergy Competitive Affiliates are ineligible to participate in this RFP. As discussed in more detail in Sections 2.6 and 3 below, ESI will consider and market-test a Self-Build Option as an alternative in this RFP. A “Bidder” may consist of more than one entity. For additional information concerning multi-party Bidders, please see Section 7.7 below. Otherwise Eligible Participants that do not comply with the terms, conditions, and requirements of this RFP may be determined by ESI, after consultation with the IM, to be ineligible to continue to participate in this RFP. To be an Eligible Participant, at the time it submits its proposal(s) in this RFP, Bidder must have the necessary licenses and other authorizations under applicable rules, regulations, and other laws to make such submissions, including any proposal involving the construction of a Developmental Resource.

## 1.8. Eligible Technology

The generation technologies permitted for proposals offered into this RFP are commercially-proven:

- hydrokinetic (limited to run-of-river hydroelectric) technology;
- solar photovoltaic (“**Solar PV**”) technology; and
- onshore wind technology (collectively, the “**RFP-Eligible Technologies**”).

Gas-fired generation, solid fuel, and nuclear technologies, demand-side management, offshore, energy efficiency, and energy storage technologies, and any other technology not listed in the above bullet points or not meeting the requirements of this RFP are not RFP-Eligible Technologies. Two or more forms of generation technologies (whether in a single facility or separate facilities) may not be combined to create an RFP-Eligible Technology.

## 1.9. Eligible Resources

This RFP is limited to resources that are RFP-Eligible Resources. “**RFP-Eligible Resources**” are generation resources that:

- (i) are Developmental Resources or Existing Resources:
  - (a) that will be or are directly interconnected to the MISO System and will physically deliver energy and other products contracted for by ENOI pursuant to this RFP to the electric interconnection point/CP Node for the resource specified by Bidder in the applicable proposal OR
  - (b) that will not be or are not directly interconnected to the MISO System and will physically deliver energy and other products contracted for by ENOI pursuant to

The statements contained in this RFP are made subject to the Reservation of Rights set forth in Appendix E of this RFP and the terms and acknowledgements set forth in the Proposal Submission Agreement.

- this RFP to the point in the MISO South portion of the MISO System specified by Bidder in the applicable proposal (either such delivery point, the “**Physical Delivery Point**”), AND for which, in either case,
- (c) financial settlement of such deliveries, if from a resource interconnected at a transmission voltage level (69 kV and higher), will be at the CP Node for the New Orleans Load Zone (EES.NOPLD) (the “**ENOI Load Node**”);
  - (ii) will utilize an RFP-Eligible Technology to make available and generate the products contracted to be provided to ENOI in any Definitive Agreement arising out of the underlying proposal;
  - (iii) will be a single integrated resource,<sup>1</sup> except for multiple Solar PV facilities interconnected at a distribution voltage level (less than 69 kV) (such facilities, collectively, an “**Aggregated Solar PV Resource**”); and
  - (iv) meet the other requirements for generating resources participating in this RFP.

### 1.10. RFP Scope Summary

The following table provides a high-level summary of key scoping items for this RFP.

Scope Item	RFP
<b>Products Solicited</b>	PPAs (all RFP-Eligible Technologies) and acquisitions (Solar PV only) (see Section 2.2, Appendices B-1 and B-2)
<b>Permitted Start Dates</b>	From June 1, 2018, to June 1, 2020 (see Section 2.2.2, Appendix D); ENOI prefers delivery start and termination dates that coincide with the start and termination of MISO planning periods
<b>RFP Capacity Target</b>	Up to 20 MW in the aggregate (see Sections 1.1, 2.1, 2.2)
<b>Proposal Capacity Requirements and Limitations</b>	<ul style="list-style-type: none"> <li>• Minimum contract Capacity for any resource except a Solar PV resource: 5 MW</li> <li>• Minimum contract Capacity for a Solar PV resource: 1 MW (AC)</li> <li>• Minimum capacity for any individual generating station that is part of an Aggregated Solar PV Resource: 100 kW (AC) (collectively, the “<b>Contract Capacity Minimums</b>”)</li> <li>• Maximum contract Capacity for any one resource: 20 MW</li> <li>• Maximum contract Capacity for an Aggregated Solar PV Resource: 5 MW (AC) (collectively, the “<b>Contract Capacity Maximums</b>”) (see Sections 2.1, 2.2)</li> </ul>

---

<sup>1</sup> Generation resources located at separate facility sites are considered multiple resources and may not be combined to form an RFP-Eligible Resource.

The statements contained in this RFP are made subject to the Reservation of Rights set forth in Appendix E of this RFP and the terms and acknowledgements set forth in the Proposal Submission Agreement.

<b>Eligible Technologies</b>	RFP-Eligible Technologies (see Section 1.8)
<b>Eligible Resources</b>	RFP-Eligible Resources, including Aggregated Solar PV resources, such as “rooftop Solar PV installations” (see Section 1.9); Developmental Resources must meet specified minimum requirements (see Appendix D)
<b>Resource Location</b>	<ul style="list-style-type: none"> <li>• Except for resources interconnected at a distribution voltage level, a location for resources sought in this RFP is not prescribed, but ENOI generally prefers, in order of preference, resources located in the ENOI Load Zone, then in LRZ 9, then in MISO South, then MISO, then outside of MISO</li> <li>• Resources interconnected at a distribution voltage level (including each individual generating station forming part of an Aggregated Solar PV Resource) must be located within specified portions of the ENOI Load Zone</li> <li>• Solar PV resources offered in an acquisition proposal must be located in the ENOI Load Zone (see Sections 1.2, 2.3, 2.4)</li> </ul>
<b>Interconnection Size Requirements</b>	<ul style="list-style-type: none"> <li>• Transmission Voltage Interconnections: 1 MW to 20 MW</li> <li>• Distribution Voltage Interconnections: 100 kW to 10 MW (see Section 2.4, Appendix D)</li> </ul>
<b>Physical Deliveries (PPAs)</b>	<ul style="list-style-type: none"> <li>• Products contracted for purchase from resources not directly interconnected to the MISO System must be physically delivered to MISO South</li> <li>• Products contracted for purchase from resources directly interconnected to the MISO System must be physically delivered to the electric interconnection point/CP Node for the resource within MISO (see Sections 1.9, 2.4)</li> </ul>
<b>Financial Settlement (PPAs)</b>	ENOI purchases from resources interconnected at a transmission voltage level will be financially settled at the ENOI Load Node and Seller will be responsible for any basis differential and all related costs between the applicable product price at the Physical Delivery Point and the product price at the ENOI Load Node. ENOI purchases from resources interconnected at a distribution voltage level are expected to be financially settled at the Physical Delivery Point (see Sections 1.9, 2.4.3)
<b>Delivery Term for PPAs</b>	Minimum: 10 years Maximum: 20 years (see Sections 2.2.2, 2.3.2)
<b>Self-Build</b>	A developmental Aggregated Solar PV Resource of up to 5 MW (AC) that would be sited entirely within permitted locations in the ENOI Load Zone (see Sections 2.6, 3)

The statements contained in this RFP are made subject to the Reservation of Rights set forth in Appendix E of this RFP and the terms and acknowledgements set forth in the Proposal Submission Agreement.

The preceding table omits several items that are or could be considered key scoping items. The scope of this RFP is established by terms set forth in the entirety of this RFP, including other sections of this Main Body and other RFP documents. The table is not, and should not be construed as, a substitute for the other provisions of this RFP.

## **2. RFP OVERVIEW**

### **2.1. RFP Purpose**

This RFP seeks up to a total of 20 MW of long-term renewable energy, Environmental Attributes, Capacity, capacity-related benefits, and Other Electric Products from RFP-Eligible Resources. The solicitation's primary objective is to request competitive proposals for renewable resources that could help ENOI meet its integrated resource planning needs and increase the depth and breadth of generation supply within its generation resource portfolio. Satisfying this objective may reduce long-term risk and provide other benefits to ENOI's customers. This RFP will also market-test a Self-Build Option.

Portions of this RFP, including, without limitation, the Contract Capacity Maximums, are incorporated as a means to promote diversity of resource supply, position ENOI to gain experience with different renewables technologies, limit ENOI's exposure to a particular counterparty, technology, contract, or resource, or a particular risk or set of risks, or achieve other commercial goals that ENOI deems appropriate. For the same reasons, ENOI may select proposals out of rank order. Bidders are reminded that, as of the issuance date of this RFP, ENOI is not bound by any Renewable Portfolio Standard (RPS) mandating the inclusion of any set or target amount of renewable generation resources in ENOI's resource plan.

Proposals offered into this RFP will be evaluated for their ability to achieve ENOI's integrated resource planning objectives and otherwise meet the needs of ENOI at the lowest reasonable cost, taking into account, without limitation, reliability, risk mitigation, the terms of this RFP, and other relevant factors. For more extensive treatment of other considerations in the development and evaluation of proposals, please refer to the remainder of this Section 2 and to Section 6 below. Without limiting its rights in Appendix E or elsewhere in this RFP, ENOI reserves the right to contract for more or less than the target amount stated in this RFP, not to contract for any particular RFP-Eligible Technology, not to contract for any energy and other products pursuant to this RFP, and to exceed any of the maximum contract Capacity limits identified in this RFP.

### **2.2. Products Solicited and Select Contract Terms/Information**

#### **2.2.1. Overview**

As noted, through this RFP, ENOI is seeking energy, Environmental Attributes, and related products from RFP-Eligible Resources that will reduce ENOI's future resource requirements and help satisfy its resource planning objectives. Proposals responsive to this RFP may be submitted for PPA

The statements contained in this RFP are made subject to the Reservation of Rights set forth in Appendix E of this RFP and the terms and acknowledgements set forth in the Proposal Submission Agreement.

Products. Acquisitions may be proposed as well, but only for Solar PV resources. Proposals for tolling agreements and other transaction forms are outside the scope of this RFP and will not be accepted. Proposals hereunder may not be contingent on actual interconnection costs, transmission costs, congestion costs, receipt of tax credits or other tax treatment, or any other Bidder's costs or credits, or the acceptance by a third party of a separate power sales or acquisition proposal based on the same resource (or power sales or acquisition agreement between a third party and Bidder or Seller).

The permitted transaction types for the RFP are described in the Term Sheets forming Appendix B. Each Term Sheet generally describes certain terms for a particular Product. The Term Sheet for PPAs is attached as Appendix B-1. Appendix B-2 contains the Term Sheet for asset acquisitions in this RFP. Select highlights of the Term Sheets are provided later in this Section 2.2.

Bidder is responsible for taking into consideration all terms and conditions included in the Term Sheet(s) corresponding to its proposal(s) when developing and preparing its proposal(s). ENOI expects that the terms and conditions summarized in the Term Sheet applicable to the proposed Transaction will be included in any Definitive Agreement executed for a proposal. Bidders are advised to carefully review the Term Sheet for the Product and Transaction for which Bidder intends to submit a proposal. Bidders should be guided by the descriptions and terms in the Term Sheets in formulating proposals. Subject to the remainder of this paragraph, in the event of any inconsistency between a provision in a Term Sheet and any other part of this RFP, including the Main Body, the Term Sheet will control.

From time to time, ESI may clarify, elaborate upon, adjust the terms or intent of, or provide relevant information concerning provisions of this RFP in response to questions from interested Persons, developments that may affect or require attention in this RFP, ESI perceptions or concerns that terms in this RFP may be incomplete, inaccurate, ambiguous, or misinterpreted or fail to adequately address risks, rights, or obligations, or for other reasons. Bidders should review ESI's responses to questions submitted in this RFP and its other postings on the 2016 ENOI Renewables RFP Website to ensure that they have the most current and accurate information concerning this RFP, including the Term Sheets.

Bidders not wishing to agree to a term set forth or described in the applicable Term Sheet must identify the specific term to which Bidder takes exception and provide a reasonably complete and detailed explanation of Bidder's position in the "**Special Considerations**" section of its proposal. Special Considerations will be taken into account in the evaluation of proposals. Special Considerations in which Bidder (i) reserves wholesale rights to make comments on terms or conditions included in a Definitive Agreement, (ii) makes widespread, wholesale, or fundamental changes to material terms or conditions set forth in the applicable Term Sheet, (iii) conditions its proposal on the acceptance of material terms or conditions not accepted by ESI in the ordinary course of business or that would materially diminish the value of the resource to ENOI or the viability of the proposal, or (iv) takes actions the effect of which would be similar to those resulting from the actions described in clauses (i)-(iii) are not contemplated and may be grounds for elimination from

The statements contained in this RFP are made subject to the Reservation of Rights set forth in Appendix E of this RFP and the terms and acknowledgements set forth in the Proposal Submission Agreement.

consideration in this RFP. Notwithstanding anything in this RFP to the contrary, ESI's acceptance or selection of a proposal containing exceptions in the Special Considerations section of Bidder's proposal does not mean that ESI or ENOI agrees with the exceptions or will agree to or accept the exceptions (or variants of the exceptions) in any negotiation of a Definitive Agreement. ESI and ENOI reserve all rights in any negotiation involving the exceptions, including, without limitation, the right not to accept or agree to any of the exceptions (or any variant thereof), the right not to pay Bidder or Seller any incremental amount or consideration if ESI or ENOI does not accept or agree to any particular exception, and the right to terminate negotiations if Bidder or Seller requires Bidder or Seller to agree to any particular exception as a condition to continued discussions.

Several Persons provided comments on and proposed changes to the draft Term Sheets posted on the 2016 ENOI Renewables RFP Website on May 6, 2016. While ENOI appreciates the feedback on the draft Term Sheets, after careful consideration ENOI has opted not to incorporate many changes to the Term Sheets based on those comments and proposed changes. Bidders should note, however, that ENOI's decision does not preclude them from including Special Considerations in their proposals relating to the substance of such comments or proposed changes.

Each Bidder must have, at the time it submits its proposal(s) in this RFP, the licenses and other authorizations required under applicable rules, regulations, and other laws, including Louisiana R.S. 37:2150-2192, Section 319, to submit such proposal(s).

### **2.2.2. PPA Specifics**

In this RFP, the PPAs being sought are for the long-term purchase of unit contingent energy, Environmental Attributes, Capacity, capacity-related benefits, and Other Electric Products from an RFP-Eligible Resource and related services. Any purchase of energy made pursuant to a PPA arising out of this RFP will also include any and all Capacity, capacity-related benefits (such as Capacity Credits), Other Electric Products, and Environmental Attributes associated with such energy or Capacity, the proposed resource, or the Transaction. Bidders are encouraged to review the Term Sheet for PPAs for terms and conditions applicable to the products and services to be provided to and acquired by ENOI under the Definitive Agreement. ESI will consider proposals for "financial" PPA structures (such as a PPA providing for settlement with MISO for energy and ancillary service products via financial schedules submitted to MISO, as indicated in Appendix B-1).

ESI will accept for evaluation PPA proposals offering less than the entire Capacity of the generation resource (whether the resource is an Existing Resource or a Developmental Resource) and meeting the requirements for participation in this RFP. Any proposal for a PPA submitted into this RFP must be for a resource that has or will have interconnection, metering, generating, compliance, communications, permitting, and other attributes required or appropriate to support registration, operation, and offers, schedules, and settlements of products under the PPA in MISO and/or the applicable Balancing Authority, in accordance with applicable MISO or Balancing Authority requirements and laws, as a reliable intermittent independent generating resource, and the requirements of this RFP.

The statements contained in this RFP are made subject to the Reservation of Rights set forth in Appendix E of this RFP and the terms and acknowledgements set forth in the Proposal Submission Agreement.



PPA pricing will be based on an energy rate (expressed in \$/MWh), which will be either fixed for the entire Delivery Term or defined annually (expected to be as proposed by Bidder). The energy rate will be subject to temporary reductions if specified annual excess delivery thresholds have been reached.

A PPA proposal's pricing must reflect an "all-in" energy price (including all related fees and expenses) that ENOI would pay to Seller for all aspects related to, and products associated with, the provision, generation, and delivery to ENOI of energy, Environmental Attributes, Capacity, capacity-related benefits, and Other Electric Products and Seller's performance and risks under the PPA. Pricing should take into account any tax credits and tax benefits associated with the resource.

The following highlights a few basic commercial terms for PPAs sought by this RFP:

- *Delivery Requirements* - PPAs will include guaranteed annual energy delivery minimums entitling ENOI to liquidated damages if the minimums are not met and to terminate the PPA for specified failures to meet energy delivery minimums over any two (2) consecutive contract years or any three (3) contract years (whether or not consecutive). See Appendix B-1 for additional details. Physical deliveries and financial settlements will be as described in Sections 1.9 above and 2.4.3 below.
- *Delivery Term* – The Delivery Term for PPAs will be a minimum of ten (10) and a maximum of twenty (20) consecutive years. The Delivery Term is expected to be based upon the Delivery Term specified in the proposal giving rise to the PPA. If the Delivery Term would expire on a date that is not the end of the planning period recognized by the applicable Balancing Authority (May 31 under the current MISO Rules), ENOI will have an option, exercisable at no cost to ENOI, to extend the Delivery Term on the same commercial terms so that it terminates at the end of such planning period.
- *Delivery Term Commencement* - The guaranteed Delivery Term commencement date for any PPA arising out of this RFP must be a date ranging from June 1, 2018, to June 1, 2020. Buyer prefers that the Delivery Term start at the beginning of the planning period recognized by the applicable Balancing Authority (June 1 under the current MISO Rules). The guaranteed Delivery Term commencement date is expected to be based upon the guaranteed Delivery Term commencement date specified in the proposal giving rise to such PPA. For proposals predicated on a Developmental Resource, Bidder may be subject to delay damages (which may include damages for Buyer's loss of Capacity Credits) and "buy-down" damages and a potential re-sizing of the PPA and/or, for extended delays, contract termination and a termination payment if the actual commercial operation date is later than the guaranteed commercial operation date.
- *Contract Capacity* - The amount of contract Capacity in any PPA is expected to be based upon the contract Capacity specified in the proposal giving rise to the PPA. The amount

The statements contained in this RFP are made subject to the Reservation of Rights set forth in Appendix E of this RFP and the terms and acknowledgements set forth in the Proposal Submission Agreement.

of generating Capacity allocated to Buyer under any PPA will be no less than the Contract Capacity Minimum and no more than the Contract Capacity Maximum for the applicable resource (as provided in Section 1.10 above).

- *Conditions Precedent* - Any PPA arising out of this RFP will include numerous conditions precedent to commencement of the Delivery Term, including a condition for the benefit of ENOI that ENOI has obtained regulatory approvals and regulatory treatment on terms and conditions satisfactory to ENOI in its sole and absolute discretion.
- *Delivery/Receipt Commitment* – Subject to certain conditions to be set forth in a Definitive Agreement, including, without limitation, ENOI’s right to curtail energy and force majeure, Seller will be required to deliver to ENOI, and ENOI will be required to purchase from Seller, all energy from the contract Capacity delivered to the Physical Delivery Point. As part of its delivery commitment, Seller will waive any and all QF put rights with respect to the Capacity contracted to Buyer under the PPA.
- *Liability Transfer* – ESI will not accept the risk that any long-term liability will or may be recognized on the books of ENOI (or any of its Affiliates) in connection with any PPA entered into pursuant to this RFP, whether the long-term liability is due to lease accounting, the accounting for a variable interest entity or derivatives, or any other applicable accounting standard or requirement.

The foregoing is not intended, and should not be construed, as an exhaustive listing of important commercial terms for any PPA arising out of this RFP. Please refer to Appendix B-1 for a more detailed summary of select PPA terms and to Sections 1.7 through 1.10 above, Sections 2.3 through 2.6 below, and Appendix D for certain other commercial provisions or considerations relevant to PPA Products.

### **2.2.3. Acquisitions**

Acquisition Products for Solar PV resources are being solicited in this RFP. This RFP is not seeking, and Bidders should not propose, Acquisition Products for any other resources. The purchase price must be expressed as a single fixed payment for the proposed acquisition and should exclude any investment tax credit or bonus depreciation value potentially transferrable with the resource unless ESI otherwise directs. Bidders will be required to identify any such potentially applicable investment tax credit or bonus depreciation value in its responses to diligence questions set forth in Appendix C-1 or Appendix C-2, as applicable. ENOI expects to capture and normalize the investment tax credit and bonus depreciation over the asset life in accordance with IRS regulations. If Bidder desires to propose an alternate approach for the treatment and realization of the investment tax credit and bonus depreciation, Bidder may include (as a Special Consideration) an alternate fixed payment amount and a detailed explanation of the accounting, tax, and legal basis for such structure. The amount of Capacity to be obtained under any asset purchase agreement arising

The statements contained in this RFP are made subject to the Reservation of Rights set forth in Appendix E of this RFP and the terms and acknowledgements set forth in the Proposal Submission Agreement.

out of this RFP must be no less than the Contract Capacity Minimum and no more than the Contract Capacity Maximum for the applicable resource (see Section 1.10 above).

The following highlights a few basic commercial terms that apply to any acquisition proposed in the RFP:

- *Closing* - The closing of the acquisition will be scheduled to occur no earlier than June 1, 2018 and no later than June 1, 2020. For Developmental Resource proposals, Seller may be subject to delay damages (which may include damages for Buyer's loss of Capacity Credits) and "buy-down" damages and, for extended delays, contract termination and termination damages if the actual commercial operation date is later than the guaranteed commercial operation date (expected to be as specified by Bidder in its proposal).
- *Purchased Assets* - The assets to be sold must include the entire Facility. Proposals for an acquisition of a resource that would be jointly owned after the closing or would reasonably require a joint ownership and operation agreement or similar agreement will not be considered.
- *Durability of Authorizations* - Seller will retain the risk that the acquisition under a Definitive Agreement is unable to close in the event that any FERC, HSR, or other required authorization becomes invalid or ineffective prior to the closing. Bidders are encouraged to consider this risk in the development of their acquisition proposals and include in their proposals acquisition structures or mechanisms that address and/or mitigate any identified risk. ESI's evaluations of acquisition proposals may assess the risk that a required authorization will not be obtained or will become invalid or ineffective prior to the closing of the proposed Transaction and may assess the effectiveness of proposed risk mitigation measures.

The foregoing is not, and should not be construed as, an exhaustive listing of important commercial terms for any asset purchase transaction arising out of this RFP. Please refer to Appendix B-2 for a broader-based summary of select contract terms for acquisition transactions and to Sections 1.7 through 1.10 above, Sections 2.3 through 2.6 below, and Section 3 below for certain other commercial provisions or considerations relevant to Acquisition Products.

### **2.3. RFP Proposal Requirements**

Subject to the other terms of this RFP, ESI will consider only proposals submitted in accordance with and meeting the requirements of Section 5 below. In addition to those proposal submission requirements, proposals under this RFP are required to satisfy, and will be reviewed early in the RFP evaluation process for compliance with, the prerequisites specified in this Section 2.3 (collectively, the "**Threshold Requirements**"). Any proposal not meeting the Threshold Requirements will be considered non-conforming and may be eliminated from further consideration in this RFP by ENOI, after consultation with the IM. The Threshold Requirements include the Economic Assessment Threshold Requirements, the Viability Assessment Threshold Requirements,

The statements contained in this RFP are made subject to the Reservation of Rights set forth in Appendix E of this RFP and the terms and acknowledgements set forth in the Proposal Submission Agreement.

the Accounting Assessment Threshold Requirements, and the Credit Assessment Threshold Requirements, each as described below.

### **2.3.1. Economic Assessment Threshold Requirements**

The following Threshold Requirements are the “**Economic Assessment Threshold Requirements**”:

- Pricing offered in a proposal must be energy-only (PPAs) or a single fixed payment (acquisitions) and be reasonably competitive, in ESI’s judgment, with market prices for PPAs or for acquisitions, as applicable, of long-term renewable resources and other proposals offered into the RFP based on the same type of RFP-Eligible Technology.

### **2.3.2. Viability Assessment Threshold Requirements**

The following Threshold Requirements are the “**Viability Assessment Threshold Requirements**”:

- The resource supporting Bidder’s proposal must be an RFP-Eligible Resource, and Bidder must provide evidence satisfactory to ESI demonstrating that the proposed resource is an RFP-Eligible Resource.
- Bidder must be an Eligible Participant.
- For Developmental Resources, Bidders must meet the applicable Minimum Requirements for Developmental Resources set forth in Appendix D and the requirements of Section 2.6 below. Without limiting ESI’s rights under Appendix D or E, ESI, in consultation with the IM, may allow variances from the Minimum Requirements for Developmental Resources.
- For Developmental Resources, the resource must be free of fatal design flaws and/or non-standard operational or permitting restrictions that would reasonably be expected to prevent it from meeting the requirements of this RFP, including, without limitation, Section 2.6 below and the applicable minimum requirements listed in Appendix D.
- For proposals offering a PPA Product into this RFP, the proposed Delivery Term must be no less than ten (10) consecutive years and no more than twenty (20) consecutive years and must be proposed to start no earlier than June 1, 2018, and no later than June 1, 2020. The Bidder-proposed closing date for an acquisition Product offered into this RFP must be no earlier than June 1, 2018, and no later than June 1, 2020.
- A proposal must offer at least the Contract Capacity Minimums and may not exceed the Contract Capacity Maximums applicable to the type of resource proposed. Bidders must not have offered combined Capacity, energy, and Other Electric Products from separate

The statements contained in this RFP are made subject to the Reservation of Rights set forth in Appendix E of this RFP and the terms and acknowledgements set forth in the Proposal Submission Agreement.

renewable generation facilities in any proposal other than a proposal based exclusively on an Aggregated Solar PV Resource.

- For Developmental Resources, Bidders offering a proposal must provide an hourly generation profile and explain how it was derived. The profile should be based upon data, to the extent available, for a period of two (2) or more recent years using established, reliable, and accurate data measurement equipment at or near the site of the proposed resource and/or a third-party assessment study. (Bidders should provide this information in the appropriate fields in the Proposal Submission Template posted on the 2016 ENOI Renewables RFP Website.) For Existing Resources, Bidders should provide the projections and historical data information required by Section 6.5 of Appendix C-2.
- Resources interconnecting at a distribution voltage level must be located within the ENOI Load Zone, must not require more than 10 MW of interconnection service, and must interconnect outside the shaded area shown in the map shown in Section 2.4 below.
- The proposed resource must be eligible to qualify as a Long-Term Network Resource (if interconnected at a transmission level) or a Load Modifying Resource (if interconnected at a distribution level) of ENOI under the MISO Tariff.
- The proposed resource must be capable of providing the offered amount of energy, Capacity, and Other Electric Products to ENOI at the Physical Delivery Point.
- For resources interconnected at a transmission level, Bidders must provide the interconnection, deliverability, and transmission service documentation for their proposals to the RFP Administrator or as part of their Proposal Packages in accordance with the applicable requirements of Sections 2.4.1 and 2.4.2 of this RFP. For resources interconnected at a distribution level, Bidders must provide the interconnection, deliverability, and distribution service documentation for their proposals as part of their Proposal Packages in accordance with the applicable requirements of Sections 2.4.1 and 2.4.2 of this RFP.

### **2.3.3. Accounting Assessment Threshold Requirements**

The following Threshold Requirements are the “**Accounting Assessment Threshold Requirements**”:

- Bidder must include in the Proposal Package the accounting certification required under, and prepared, executed, and submitted in accordance with the requirements of, Section 6.1.4 below.

### **2.3.4. Credit Assessment Threshold Requirements**

The following Threshold Requirements are the “**Credit Assessment Threshold Requirements**”:

The statements contained in this RFP are made subject to the Reservation of Rights set forth in Appendix E of this RFP and the terms and acknowledgements set forth in the Proposal Submission Agreement.

- Bidder must provide the most recent Published Credit Rating of Bidder or, if different from Bidder, Seller (from S&P and Moody's), to the extent such a rating exists.
- Bidder must provide the annual audited financial statements (and accompanying notes) for the past two (2) years and the current-year reviewed quarterly financial statements (and accompanying notes) of Bidder or, if different from Bidder, Seller.
- If Bidder proposes that a Person serve as a Credit Support Provider for Bidder's proposal, each of the two previous Threshold Requirements will apply to such Credit Support Provider. Bidder must extract and submit as separate documents by the Proposal Submission Deadline all financial data and information of Bidder, Credit Support Provider, or both (as applicable) that is consolidated with financial data or information of another Person and required under this Section 2.3.4.

Please see Section 6.1 below for additional information on the Threshold Requirements, including the evaluation of proposals for satisfaction of the requirements.

#### **2.4. Interconnection and Energy Deliverability Considerations**

This Section 2.4 identifies and addresses certain interconnection and deliverability issues or requirements that Bidders should consider as they prepare a proposal for this RFP. Bidders are encouraged to consider and perform due diligence on the interconnection and deliverability costs applicable to their proposals prior to proposal submission. ENOI generally prefers resources located within the ENOI Load Zone, but RFP-Eligible Resources located outside or inside the MISO System may be offered into this RFP. Aggregated Solar PV Resources, however, must be located entirely within the ENOI Load Zone.

Proposed resources located outside the ENOI Load Zone must electrically interconnect at a transmission voltage level. Except for Aggregated Solar PV Resources, which must interconnect at a distribution voltage level, and resources greater than 10 MW, which must interconnect at a transmission voltage level, resources proposed in this RFP that are located within the ENOI Load Zone may interconnect to the electric grid at either a transmission or a distribution level. Interconnection at a distribution level for resources participating in this RFP is allowed only within the ENOI Load Zone, but only outside the shaded area shown in the map below:

The statements contained in this RFP are made subject to the Reservation of Rights set forth in Appendix E of this RFP and the terms and acknowledgements set forth in the Proposal Submission Agreement.

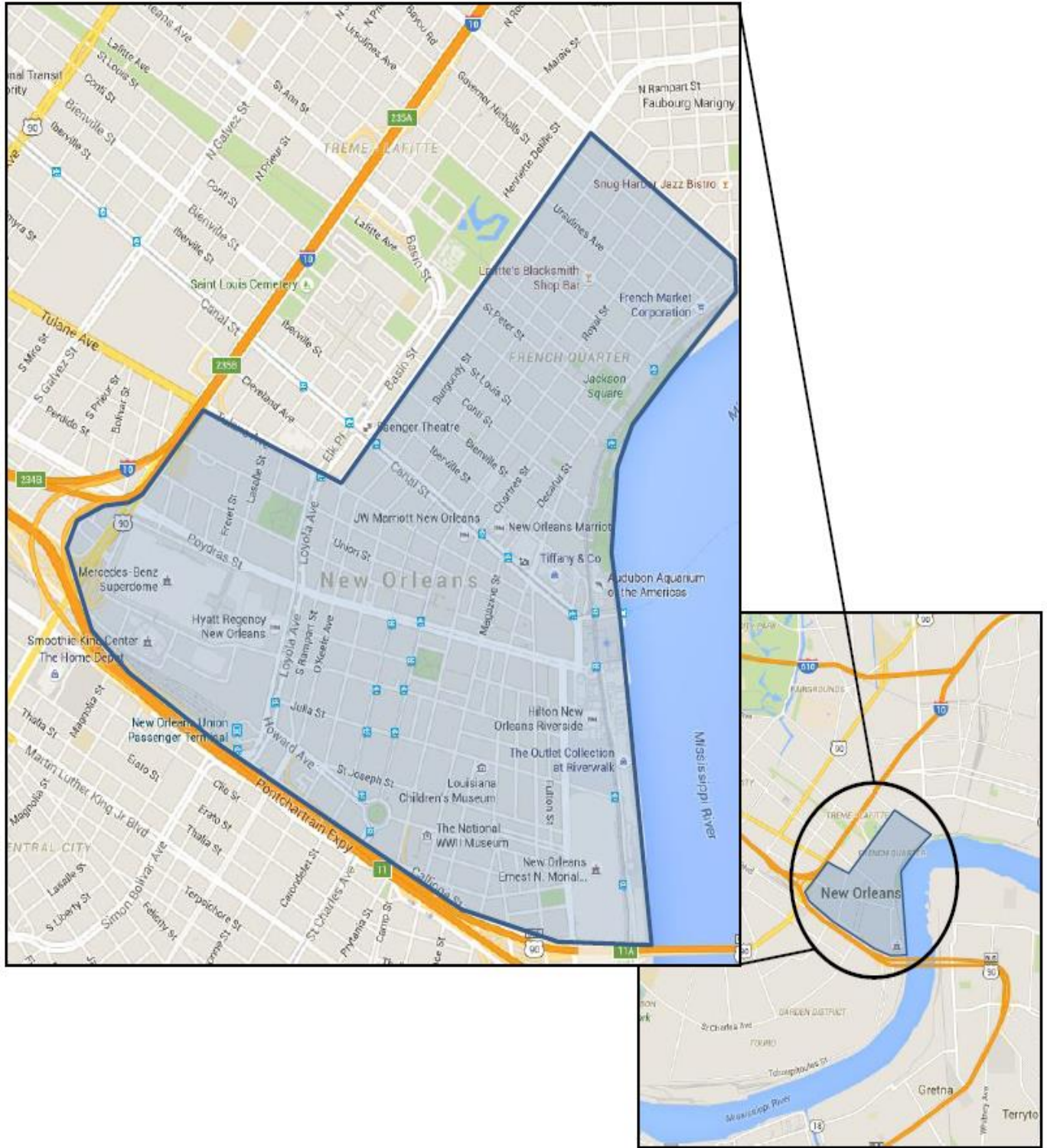

The statements contained in this RFP are made subject to the Reservation of Rights set forth in Appendix E of this RFP and the terms and acknowledgements set forth in the Proposal Submission Agreement.

Proposals for resources that interconnect to the electric grid “behind the meter” and proposals contemplating “net metering” billing arrangements will not be considered in this RFP. If Bidder proposes to interconnect the offered resource at a distribution interconnection level, the resource must be eligible to qualify as a Load Modifying Resource under the MISO Tariff. A Bidder may not propose an offered resource of less than one (1) MW that would interconnect at a transmission level. Bidders should follow the communications protocols set forth in the second paragraph of Section 7.4 below for communications involving distribution level service processes and requirements for resources that have been or may be offered in this RFP.

#### **2.4.1. Required Interconnection, Deliverability, and Transmission or Distribution Service**

Seller will be required, under the terms of the applicable Definitive Agreement, to have obtained for the proposed resource, prior to the commencement of the Delivery Term, interconnection, deliverability, and firm transmission or distribution service to the Physical Delivery Point.

##### Transmission-Level Resources

For Existing Resources that are, or Developmental Resources that will be, directly interconnected to the MISO transmission system, the Definitive Agreement will require Seller to have obtained ERIS and NRIS (or, in the event that either MISO changes its interconnection rules or service options such that ERIS or NRIS, or ERIS or NRIS as contemplated by this RFP, is no longer available or MISO is no longer an applicable Balancing Authority, the equivalent interconnection and deliverability/transmission service). The amount of ERIS that Seller will be required to have obtained is at least the amount of the Capacity of the Facility. The amount of NRIS that Seller will be required to have obtained is at least the Minimum Required NRIS Quantity. The “**Minimum Required NRIS Quantity**” is (i) for proposals offering the full amount of the Capacity of the resource, the quantity of NRIS that is sufficient to allow the resource to be eligible to receive, throughout the Delivery Term for PPA Products and at the time of Transaction closing for Acquisition Products, the maximum Capacity Credits a resource of its Capacity size can receive under the MISO Rules, and (ii) for proposals offering less than the full amount of the Capacity of the resource, the quantity of NRIS that can and will be allocated and prioritized such that the NRIS level associated with the resource’s Capacity under contract to Buyer cannot limit the amount of MISO Capacity Credits that Buyer would receive for any planning period during the Delivery Term. Accordingly, if a proposal is based on an Existing Resource that is directly interconnected to the MISO transmission system and does not have, or that MISO has not conditionally granted, at least the Minimum Required NRIS Quantity (an “**IS-Deficient Existing Resource**”), Bidder, Seller, or a third party acting on its or their behalf will be required to request from MISO, through a generator interconnection service application or other means required by or acceptable to MISO, at least the amount of NRIS necessary for the Existing Resource to obtain the Minimum Required NRIS Quantity.

The statements contained in this RFP are made subject to the Reservation of Rights set forth in Appendix E of this RFP and the terms and acknowledgements set forth in the Proposal Submission Agreement.



For Existing Resources that are not, or Developmental Resources that will not be, directly interconnected to the MISO transmission system (“**External Resources**”), the Definitive Agreement will require Seller to have obtained both interconnection service and firm deliverability/transmission service from the applicable resource to the Physical Delivery Point in amount(s) sufficient to enable Seller to deliver at least the maximum amount of contract energy that Seller may deliver to the Physical Delivery Point under the Definitive Agreement as proposed by Bidder or permitted under the Definitive Agreement (the “**Minimum Required External Interconnection and Deliverability Service**”).

For proposals based on a resource that has, or has been conditionally granted, at least the Minimum Required NRIS Quantity of NRIS or the Minimum Required External Interconnection and Deliverability Service, as applicable, Bidder, Seller, or a third party acting on its or their behalf will be required to maintain the Minimum Required NRIS Quantity or the Minimum Required External Interconnection and Deliverability Service, as applicable, for the resource or to take the actions required to preserve or satisfy the conditions set forth in the conditional grant.

For a resource proposing to deliver energy to the Physical Delivery Point at a transmission voltage level, ENOI expects to seek to qualify such resource selected from this RFP as a Long-Term Network Resource of ENOI in MISO for the Delivery Term (in the case of PPAs) or from and after the closing of Transaction (acquisitions). The Definitive Agreement will require Seller, subject to ENOI’s directions to the contrary, to take all actions necessary or advisable to cause the resource to be qualified and/or recognized in MISO for the Delivery Term or after the closing, as the case may be, as a Long-Term Network Resource of ENOI, with full network integration transmission service, and to cause ENOI to be eligible for and receive all transmission rights and entitlements associated with the contract Capacity of the resource, including, without limitation, auction revenue rights and financial transmission rights.

#### Distribution-Level Resources

For Developmental Resources proposed to interconnect to ENOI at a distribution voltage level, Bidders may, but are not required to, submit to ENOI a distribution-level interconnection service application (see Section 2.4.2 below) for the proposed resource at any time prior to the announcement of the selection of proposals to the Primary Selection List and/or the Secondary Selection List. If a Bidder’s proposal for a distribution-level resource is selected for negotiation of a Definitive Agreement, Bidder will be required to prepare, complete, and submit to ENOI, in accordance with the applicable application requirements, an interconnection service application within a time that supports the schedule for execution, receipt of regulatory approval, and commencement of the Delivery Term of or the Transaction closing under the Definitive Agreement. The required distribution-level interconnection service application will vary depending on the size of the proposed resource. The amount of distribution-level interconnection service sought for the resource must be at least the maximum amount of energy that can be provided to ENOI at any time under the applicable Definitive Agreement. To assist ESI with the evaluation of proposals for distribution-level resources in this RFP, Bidders offering such resources will be required to supply

The statements contained in this RFP are made subject to the Reservation of Rights set forth in Appendix E of this RFP and the terms and acknowledgements set forth in the Proposal Submission Agreement.

distribution interconnection-related information in their responses to certain requests for information propounded in Appendix C-1 or Appendix C-2 as part of their Package Proposal.

The previous paragraph notwithstanding, ESI may require that Bidder (or its designee) submit to ENOI a distribution-level interconnection service application for the proposed resource prior to the announcement of proposal selections if the VAT, the RFP Evaluation Team, or ESI has determined that, based on the information then actually known by it, (i) the evaluation or selection of proposals in the RFP or (ii) the schedule for execution or regulatory approvals of the Definitive Agreement or the schedule for the Delivery Term commencement date or the closing date under the proposed Transaction may be adversely affected if the application is not submitted as directed by ESI. ESI may also require that Bidder provide to the RFP Administrator complete and accurate copies of any interconnection application submitted to ENOI pursuant to ESI's direction and other documents related to such application.

Proposed resources requiring distribution-level service must interconnect, in accordance with the distribution interconnection procedures and requirements for such resources established from time to time by ENOI, to a portion of the distribution system owned by ENOI and be compliant with applicable laws, rules, codes, contractual requirements (including, without limitation, those in applicable interconnection contract(s)), and health and safety standards (such as, for purposes of illustration only, IEEE 1547). Resources proposed to be interconnected at a distribution voltage level should be designed to deliver three-phase alternating current at the required voltage to the distribution grid. Bidders will be required to furnish revenue quality metering equipment and systems (including RTU equipment) with power quality (harmonics, flicker, etc.) monitoring features, all meeting applicable ENOI requirements.

Bidders (or their designee) are expected to supply, own, and maintain, at their cost and expense, the step-up transformers associated with their resources. Step-up transformation equipment must be engineered so that the step-up transformation aligns with the distribution primary voltage in the interconnection area. The point of ownership transfer of a resource's interconnection facilities is expected to be the high-side of the associated step-up transformer(s). If a proposed step-up transformer for a resource proposed to be interconnected at a distribution level is greater than three (3) MVA, ENOI will require the installation of the transformer with a delta configuration on its secondary side.

To maintain reliability, a proposed interconnection may not exceed 15 - 20% of the peak load of the feeder distribution line to which the proposed resource intends to interconnect. ESI expects that any resource with a capacity that exceeds 15 - 20% of the peak load of the proposed interconnection feeder will require a dedicated feeder. As general guidance, resources with a capacity of 3 MW or greater are expected in most cases to exceed the 15 – 20% threshold described above and require a dedicated feeder. Bidders should note that resources with a capacity of less than 3 MW in many cases may also exceed the aforementioned threshold and require a dedicated feeder. In addition to the foregoing capacity guideline, Bidders should also be aware that, due to the potential for adverse reliability effects, there is a preference for resources to be located close to a substation.

The statements contained in this RFP are made subject to the Reservation of Rights set forth in Appendix E of this RFP and the terms and acknowledgements set forth in the Proposal Submission Agreement.

Bidders with resources expected to interconnect at a distribution level are strongly encouraged to contact the RFP Administrator for a three-phase feeder map and feeder datasheet for the ENOI service area. The information available on the map and datasheet should help Bidders determine whether their resources' size and proposed interconnection location relative to a substation are likely to meet the planning guidance described above.

If a proposed distribution-level resource is expected to cause power flows into the MISO System (*i.e.*, its generation output at any point in time is expected to exceed the current load on the feeder to which the proposed resource intends to interconnect), MISO may require upgrades to the distribution system and/or the transmission system to address any effect the resource's distribution-level interconnection would have on the MISO System. Each Bidder will be required to inform ESI whether its resource(s) will be registered as a small power production facility with QF status.

As with other interconnection-related costs, Bidders will be responsible for the costs of any required dedicated feeder and any upgrade costs related to a distribution interconnection and should take into account those costs in their proposals.

For a resource proposing to deliver energy to the Physical Delivery Point at a distribution level, ENOI expects to require that such resource, if contracted for pursuant to this RFP, be qualified as a Load Modifying Resource in MISO for the Delivery Term (in the case of PPAs) or from and after the closing of Transaction (in the case of acquisitions). The Definitive Agreement will require Seller, subject to ENOI's directions to the contrary, to take all actions necessary or advisable to cause the resource to be qualified and/or recognized in MISO for the Delivery Term or after the closing, as the case may be, as a Load Modifying Resource or another form of distribution-level resource recognized by MISO or the applicable Balancing Authority, and to cause ENOI to be eligible for and receive all distribution rights and entitlements associated with the contract Capacity of the resource.

## **2.4.2. Interconnection Service Applications**

### Transmission Service

Under the current MISO Rules, the receipt of transmission-level interconnection service from MISO, including, without limitation, ERIS and NRIS, requires the submission to MISO of a generator interconnection application under the applicable generator interconnection process. For a proposal based on a Developmental Resource that will be interconnected directly to the MISO System or an IS-Deficient Existing Resource interconnected directly to the MISO System, the generator interconnection application supporting such proposal must request at least the amount of NRIS necessary for the resource to obtain the Minimum Required NRIS Quantity and must be submitted to MISO on or before September 12, 2016. Bidder must provide a complete and accurate copy of the submitted MISO interconnection service application as part of its Proposal Package. Among other things, the submitted MISO application service must identify the location of the proposed Developmental Resource or IS-Deficient Existing Resource, the Balancing Authority

The statements contained in this RFP are made subject to the Reservation of Rights set forth in Appendix E of this RFP and the terms and acknowledgements set forth in the Proposal Submission Agreement.

substation to which the proposed Developmental Resource or IS-Deficient Resource would be interconnected, and the Electric Interconnection Point. It must also request at least the amount of NRIS necessary for the resource to receive the Minimum Required NRIS Quantity.

For transmission-level External Resources that are Developmental Resources or are Existing Resources that do not have the interconnection service necessary for the Minimum Required External Interconnection and Deliverability Service, Bidder must initiate the process and complete and submit to the applicable Balancing Authority the appropriate application(s), including the required supporting information, to receive such service. Bidder must provide as part of its Proposal Package a complete and accurate copy of each such application.

For Bidders offering a proposal backed by a Developmental Resource, an External Resource, or an IS-Deficient Existing Resource, it is not necessary for Bidder to have received the results of the interconnection or deliverability/transmission service study or executed an electric interconnection or deliverability/transmission service agreement in order to submit a proposal. Except to the extent ESI otherwise agrees in writing, any interconnection service or deliverability/transmission service application supporting a proposal will be required to remain in the queue for interconnection service or deliverability/transmission service until the proposal is eliminated from this RFP or the interconnection service or deliverability/transmission service, as the case may be, required by this RFP is obtained or conditionally granted. If a resource proposed by a Bidder in this RFP does not remain in the queue to obtain the required service or loses the right to obtain or receive such service during the pendency of this RFP, Bidder must promptly notify the RFP Administrator, and any Bidder proposal backed by such resource will be subject to elimination. Bidders should bear in mind that the generator interconnection and transmission/deliverability processes utilized by MISO and other Balancing Authorities operate on timelines and contain requirements that are independent of this RFP and may necessitate the expenditure of costs by Bidders for their proposed resources to remain in the queue.

### Distribution Service

Detailed information about the interconnection process for resources seeking to interconnect at a distribution service level, including applications for service, is available in Appendix H. Additional information regarding distribution-level interconnection applications and considerations can be found in Sections 2.4 and 2.4.1 above.

#### **2.4.3. Product Deliveries and Financial Settlement**

For any PPA arising out of this RFP, Seller will be required to make available contract Capacity and deliver contract energy and Other Electric Products at the Physical Delivery Point. If the resource is delivering power to the Physical Delivery Point at a transmission level, the financial settlement of contract energy and any Other Electric Product provided by Seller under the PPA will reflect the basis differential, if any, for energy or Other Electric Product between the CP Node at the applicable Physical Delivery Point and the ENOI Load Node in the applicable market (*e.g.*, day-

The statements contained in this RFP are made subject to the Reservation of Rights set forth in Appendix E of this RFP and the terms and acknowledgements set forth in the Proposal Submission Agreement.

ahead or real-time) and related deliverability, loss, and congestion costs (plus, if the applicable generation resource is an External Resource, any “into,” “through,” or similar charges or costs). In addition, with respect to each capacity-related benefit (*e.g.*, Capacity Credits) provided to ENOI under the PPA from any such resource, the benefit will reflect the price difference, if any, for the benefit in the Local Resource Zone (or comparable region) in which the Physical Delivery Point is located and the Local Resource Zone (or comparable region) in which ENOI’s service territory is located and related costs. If the resource is delivering power to the Physical Delivery Point at a distribution level, ESI’s current expectation is that the power will be considered a direct offset to ENOI’s load and will not require adjustment for basis differential and related costs.

#### **2.4.4. Scope of Responsibility**

Seller will be responsible for, and bear the full costs and risks of, the arrangement, procurement, receipt, and maintenance (for PPAs, prior to and throughout the Delivery Term, and for acquisitions, through closing) of the interconnection, deliverability, and transmission service required by this RFP or otherwise sought or obtained by or for Seller, including, without limitation, (i) the electric interconnection of the Facility to the host utility and the establishment of, and the injection of energy and Other Electric Products at, the Electric Interconnection Point, (ii) the transfer and delivery of Capacity, energy, and Other Electric Products to the Physical Delivery Point, and (iii) the financial settlement of energy and Other Electric Products at the ENOI Load Node (for transmission-level resources). Without limiting the foregoing, Seller will bear all:

- related interconnection, deliverability, or transmission/distribution request, application, study, registration, and comparable fees, charges, or costs;
- upgrade, improvement, and other fees, charges, and costs arising out of the requested interconnection, deliverability, or transmission/distribution service, except to the extent expressly stated to be the exclusive responsibility and cost of the host utility or an applicable transmission/distribution service provider, transmission/distribution owner, or Balancing Authority under the applicable tariffs, rules, regulations, or requirements of, or generator interconnection or other agreements with, the host utility or such transmission/distribution service provider, transmission/distribution owner, or Balancing Authority;
- upgrade, improvement, and other fees, charges, and costs arising out of Buyer’s request for full network integration transmission service for the energy delivered from the Facility (or portion thereof allocable to Buyer);
- fees, charges, and costs to receive interconnection, deliverability, transmission/distribution, and financial settlement service;
- transformer, line, energy, capacity, and other losses or costs related to the interconnection, deliverability, transmission/distribution, or financial settlement service with respect to the Facility (including, without limitation, any basis differential and associated costs between the Physical Delivery Point and the ENOI Load Node for resources interconnected at a transmission service level); and
- costs assigned or allocated to Seller or to a financially settling party under the applicable tariffs, rules, regulations, or requirements of, or agreements with, the host utility,

The statements contained in this RFP are made subject to the Reservation of Rights set forth in Appendix E of this RFP and the terms and acknowledgements set forth in the Proposal Submission Agreement.

transmission/distribution service provider, transmission/distribution owner, or any applicable Balancing Authority. Bidder will be responsible for reflecting these costs in Bidder's proposed pricing.

For acquisition proposals, the assets purchased by ENOI from Seller will include, without limitation, any and all transmission or distribution-related rights held by or for Seller or any Affiliate thereof as of the closing (including, without limitation, ARRs, FTRs, and other transmission or congestion-related rights), to the extent related to the acquired generation assets, and all rights to own, hold, manage, and control those rights.

Subject to certain limitations, throughout the term of any Definitive Agreement, ENOI will have the right to determine from time to time whether ENOI (or a designee) or Seller will serve as the "market participant" for the generation resource before MISO and how the resource will be registered with MISO. If ENOI directs that the proposed resource be registered with MISO as a Capacity Resource, ENOI currently expects that it will require Seller to serve as the market participant for the resource. As the market participant for such resource, Seller would be responsible for submitting financial schedules to MISO for deliveries of energy and Other Electric Products from the resource under the Definitive Agreement. Without limiting the terms of the first paragraph of this Section 2.4.4, Seller will be responsible for and bear any and all costs and risks associated with financially scheduling energy and Other Electric Products, including, without limitation, electric losses, MISO fees, charges, and other costs related thereto (*e.g.*, financial scheduling fees, administrative costs, transaction charges). If ENOI directs that the proposed resource be registered with MISO other than as a Capacity Resource (*e.g.*, as a Load Modifying Resource), ENOI currently expects that ENOI would serve as the market participant for the resource. In such event, Seller will be required to cooperate with ENOI to ensure that the registration and any qualification of the resource in MISO consistent with ENOI's directions (*e.g.*, as a Load Modifying Resource) is made in accordance with MISO Rules and ENOI's reasonable requirements, including, without limitation, with regard to generator availability forecasting. Please see Appendix B-1 for additional information regarding Seller's responsibilities and obligations if Seller is the market participant for a contracted resource with respect to a PPA under this RFP.

## 2.5. Cost Recovery

In PPAs arising out of this RFP, Sellers will be required to absorb the risks of the possible disallowance, disapproval, or denial of recovery by the City Council and/or other Governmental Authorities of ENOI costs incurred in connection with a PPA arising out of this RFP ("**Cost Recovery Risks**"), excluding certain limited Cost Recovery Risks that will remain with ENOI ("**ENOI-Allocated Cost Recovery Risks**"). ENOI-Allocated Cost Recovery Risks include (i) costs incurred by ENOI in connection with the applicable PPA for which recovery was expressly disallowed, disapproved, or denied by the City Council in its final order approving the PPA as in the public interest and prudent, provided ENOI accepted the order as satisfying the City Council regulatory approval condition to commencement of the PPA Delivery Term, and (ii) costs incurred by ENOI in connection with the applicable PPA due exclusively to the active fault of ENOI. Cost

The statements contained in this RFP are made subject to the Reservation of Rights set forth in Appendix E of this RFP and the terms and acknowledgements set forth in the Proposal Submission Agreement.

Recovery Risks expected to be borne by Sellers include, without limitation, unrecovered costs to replace capacity, energy, Environmental Attributes, and other products not provided to ENOI by Seller under the applicable PPA. ENOI is willing to consider (but is under no obligation to accept) Special Considerations or proposals from Bidders that propose with specificity a different treatment or apportionment between ENOI and Seller of Cost Recovery Risks and provide supporting rationale. Any proposed treatment of Cost Recovery Risks that would allocate all or substantially all Cost Recovery Risks to ENOI is not contemplated.

## **2.6. Design and Operating Considerations**

ESI requires that any Developmental Resource offered into this RFP meet the project criteria established in this RFP, including in Appendix D. Bidders should be prepared to submit a comprehensive response to the due diligence requests for information for Developmental Resources (Appendix C-1) and Existing Resources (Appendix C-2) on a proposed resource's ability to meet the requirements for such resource in this RFP. Responses will be part of the quantitative and qualitative evaluation of proposals submitted in response to this RFP.

## **3. SELF-BUILD OPTION**

ESI intends to develop and submit into this RFP a cost estimate for the Self-Build Option. The Self-Build Option is an Aggregated Solar PV Resource that will have a total Capacity of up to five (5) MW (AC). Each individual Solar PV resource comprising a portion of the Self-Build Option will be at least 100 kW (AC), located at a site within Orleans Parish, Louisiana, and interconnected at a distribution voltage level of at or less than 13.2 kV on ENOI's side of the electric meter. The Self-Build Option is expected to utilize existing buildings and properties, including customer-owned and ENOI or Affiliate-owned sites.

The Self-Build Option will be considered an alternative to, or in conjunction with, third-party proposals submitted into this RFP. If one or more third-party resources is selected for contract negotiations, ENOI may continue to take the steps necessary to preserve the Self-Build Option as a viable option in case negotiations with any third party do not lead to a Definitive Agreement. If selected in this RFP, the self-build resource is expected to be placed into commercial service by no later than June 1, 2020.

ESI will require that the Proposal Package for the Self-Build Option, including the cost estimate for the Self-Build Option, be submitted to the RFP Administrator and the IM prior to the receipt of proposals from any Bidder, and no later than 5 p.m. CPT on the Friday before the first day of the Proposal Submission Period. After the Proposal Submission Deadline, the IM and the RFP Administrator will provide redacted data and information from the proposals received to the Evaluation Teams (see Section 7 below) at approximately the same time. All proposals, including the Self-Build Option, will be evaluated on a consistent basis, as described in certain appendices to this RFP and in this Main Body, and, subject to the other terms hereof, on the time frame set forth in Section 4.1 below. As discussed in more detail in Appendix G, the Evaluation Teams (see Section 6

The statements contained in this RFP are made subject to the Reservation of Rights set forth in Appendix E of this RFP and the terms and acknowledgements set forth in the Proposal Submission Agreement.

below) will not include any member of the Entergy self-build commercial team or support services team working on the Self-Build Option and will operate independently of these two teams.

The IM, in consultation with ESI, may choose to retain an independent consulting engineer to evaluate the reasonableness of the construction cost estimates of the Self-Build Option and, potentially, to undertake a similar evaluation for any other Developmental Resource supporting a proposal submitted in this RFP. The IM may instead choose to assess the reasonableness of such estimates by reference to other relevant and competent information available to the IM. The IM will consult with ESI to (i) determine a process for selecting and retaining the independent consulting engineer, (ii) develop the scope of work to be performed by the consulting engineer, and (iii) determine how the engineer’s report will be utilized in this RFP. In addition, ESI may retain an independent consulting engineer to estimate the cost to Buyer to have an independent owner/buyer’s engineer monitor the development and construction of a proposed third-party resource after selection through the completion of construction and provide related engineering services to protect Buyer’s interest.

#### 4. RFP SCHEDULE

##### 4.1. Schedule

The RFP Schedule is critical for Bidders interested in participating in this RFP. The RFP Schedule in the table below sets out milestone events and dates for this RFP. RFP Schedule milestone events and dates are subject to change. After consultation with the IM, notice of any change to the then-current RFP Schedule will be posted on the 2016 ENOI Renewables RFP Website.

Milestone	Scheduled or Target Date
Final RFP Documents Issued	July 13, 2016
Bidder Registration Period	August 29-September 1, 2016
Final Date for Completion and Submission of Required Transmission-Level Interconnection Application to MISO	September 12, 2016
Final Date for Proposal Fee Payment	September 13, 2016
Self-Build Option Proposal Submission Deadline	September 30, 2016
Proposal Submission Period	October 3-6, 2016
Primary/Secondary Selection Lists Announced	April 2017
Comprehensive Negotiations and Due Diligence Begin	April 2017
Bidders Remaining on Secondary Selection List Released from Proposals	July 2017
Definitive Agreements Executed	September 2017
Regulatory Approval Process Complete	September 2018

The statements contained in this RFP are made subject to the Reservation of Rights set forth in Appendix E of this RFP and the terms and acknowledgements set forth in the Proposal Submission Agreement.



Bidders may offer a proposal with a proposed Delivery Term start date or closing date prior to September 2018, but are advised that the tentative milestone dates for completion of Definitive Agreements and the regulatory approval process do not support the timing of such a proposal. The actual dates for execution of the Definitive Agreements and the conclusion of the regulatory approval process could be sooner or later than the dates indicated above.

#### **4.2. Modifications of RFP Schedule**

Without limiting the generality of Appendix E, ESI reserves the right to withdraw, suspend, cancel, or terminate this RFP, or to modify any term of this RFP, including, without limitation, any term concerning the RFP Schedule (including any milestone or milestone date), at any time in its sole discretion. ESI will endeavor to notify all participants who have completed Bidder Registration of any such withdrawal, suspension, cancellation, termination, or modification made prior to the Proposal Submission Deadline and to post notice of any such action on the 2016 ENOI Renewables RFP Website.

### **5. RFP MILESTONES AND PROCESSES: RFP ISSUANCE THROUGH PROPOSAL SUBMISSION**

#### **5.1. Bidders Conference**

ESI hosted a conference/webcast on June 1, 2016 for potential Bidders in this RFP and other stakeholders (“**Bidders Conference**”). The conference/webcast gave participants a high-level overview of, and other information concerning, this RFP and related processes and was open to all interested Persons. ESI and ENOI personnel and the IM were available at the conference to answer questions about the RFP Schedule, the Bidder Registration Process, the Proposal Submission Process, the evaluation process, technical RFP issues, and proposed Transaction terms and conditions, and to respond to other requests for information about this RFP. ESI has posted the written materials presented during the conferences to the 2016 ENOI Renewables RFP Website. Bidders are advised that those materials may not duplicate all of the information provided at the conference.

#### **5.2. Bidder Registration**

To be eligible to submit a proposal, Bidder must complete the Bidder Registration Process, as described in this Section 5.2. Bidder Registration will begin at 8:00 a.m. CPT on the Bidder Registration start date specified in the applicable RFP Schedule and end at 5:00 p.m. CPT on the Bidder Registration end date specified in the applicable RFP Schedule (the “**Bidder Registration Period**,” and the deadline for Bidder Registration, the “**Bidder Registration Deadline**”).

The statements contained in this RFP are made subject to the Reservation of Rights set forth in Appendix E of this RFP and the terms and acknowledgements set forth in the Proposal Submission Agreement.

To register for this RFP, all Bidders, including, for purposes of this Section 5, those sponsoring the Self-Build Option, will be required to submit a completed Bidder Registration Agreement (including the Bidder Registration Form attached thereto) to the RFP Administrator via courier or electronic mail (as a .pdf attachment) by the Bidder Registration Deadline. **Bidders will bear the risk of failing to submit a completed Bidder Registration Agreement by the Bidder Registration Deadline.** The Bidder Registration Agreement must be executed by an officer or other representative of Bidder who is authorized to sign on Bidder's behalf. If delivery is made by electronic mail, Bidder must subsequently deliver to the RFP Administrator an original of the duly executed Bidder Registration Agreement by 5:00 p.m. CPT within three (3) Business Days after the Bidder Registration Deadline. Only Bidders registered in accordance with this RFP will be permitted to submit proposals in this RFP, and only proposals registered in accordance with this RFP will be eligible for submission.

Following submission of its completed Bidder Registration Agreement, Bidder will be issued a unique Bidder ID. In addition, each registered resource and proposal will receive its own Resource ID and Proposal ID. Bidder IDs, Resource IDs, and Proposal IDs will be used by Bidders in the Proposal Submission Process and in connection with the evaluation of proposal information received by ESI. The use of Bidder IDs, Resource IDs, and Proposal IDs is part of ESI's process to ensure that appropriate protections are in place to minimize the dissemination of information that explicitly identifies Bidders to Evaluation Team members who do not need to know that information.

Bidders are required to pay a Proposal Submittal Fee of \$5,000.00 *for each registered proposal.*<sup>2</sup> Proposals that are alternatives to each other will be considered separate proposals and must be registered as such. ESI will bill Bidder for the total Proposal Submittal Fees due from Bidder within three (3) Business Days after the end of the Bidder Registration Period. Bidder will be required to remit payment of the Proposal Submittal Fee in full in accordance with the instructions provided in the invoice. Payment will be due by the date specified in the applicable RFP Schedule. **Bidder's failure to submit the Proposal Submittal Fee for a proposal by the payment due date will cause Bidder to become ineligible to participate in this RFP with respect to such proposal.**

Proposal Submittal Fees will be refunded to Bidders only under the following circumstances:

1. Bidder registers a proposal and pays the Proposal Submittal Fee but does not complete Proposal Submission for that registered proposal;
2. Bidder registers a proposal, properly completes Proposal Submission, but subsequently withdraws the proposal prior to the Proposal Submission Deadline; or
3. ESI cancels or terminates this RFP prior to completion of the evaluation of proposals for the Primary Selection List or the Secondary Selection List.

---

<sup>2</sup> Since payment of the Proposal Submittal Fee would amount to (from a corporate perspective) a payment to themselves, the sponsors of the Self-Build Option are exempt from the Proposal Submittal Fee requirement.

The statements contained in this RFP are made subject to the Reservation of Rights set forth in Appendix E of this RFP and the terms and acknowledgements set forth in the Proposal Submission Agreement.

If Bidder, or any proposal submitted by Bidder, becomes ineligible or is eliminated from this RFP for any reason other than a reason set forth in (1) through (3) above, including, without limitation, if no proposals are selected for either the Primary Selection List or the Secondary Selection List after ESI has completed its evaluation of proposals, Bidder's Proposal Submittal Fee(s) will not be returned.

### 5.3. Proposal Submission

Subject to Section 5.2 above and Section 6.1 below, in order to have its proposal(s) evaluated under this RFP, the Proposal Submission Process requires each Bidder to submit to ESI:

- a completed Proposal Submission Template;
- a completed VAT self-assessment (discussed in Section 6.1.3 below);
- a completed accounting certification (discussed in Section 6.1.4 below);
- a complete set of the documents required to be provided by Bidder pursuant to Section 2.4 above; and
- completed responses to Appendix C-1 (for Developmental Resource proposals) or Appendix C-2 (for Existing Resource proposals) (collectively, the "**Proposal Package**").

The period during which any Bidder may submit a completed Proposal Package will begin at 8:00 a.m. CPT on the proposal submission start date specified in the applicable RFP Schedule and end at 5:00 p.m. CPT on the proposal submission end date specified in the applicable RFP Schedule (the "**Proposal Submission Period**," and the deadline for submission, the "**Proposal Submission Deadline**").

To submit proposals in this RFP, Bidders must deliver their completed Proposal Package to the RFP Administrator, by the Proposal Submission Deadline, (i) as files attached to electronic mail or other electronic/digital media acceptable to ESI or (ii) in a digital form acceptable to ESI (*e.g.*, a CD, a flash drive) delivered to the RFP Administrator by courier. Completed Proposal Submission Templates must be submitted in their native Excel form. The Entergy electronic communications network will not accept "zip" files or electronic mail with file attachments containing, individually or collectively, approximately ten (10) megabytes or more of data. Proposal information that is not accepted by the Entergy electronic communications network or is not properly addressed to and not timely received by the RFP Administrator will be considered undelivered. Proposals failing to provide complete responses as required may be considered non-conforming. Bidders should not send, and the RFP Administrator will not accept, paper copies of electronic proposals.

Bidders are also required to execute and deliver to the RFP Administrator the Proposal Submission Agreement by the Proposal Submission Deadline. The Proposal Submission Agreement must be executed by an officer or other representative of Bidder who is duly authorized to sign the Proposal Submission Agreement and tender the submitted proposal(s) on behalf of Bidder. Electronic or stamp signatures are not permitted. The Proposal Submission Agreement may be

The statements contained in this RFP are made subject to the Reservation of Rights set forth in Appendix E of this RFP and the terms and acknowledgements set forth in the Proposal Submission Agreement.

delivered to the RFP Administrator via courier or electronic mail (as a .pdf attachment). If delivery is made by electronic mail, Bidder must subsequently deliver to the RFP Administrator an original of the duly executed Bidder Proposal Submission Agreement (including hand-signed signature page) by 5:00 p.m. CPT within three (3) Business Days after the Proposal Submission Deadline.

After the RFP Administrator has electronically received Bidder's completed Proposal Package, Bidder will receive a confirming email from the RFP Administrator. Bidder should contact the RFP Administrator if a confirming email is not received within one (1) Business Day after Bidder's submission of the Proposal Submission Template and Proposal Submission Agreement.

**Bidder will bear the risk of any failure of Bidder to submit the completed Proposal Package by the Proposal Submission Deadline as required by this RFP. Proposals for which Bidder does not submit all agreements, information, and material as required by this RFP may be considered non-conforming and eliminated from consideration.**

#### **5.4. RFP Hotline**

A dedicated phone line (the "**RFP Hotline**") will be available to Bidders from 8:00 a.m. to 5:00 p.m. CPT on each Business Day throughout the Bidder Registration Period and the Proposal Submission Period. Bidders may use the RFP Hotline to ask technical or other questions regarding the Bidder Registration Process and the Proposal Submission Process. The RFP Hotline is not intended to serve as a means for Bidders to obtain general information about this RFP or other information that is not directly related to the Bidder Registration Process or the Proposal Submission Process (as applicable), and Bidders are asked to refrain from attempting to use the RFP Hotline for this purpose. The number for the RFP Hotline is (281) 297-3758.

### **6. RFP MILESTONES AND PROCESSES: PROPOSAL EVALUATION THROUGH CONTRACT NEGOTIATION**

#### **6.1. Overview and Assessments**

Following the Proposal Submission Deadline, the RFP evaluation will begin. In Phase I of this RFP ("**Phase I**"), proposals will be assessed for compliance with the Threshold Requirements. Proposals remaining in this RFP after the Threshold Requirements compliance review will then be evaluated in Phase I to identify the most economic proposals and significant high-level risks or RFP nonconformities associated with such proposals. Based on the Phase I evaluation results, ESI may reduce the number of proposals under consideration and may develop a preliminary shortlist of proposals (the "**Shortlist**"). Phase I will end after the completion of the Phase I evaluation of proposals and the establishment of the Shortlist or the determination by ENOI that the Shortlist is not necessary for this RFP. In Phase II of this RFP ("**Phase II**"), proposals placed on the Shortlist or otherwise remaining in this RFP will be evaluated in greater detail. Applying qualitative and quantitative assessments, the proposals in Phase II will be assigned a proposal ranking and a recommended disposition. A final list setting forth the proposal(s) (if any) selected for negotiation of

The statements contained in this RFP are made subject to the Reservation of Rights set forth in Appendix E of this RFP and the terms and acknowledgements set forth in the Proposal Submission Agreement.

a Definitive Agreement (the “**Primary Selection List**”) and the proposal(s) (if any) selected for possible negotiation of a Definitive Agreement (the “**Secondary Selection List**”) will be created.

After the selection process has been completed and any selections made, the RFP Administrator will notify each Bidder, with respect to each proposal it submitted, whether the proposal is on the Primary Selection List (if any), the Secondary Selection List (if any), or has been eliminated from further consideration in this RFP. Without limiting its rights under Exhibit E, ENOI expects to proceed to negotiate the terms of a Definitive Agreement with a Bidder having a proposal on the Primary Selection List. If those negotiations terminate or are suspended, or if ENOI determines negotiations with any Bidder having a proposal on the Secondary Selection List are appropriate, ENOI may negotiate commercial terms with one or more Bidders on the Secondary Selection List.

The proposal evaluation process in this RFP will be carried out by six (6) evaluation teams (each an “**Evaluation Team**”):

- the Economic Evaluation Team (“**EET**”);
- the Production Cost Assessment Team (“**PCAT**”), a team that supports the EET;
- the Viability Assessment Team (“**VAT**”);
- the Delivery Assessment Team (“**DAT**”), a sub-team of the VAT;
- the Accounting Evaluation Team (“**AET**”); and
- the Credit Evaluation Team (“**CET**”).

The roles and responsibilities of the Evaluation Teams are described in Sections 6.1.2 through 6.1.5 below. ESI may include as a member on any Evaluation Team, or contract with, any third-party agent, consultant, advisor, expert, contractor, or representative to assist in the evaluation of proposals as ESI deems necessary or appropriate.

Another team, the RFP Administration Team, will act to ensure that each Evaluation Team has the information needed to perform its analysis and act to facilitate the evaluation of proposals by all Evaluation Teams so that the evaluation process results in the proper assessment of the economics and other relevant elements of the proposals. The RFP Administration Team, in consultation with the IM and with ENOI’s approval, may also eliminate proposals from this RFP based on the team’s independent review of the proposals or recommendations or input provided by one or more of the Evaluation Teams. In addition, the RFP Administrator may consult with members of the RFP Administration Team from time to time on matters related to questions whether information regarding a proposal may be needed by or should be made available to an Evaluation Team. The RFP Administration Team will also prepare and distribute the results of this RFP to appropriate individuals at ENOI, ESI, and may recommend to ENOI the placement of proposals on the Primary Selection List or the Secondary Selection List or the elimination of proposals.

Each of the Evaluation Teams, the RFP Administration Team, and the RFP Administrator will have the right to ask Bidder clarifying questions to obtain additional information that it believes may

The statements contained in this RFP are made subject to the Reservation of Rights set forth in Appendix E of this RFP and the terms and acknowledgements set forth in the Proposal Submission Agreement.

help with its understanding, review, or analysis of Bidder's proposal or the Self-Build Option. Clarifying questions are expected to be communicated through the RFP Administrator via a clarifying letter. The RFP Administrator may also request Bidder's participation in one or more meetings to obtain clarification or additional information regarding a proposal. Upon the RFP Administrator's reasonable request and reasonable prior notice, Bidder will be expected to make available its duly authorized officers, representatives, and advisors to participate in meetings requested by the RFP Administrator, ESI, or ENOI and/or answer questions or provide information related to its proposal or participation in this RFP.

The evaluation process is designed to facilitate the fair and impartial evaluation of all proposals received in this RFP and to result in the selection of one or more proposals that meet the RFP's requirements and ENOI's needs at the lowest reasonable cost, taking into account reliability, risk, and other relevant factors. The process will be conducted in a carefully controlled manner, using procedures, methods, evaluation criteria, and assumptions that will be developed prior to the receipt of proposals. ESI will document key assumptions and model constructs and provide this documentation to the IM before the receipt of proposals; however, the Evaluation Teams will retain full discretion, subject to oversight by the IM, to use the evaluation methods and assumptions they consider appropriate to identify those proposals that best meet the needs of ENOI and the requirements and objectives of this RFP.

The IM will oversee the evaluation and selection process to ensure that the process is fair, objective, and impartial to all Bidders. The IM's responsibilities will include monitoring the precautions taken to restrict access to proposal information only to appropriate members of the Evaluation Teams in order to preserve the confidentiality of information contained in the proposals.

Any Bidder invited by ESI to finalize a Definitive Agreement will be expected to use its reasonable best efforts to take, or cause to be taken, all actions and to do, or cause to be done, all things necessary or appropriate to finalize, execute, and deliver such Definitive Agreement as promptly as possible.

#### **6.1.1. Threshold Requirements Assessments**

After the Proposal Submission Deadline, the necessary Evaluation Teams and/or the RFP Administration Team will review the proposals offered into this RFP in order to determine compliance with the Threshold Requirements. Proposals that fail to satisfy the Threshold Requirements may be eliminated from this RFP (after consultation with the IM). The retention of a proposal that fails to fulfill the Threshold Requirements after the initial Threshold Requirements evaluation does not preclude the subsequent elimination of the proposal from this RFP on account of such failure or for other reasons.

The statements contained in this RFP are made subject to the Reservation of Rights set forth in Appendix E of this RFP and the terms and acknowledgements set forth in the Proposal Submission Agreement.

### **6.1.2. Economic Assessments**

The EET is responsible for evaluating the economics of proposals received in this RFP and, with input from the PCAT, the DAT, the VAT, the AET, and the CET, developing the economic ranking of such proposals. The EET's evaluation will rely on tools and methods commonly used by ESI and ENOI for long-term planning and resource evaluations, including, without limitation, spreadsheet modeling and production cost modeling by the Aurora program. It may also utilize and rely on additional tools and methods that the EET deems necessary or appropriate for the effective assessment of proposal economics, including, but not limited to, qualitative considerations. In connection with its evaluations, the EET, in consultation with the IM, may perform sensitivity analyses. The EET will also review proposals for conformity with the Economic Assessment Threshold Requirements.

A preliminary process for the economic evaluation of proposals offered into the RFP follows. The actual process is expected to reflect adjustments made from time to time to the preliminary process.

#### Phase I

In Phase I, the EET will assess proposals for compliance with the Economic Assessment Threshold Requirements. Later in Phase I, it will perform a screening-level economic evaluation in order to identify the most economic proposals remaining in this RFP. A net benefit analysis based on spreadsheet models will be conducted as part of the Phase I evaluation. The net benefit of a proposal will be determined by subtracting the total fixed costs and variable costs from the projected capacity and energy revenues associated with the proposal. At the conclusion of its Phase I evaluation, the EET may recommend that ENOI eliminate specified proposals that are uneconomic relative to other proposals or the market.

#### Phase II

The purpose of the EET's Phase II economic evaluation will be to evaluate the proposals on the Shortlist or remaining in this RFP in greater detail. The Phase II evaluation may include an assessment of proposal's effect on ENOI's total supply cost. The EET may utilize variable supply cost saving estimates from a production cost model (Aurora), coupled with an assessment of each proposal's fixed costs, if any, and capacity benefit to determine the net supply cost benefit of the proposal.

#### Production Cost Assessment Team

The EET will be supported by the PCAT, a team separate and apart from the EET. The PCAT will use the Aurora production cost model to produce market energy prices relevant to the EET's economic analysis. The PCAT may also produce variable supply cost saving estimates for

The statements contained in this RFP are made subject to the Reservation of Rights set forth in Appendix E of this RFP and the terms and acknowledgements set forth in the Proposal Submission Agreement.

each proposal in Phase II. The PCAT's modeling results may then feed into the EET's economic evaluation models as inputs for its net supply cost benefit analysis.

### **6.1.3. Viability Assessments**

The VAT reviews and assesses the technical, environmental, interconnection, deliverability, transmission, energy source supply, and commercial merits of proposals. Each Bidder will be required to provide a self-assessment for each proposal it submits into this RFP.

The viability assessment will be carried out by subject matter experts (each, an "SME") who are members of the VAT. The subject matter expertise of VAT team members for this RFP includes:

- Plant & Equipment/Operations;
- Environmental;
- Commercial;
- Planning Analysis;
- Interconnection, Deliverability, and Transmission; and
- Other disciplines, as appropriate.

Each VAT SME will be responsible for providing an overview and assessment of each proposal with respect to his or her area(s) of expertise.

#### Phase I

In Phase I, near the beginning of the RFP evaluation, the VAT and/or the RFP Administration Team will review proposals for satisfaction of the Viability Assessment Threshold Requirements. The VAT and/or the RFP Administration Team will use information obtained from Bidder in its review, including Bidder's responses to the questions and requests included in Appendix C-1 or C-2 (as applicable) and information in the completed self-assessment form for the proposal. Bidders are encouraged to provide complete responses to Appendix C-1 or C-2 (as applicable) at the time they submit their proposals. Failure to provide a comprehensive response could negatively affect a proposal's Threshold Requirements evaluation or overall viability ranking. After the Threshold Requirements review, the VAT will review proposals remaining in this RFP for significant high-level risks or RFP nonconformities associated with such proposals that may be considered in the development of the Shortlist.

#### Phase II

In Phase II, the VAT will review the proposals remaining after Phase I to develop a more complete risk assessment and overall risk/viability profile of the proposals. The VAT's Phase II viability evaluation will be based on a qualitative assessment of various criteria in the general risk categories. This qualitative assessment will incorporate quantitative measures that result in an overall quantitative ranking for a proposal. A criteria and category score will be developed for the proposal

The statements contained in this RFP are made subject to the Reservation of Rights set forth in Appendix E of this RFP and the terms and acknowledgements set forth in the Proposal Submission Agreement.



by scoring multiple criteria in several risk categories, using defined ranking criteria. The weighted sum of each risk category's score will be totaled to determine the VAT's overall quantitative ranking for the proposal. The VAT will seek IM concurrence of the final viability ranking and VAT recommendation for each proposal assessed. The final viability ranking will be factored into the evaluation of proposals by the RFP Administration Team.

The VAT's Phase II risk and viability evaluations will include assessments of resource capabilities, project development risks (if applicable), environmental compliance risks, proposed commercial terms (including Special Considerations), resource deliverability, regulatory considerations, and other factors the VAT determines may bear on a proposal's risk and viability. The VAT may seek and incorporate into its viability assessments (in both Phase I and II) input from other Evaluation Teams. Without limiting Appendix E, ESI and ENOI will have the right to reject a proposal on the ground that the proposal, in the judgment of the applicable Evaluation Team(s), ESI, or ENOI, does not meet the criteria for viability established in connection with this RFP or otherwise is not viable.

#### Delivery Assessment Team

The DAT is a sub-team of the VAT with responsibility for the overall deliverability evaluation of proposals in this RFP. As part of the deliverability evaluation, the DAT may assess interconnection, deliverability, and transmission elements of a proposal offered into this RFP, including, without limitation, resource location, electric interconnection, network deliverability, and status of interconnection, transmission, and deliverability service requests or applications.

The DAT will review and assess generator interconnection and transmission service requests and applications made or to be made with respect to a resource offered in a proposal, as needed. The DAT will assist the VAT and/or the RFP Administration Team with the screening of proposals for compliance with certain of the Viability Assessment Threshold Requirements.

#### **6.1.4. Accounting Assessments**

The AET will perform an assessment of each proposed Definitive Agreement for a PPA to determine the accounting treatment of the PPA proposed. The assessment will include, but is not limited to, an analysis of:

- whether the proposed PPA contains a lease and, if so, whether the lease would result in the recognition of any long-term liability for ENOI or its Affiliates under the rules in effect during the term of the proposed PPA, in accordance with Financial Accounting Standards Board (“**FASB**”) Accounting Standards Codification (“**ASC**”) 840 and 842;
- whether the legal entity owning the subject generation asset during the contract term is a variable interest entity (“**VIE**”) and, if so, the entity required to consolidate the VIE

The statements contained in this RFP are made subject to the Reservation of Rights set forth in Appendix E of this RFP and the terms and acknowledgements set forth in the Proposal Submission Agreement.

throughout the term of the proposed Definitive Agreement, in accordance with FASB ASC 810;

- whether the proposed Definitive Agreement is or includes a derivative, and if so, the appropriate accounting for the derivative, in accordance with FASB ASC 815; and
- whether there are any other adverse accounting implications or effects to ENOI or any of its Affiliates arising out of the proposed Definitive Agreement.

The AET's accounting assessment of PPA proposals will include assessments based on the existing accounting standards at the time of the AET's assessment and/or those in effect during the term of any Definitive Agreement arising out of a proposal hereunder. Its assessment may also include assessments based on accounting standards that may be in effect if the AET determines that such standards will or may apply to any PPA arising out of a proposal hereunder and that it is feasible and appropriate for the AET to evaluate the proposal applying such standards.

ENOI will not enter into a PPA or any related agreement pursuant to this RFP that will or may result in the recognition of a long-term liability on the books of ENOI (or any of its Affiliates), whether the long-term liability is due to lease accounting, the accounting for a VIE or derivatives, or any other applicable accounting standard. If Bidder offers a PPA in a proposal submitted into this RFP, Bidder must include in the Proposal Package a certification from Bidder that, to the best of Bidder's knowledge, the proposed PPA will not result in, under the accounting standards in effect at the time of the certification or that will be in effect at any time during the contract term of the proposed PPA, the recognition of a long-term liability by ENOI or any of its Affiliates on its or any of its Affiliates' books. The certification must be prepared under the direction of and signed by the Principal Accounting Officer or other officer of Bidder, or a parent thereof, who performs a managerial accounting function, has expertise in the recognition of long-term liabilities by purchasers in PPAs, and has been involved in the preparation of the proposal ("**Accounting Officer**"). The certification must be prepared and dated reasonably contemporaneous with the submission date of the Proposal Package. The AET and/or RFP Administration Team will review each Proposal Package submitted into this RFP for compliance with the Accounting Assessment Threshold Requirements.

After the submission of the Proposal Package containing his or her certification, the Accounting Officer must promptly notify the RFP Administrator in writing of any development, event, or circumstance that would change, or could reasonably be expected to change, the accounting treatment of the proposed PPA included in the Proposal Package or otherwise would cause, or could reasonably be expected to cause, the certification of the Accounting Officer to be inaccurate or incomplete in any material respect.

Bidder will be required to make available to the AET or ESI all information and materials, including any and all assumptions made by Bidder, any of its Affiliates, or any of its or their representatives (*e.g.*, accounting firm), necessary for or reasonably requested by the AET or ESI to

The statements contained in this RFP are made subject to the Reservation of Rights set forth in Appendix E of this RFP and the terms and acknowledgements set forth in the Proposal Submission Agreement.

verify and/or independently determine the accounting treatment associated with a PPA proposed by Bidder and otherwise conduct its evaluation of Bidder's proposal.

#### **6.1.5. Credit/Collateral Assessments**

The CET will analyze each proposal, except the Self-Build Option, to assess potential credit risks and attendant collateral requirements. The CET's evaluation seeks to assure that the credit quality of Bidder (or, if different, Seller), when considered in light of its RFP proposal(s), complies with Entergy's corporate risk management standards and that any associated requirements for collateral or security to protect ENOI's interest in connection with a Definitive Agreement arising out of Bidder's proposal are identified. Subject to the proposal satisfying the Credit Assessment Threshold Requirements set forth in Section 2.3.4 above, the CET will not reject a proposal from consideration solely on the basis of credit. Appendix F contains additional information about the credit evaluation process and the credit requirements for this RFP.

#### **6.1.6. Resource Selection**

Using inputs provided by the Evaluation Teams, the RFP Administration Team will prepare a final report that ranks the evaluated proposals, provides the results of the RFP, and may make recommendations for selection of proposals on the Primary Selection List (if any) and, if it determines a Secondary Selection List is appropriate, the Secondary Selection List. The RFP Administration Team will select proposals recommended to be included on the Primary Selection List (if any) or the Secondary Selection List (if any) based on a variety of factors, including, but not limited to, relative economics, ability to meet relevant planning objectives (including diversification of technology and supply sources), deliverability, viability, accounting, and transactional considerations. The RFP Administration Team will provide the final report to members of the ENOI Operating Committee and other authorized recipients of the report that the RFP Administration Team deems appropriate. Any selections will be made the President and CEO of ENOI (or his or her designee).

### **6.2. Notification of Evaluation Results; Commercial Negotiations**

After the completion of Phase II, the RFP Administrator will communicate to each Bidder the status of its proposal(s) and whether additional discussions or negotiations are warranted. As noted, ENOI expects to negotiate the final terms of a Definitive Agreement with Bidder(s) on the Primary Selection List (if any), and may negotiate such terms with Bidder(s) on the Secondary Selection List (if any). Proposals not making either list will be considered rejected. A Bidder with a proposal on the Secondary Selection List will be released from its proposal three (3) months after notification of the proposal's placement on the Secondary Selection List, unless within that period Bidder has been invited to negotiate the terms of a Definitive Agreement under this RFP based on that proposal.

ESI's receipt of a proposal or the placement of a proposal on any preliminary compliance list, the Shortlist (or any other "short list" of proposals), the Primary Selection List, or the Secondary

The statements contained in this RFP are made subject to the Reservation of Rights set forth in Appendix E of this RFP and the terms and acknowledgements set forth in the Proposal Submission Agreement.

Selection List does not constitute or indicate ESI's or ENOI's agreement, commitment, representation, or promise to transact on the basis of the proposal or ESI's or ENOI's acceptance of any term of the proposal. Without limiting Appendix E, each of ESI and ENOI (i) has no obligation, and makes no commitment or promise, of any kind, to enter into a Transaction with any Bidder, including a Bidder with a proposal on the Primary Selection List, or to be bound by any term proposed by Bidder in this RFP, and (ii) more generally, has no obligation or liability of any kind whatsoever in connection with or arising out of this RFP except as and to the extent expressly set forth in a Definitive Agreement or a provision binding upon ESI or ENOI in a letter of intent (the "LOI") to which ESI or ENOI is a party.

As indicated in Appendix E, Bidder (or its designee) may be required to enter into an LOI with ESI or ENOI for the proposed Transaction pending the negotiation and execution of the Definitive Agreement. Upon execution of the LOI, Seller will be required to provide a letter of credit meeting the requirements set forth in Appendix F in the amount of \$100,000/MW for each MW of Capacity to be purchased under the proposed Transaction (plus up to an additional \$1,000,000.00 in the event the material and information provided in Bidder's response to Appendix D failed to meet the Minimum Requirements for Developmental Resources set forth in Appendix D and the discrepancy(-ies) have not been resolved to ESI's satisfaction).

## **7. MISCELLANEOUS RFP MATTERS**

### **7.1. Authorized Bidder Communications Channels**

The following communication restrictions became effective on May 6, 2016, and will continue through Bidder notification of the creation of the Primary Selection List (if any) and the Secondary Selection List (if any). Except as otherwise expressly provided in this RFP, all communications, including questions, regarding this RFP must be submitted in writing to the RFP Administrator (using the contact information provided above in Section 1.5). The IM will obtain and review all written communications between ESI and Bidders. The IM may comment on responses proposed by ESI prior to issuance, and ESI's responses may reflect input from the IM. Any contact or communication concerning this RFP (i) between Bidders, or representatives of Bidders, on the one hand, and personnel or employees of ESI other than the RFP Administrator, on the other hand, or (ii) between different Bidders, or representatives of different Bidders, made without the specific, prior written consent of the RFP Administrator after consultation with the IM or express authorization under this RFP, is, in each case, not allowed and grounds for disqualification of the non-compliant Bidder(s). Bidders are, of course, permitted to communicate internally within their organizations and to their representatives with regard to this RFP as necessary. Bidders may also communicate with the IM at any time.

### **7.2. Posting Questions**

Bidders and other interested Persons are invited to submit questions and comments about this RFP, including, without limitation, the Term Sheets, to the RFP Administrator, copying the IM

The statements contained in this RFP are made subject to the Reservation of Rights set forth in Appendix E of this RFP and the terms and acknowledgements set forth in the Proposal Submission Agreement.

(using the contact information provided above in Section 1.6). Alternatively, Bidder may submit questions exclusively to the IM (using the same contact information). All questions or comments regarding this RFP must be submitted in writing. Interested Persons are requested to submit questions as promptly as possible to ensure the timely receipt of ENOI's or ESI's response. ENOI requests that all questions be submitted to the RFP Administrator or the IM by no later than one week prior to the start of the Proposal Submission Period.

Subject to ESI's consideration of the confidentiality concerns described in Section 7.3 below, ESI intends to post questions submitted by Bidders, as well as ESI's responses to those questions, to the 2016 ENOI Renewables RFP Website. All questions will be posted anonymously, to shield the identity of Bidders who posed the questions. ESI's objective in posting questions and answers publicly is to afford Bidders equal access to information potentially relevant to their proposals.

ESI expects to provide answers to questions received during the Proposal Submission Period only to the extent the questions are specific to an actual proposal submission issue (and such answers may or may not be posted on the 2016 ENOI Renewables RFP Website).

### **7.3. Questions Involving Confidential Information**

Bidders should frame their questions, if possible, so that the answers do not require the disclosure of information that is confidential to ESI or ENOI, or any of their respective Affiliates. If ESI receives a question that calls for, in its opinion, an answer that would contain such confidential information and the provision of such confidential information is necessary and appropriate for ESI's response, then ESI will notify the IM and will respond to the question in writing, via certified mail, but only if Bidder posing the question has executed and returned to ESI a confidentiality agreement in substantially the form of the confidentiality agreement posted on the 2016 ENOI Renewables RFP Website. Given the communication protocols specified in Section 7.4 below, Bidders that intend to submit a proposal for a resource that will be interconnected at a distribution level within the ENOI Load Zone should expect to be required to execute a confidentiality agreement.

Similarly, Bidder's questions should be structured to avoid, if possible, the disclosure of Bidder's confidential information. If Bidder believes that certain Bidder information contained in a question it intends to submit is confidential, it is strongly urged to attempt to exclude such information, whether by redaction or other means, and then to submit the question. If Bidder believes it is necessary or advisable to submit the question without redacting or otherwise shielding its confidential information, Bidder should, without divulging its confidential information, notify the RFP Administrator in writing of the purpose of the question and the nature of the confidential information so that ESI can determine whether Bidder's question requires the disclosure, either by Bidder or by ESI, of Bidder's confidential information, or whether such disclosure is unnecessary or can be avoided. If ESI determines that the disclosure of confidential Bidder information is necessary and appropriate, ESI will notify the IM and ESI or ENOI will execute a confidentiality agreement acceptable to ESI so that the question may be submitted. Questions containing confidential Bidder

The statements contained in this RFP are made subject to the Reservation of Rights set forth in Appendix E of this RFP and the terms and acknowledgements set forth in the Proposal Submission Agreement.

information that are submitted timely will be answered by ESI by electronic mail or express mail sent to Bidder.

#### **7.4. Contact with MISO; Distribution-Related Communications**

Under the MISO Tariff, MISO currently provides functional supervision of the Entergy Transmission System and acts as transmission provider with respect to the granting of transmission service, including interconnection service, on the Entergy Transmission System or on other transmission systems under MISO's functional supervision. Inquiries about these aspects of the Entergy Transmission System or other transmission systems in MISO under MISO's functional supervision should be directed to MISO at its South Region Transmission Planning Office, (504) 846-7100. Bidders are directed to the MISO website, [www.misoenergy.org](http://www.misoenergy.org), for information about MISO.

Bidders should submit all questions, communications, or other correspondence regarding interconnections for distribution voltage level service or a related matter to the RFP Administrator. ESI requests that such questions, communication, or correspondence be provided in writing. Bidders that have had a proposal placed on the Primary Selection List or been directed by the RFP Administrator to submit a distribution level interconnection service application to ENOI prior to the proposal selection may begin to communicate directly with ENOI regarding interconnections for distribution voltage level service or related matters thereafter.

#### **7.5. Confidentiality Procedures for Bidder Registration and Proposal Submission Information**

ESI has procedures that its employees, agents, and consultants participating in the evaluation of proposals will be required to follow in order to protect the confidentiality of Bidder information provided in response to this RFP. The procedures are described in detail in Appendix G of this RFP but summarized in this Section 7.5. These procedures are designed and used so that information will be disclosed to the Evaluation Teams only to the extent deemed necessary for resource evaluation and to other employees, agents, and consultants of ESI or its Affiliates only to the extent deemed necessary for them to perform their functions related to this RFP.

All Persons having access to Bidder's confidential information in connection with this RFP will be contractually and/or professionally bound to protect that confidential information and to use it for no other purpose besides activities related to the resource evaluation process or the 2016 ENOI Renewables RFP process or other legitimate needs after consultation with the IM. Notwithstanding the foregoing or anything to the contrary in this RFP, ESI, ENOI, and their respective Affiliates will have no, and expressly disclaim any, liability to a Bidder for losses or damages of any kind resulting from any disclosure of any Bidder or proposal information.

Proposals or other information or correspondence submitted in response to this RFP will not be returned to Bidders. At the conclusion of this RFP process (including regulatory review of any

The statements contained in this RFP are made subject to the Reservation of Rights set forth in Appendix E of this RFP and the terms and acknowledgements set forth in the Proposal Submission Agreement.

transactions resulting from this RFP), except as otherwise provided in any confidentiality agreement entered into between ESI and Bidder, all proposals will be either destroyed or archived by ESI, subject to the procedures described in this section providing for the treatment of such proposals as confidential and any applicable Codes of Conduct.

All information contained in a proposal (i) may be required or requested to be disclosed by ESI or ENOI pursuant to any applicable law, rule, or regulation or in any legal proceeding involving ESI, ENOI, or any of their Affiliates and (ii) may be subject to review by one or more of the regulatory commissions, including their staffs, having jurisdiction over ESI and/or ENOI, in connection with any regulatory proceeding involving ESI or ENOI, or by any other Governmental Authority with jurisdiction over ESI, ENOI, or any Affiliate thereof over any matter related to this RFP, and may be subject to legal discovery or disclosure. By submitting a proposal into this RFP, Bidder agrees that ESI and ENOI may use and/or disclose any of the information contained in the proposal as information, testimony, or evidence in any proceeding or other matter (including in any filing in such proceeding or other matter) before any such regulatory commission or other Governmental Authority and may disclose any of such information when required or requested to do so in such proceeding or matter. In the event such information is to be so used or disclosed and such information is a pricing term, ESI or ENOI, as applicable, will use its good faith efforts to obtain from the regulatory commission or other Governmental Authority to whom such disclosure is being made, a confidentiality agreement, protective order, or other mechanism to protect the confidentiality of such information and to limit its dissemination. ESI or ENOI shall not, however, have any obligation to protect the confidentiality of a Bidder's pricing information in any application for approval by a Governmental Authority of any Definitive Agreement arising out of a proposal submitted by such Bidder in this RFP. ESI and ENOI can provide no assurance of the outcome of any attempt to obtain a confidentiality agreement, protective order, or other mechanism. In addition, ESI advises Bidders that intervenors, including merchant generators, in prior regulatory proceedings have sought access to confidential Bidder information in proceedings relating to previous RFPs or in which ESI and ENOI (or its predecessors) have been involved, and similar requests for access could be made in proceedings relating to this RFP.

#### **7.6. Affiliate Rules and Codes of Conduct**

All employees of ESI, any Entergy Operating Company, or any Entergy Competitive Affiliate must adhere to the Affiliate Rules and Codes of Conduct as applicable. A link providing access to complete copies of the Affiliate Rules and Codes of Conduct is available at the 2016 ENOI Renewables RFP Website.

#### **7.7. Multi-Person Bids**

If Bidder is comprised of more than one Person, the individual members may enter into contribution, indemnity, allocation, sharing, or other similar arrangements or agreements amongst themselves to allocate their respective rights and obligations; however, no such agreement or arrangement will affect any right reserved to ESI or ENOI in connection with this RFP or otherwise

The statements contained in this RFP are made subject to the Reservation of Rights set forth in Appendix E of this RFP and the terms and acknowledgements set forth in the Proposal Submission Agreement.

disadvantage ESI relative to its position with other Bidders without ESI's prior written agreement, either on its own behalf or as agent of ENOI. Bidder must fully disclose to the RFP Administrator all such contribution, indemnity, allocation, sharing, or similar arrangements or agreements. Disclosure may be accomplished by means of a written letter to the RFP Administrator by the proposal submission deadline. Bidder may be required to respond to subsequent diligence inquiries concerning the arrangements or agreements.

The statements contained in this RFP are made subject to the Reservation of Rights set forth in Appendix E of this RFP and the terms and acknowledgements set forth in the Proposal Submission Agreement.

2016 ENOI RENEWABLES RFP





***Appendix A***

***Glossary***

***For***

***2016 Request For Proposals***

***For***

***Long-Term Renewable***

***Generation Resources***

***For Entergy New Orleans, Inc.***

Entergy Services, Inc.  
July 13, 2016

## APPENDIX A

### GLOSSARY

“2016 ENOI Renewables RFP Website” means the internet website <https://spofossil.entergy.com/ENTRFP/SEND/2016ENOIREnewableRFP/Index.htm>.

“Accounting Assessment Threshold Requirements” means the Threshold Requirements described in Section 2.3.3 of the Main Body.

“Accounting Evaluation Team” or “AET” means the Evaluation Team responsible for performing an assessment of Bidder proposals for PPAs to determine the accounting treatment with respect to each such proposal (as further described in Section 6.1.4 of the Main Body).

“Accounting Officer” means the Principal Accounting Officer (under the Securities and Exchange Commission rules) or other officer of Bidder, or a parent thereof, who performs a managerial accounting function, has expertise in the recognition of long-term liabilities by purchasers in PPAs, and has been involved in the preparation of Bidder’s proposal.

“Affiliate” means, with respect to any specified Person, any other Person directly or indirectly controlling or controlled by or under direct or indirect common control with such specified Person. For purposes of this definition, “control” (including, with correlative meanings, the terms “controlling,” “controlled by,” and “under common control with”), as used with respect to any Person, shall mean the possession, directly or indirectly, of the power to direct or cause the direction of the management or policies of such Person, whether through the ownership of voting securities or interests having voting power, by agreement, or otherwise.

“Affiliate Rules” means rules and regulations promulgated by federal, state, and local regulatory agencies to address interactions between a utility and its affiliates engaged in competitive markets; settlement agreements between an Entergy Operating Company and a regulatory agency to address such interactions; and FERC-ordered standards of conduct to address interactions between transmission function and marketing functions employees.

“Aggregated Solar PV Resource” means multiple Solar PV facilities interconnected at a distribution voltage (less than 69 kV).

“ASC” means the Accounting Standards Codification.

“Balancing Authority” means the Person(s) in control of the physical operating of, and responsible for fulfilling the duties necessary to operate, a Balancing Authority Area.

“Balancing Authority Area” means an electric power system or combination of electric power systems to which a common automatic generation control scheme is applied in order to: (i) match, at all times, the power output of the generators within such electric power system(s) and

The statements contained in this Appendix A are made subject to the Reservation of Rights set forth in Appendix E of this RFP and the terms and acknowledgements set forth in the Proposal Submission Agreement.

**APPENDIX A  
GLOSSARY**

the net power purchased from or sold to Persons outside such electric power system(s) with the load within such electric power system(s); (ii) maintain scheduled interchange with other such electric power system(s), within the limits of accepted electrical practices; (iii) maintain the frequency of such electric power system(s) within reasonable limits in accordance with accepted electrical practices; and (iv) provide sufficient generating capacity to maintain operating reserves in accordance with accepted electrical practices.

“Bidder” means a Person that submits (or, prior to the applicable due date, intends or expects to submit) a proposal or completes the Bidder Registration Process in response to this RFP, or any group of Persons having a pre-existing contractual relationship, such as co-owners of a resource, that submits jointly (or, prior to the due date, intends or expects to submit jointly) a proposal or completes the Bidder Registration Process in response to this RFP based on such pre-existing contractual relationship. A group of Persons that has jointly developed a proposal pursuant to the procedures set forth in the Main Body may also be a “Bidder.”

“Bidder ID” means the unique Bidder identification number assigned to Bidder during the Bidder registration process.

“Bidder Registration Agreement” means the Bidder Registration Agreement described in Section 5.2 of the Main Body that Bidders are required to submit to ESI in order to participate in this RFP.

“Bidder Registration Deadline” means the deadline for Bidder Registration, which will be 5:00 p.m. CPT on the date specified in the applicable RFP Schedule as the end of the Bidder Registration Period.

“Bidder Registration Period” means the period of time provided for Bidder Registration, which, in general, will begin at 8:00 a.m. CPT on the date specified in the applicable RFP Schedule as the beginning of the Bidder Registration Period (under the RFP Schedule in effect as of the date of posting of this Appendix A, August 29, 2016) and will end at the Bidder Registration Deadline.

“Bidder Registration Process” means the process (described in Section 5.2 of the Main Body) for Bidders to register the entity submitting its proposal(s), the generation resource(s), and each proposal it intends to submit in response to this RFP.

“Bidders Conference” means the conference relating to this RFP described in Section 5.1 of the Main Body and held on the date for the Bidders Conference set forth in Section 4.1 of the Main Body.

“Business Day” means any day except Saturday, Sunday, or, with respect to the scheduling, bidding, and/or offering of power, a holiday as defined by the North American Electric Reliability Council or any successor organization thereto or, with respect to payments and all other matters, a holiday observed by Federal Reserve Banks in New York, New York. For

The statements contained in this Appendix A are made subject to the Reservation of Rights set forth in Appendix E of this RFP and the terms and acknowledgements set forth in the Proposal Submission Agreement.

**APPENDIX A  
GLOSSARY**

notice purposes, a Business Day shall begin at 8:00 a.m. and end at 5:00 p.m. Central Prevailing Time.

“Buyer” means ENOI.

“Capacity” or, as the context requires, “capacity” means the megawatt output level that the resource is capable, as of a given moment, of continuously producing and making available at the Electric Interconnection Point, taking into account the restrictions on operation, the operating condition of the equipment at that time, the auxiliary loads, line losses, and other relevant factors prior to the Physical Delivery Point. For purposes of this RFP, the term “Capacity” or “capacity” includes any and all capacity-related benefits associated with such Capacity, notwithstanding any provision in which “Capacity” or “capacity” is followed by the term “capacity-related benefit(s).”

“Capacity Credits” means ZRCs or (i) if ZRCs are no longer recognized by MISO, such other form of capacity credits or capacity-related benefits that replaces ZRCs and that MISO recognizes for use in the satisfaction of MISO’s resource adequacy requirements or (ii) if a Balancing Authority other than MISO is the applicable Balancing Authority, such other form of capacity credits or capacity-related benefits that such Balancing Authority recognizes for use in the satisfaction of its resource adequacy or other similar requirements.

“Capacity Resource” means any Generation Resource, Dispatchable Intermittent Resource, External Resource, or Intermittent Generation that is available to meet Demand (as each such capitalized term is defined in the MISO Rules). For the avoidance of doubt, “Capacity Resource” does not include any Load Modifying Resource.

“City Council” means New Orleans City Council

“Contract Capacity Maximums” means the maximum contract Capacities for given resources as set forth in Section 1.10 of the Main Body.

“Contract Capacity Minimums” means the minimum contract Capacities for given resources as set forth in Section 1.10 of the Main Body.

“Cost Recovery Risks” means the risks of the possible disallowance, disapproval, or denial of recovery by the City Council and/or other Governmental Authorities of ENOI costs incurred in connection with a PPA arising out of this RFP, as further described in Section 2.5 of the Main Body.

“CP Node” mean commercial pricing node.

“CPT” or “Central Prevailing Time” means the local time in New Orleans, Louisiana.

“Credit Assessment Threshold Requirements” means the Threshold Requirements described in Section 2.3.4 of the Main Body.

The statements contained in this Appendix A are made subject to the Reservation of Rights set forth in Appendix E of this RFP and the terms and acknowledgements set forth in the Proposal Submission Agreement.

**APPENDIX A  
GLOSSARY**

“Credit Evaluation Team” or “CET” means the Evaluation Team responsible for analyzing potential credit issues associated with Bidder proposals submitted in response to this RFP, as further described in Section 6.1.5 of the Main Body and Appendix F to this RFP.

“Credit Support Provider” means any Person that Bidder proposes in a proposal under this RFP as a credit support provider on its behalf.

“Definitive Agreement” means a legally binding agreement, mutually executed and delivered by authorized representatives of Buyer and Seller, setting forth the definitive terms and conditions of a Transaction. For the avoidance of doubt, a “Definitive Agreement” does not include a letter of intent, memorandum of understanding, or any other similar preliminary written agreement or document with respect to the Transaction, or any acceptance, written, oral, or other, of any offer or proposal.

“Deliverability Assessment Team” or “DAT” means the Evaluation Team that is a sub-team of the VAT with responsibility for the overall deliverability evaluation of proposals in this RFP (as further described in Section 6.1.3 of the Main Body).

“Delivery Term” means the period of time in which Seller is obligated to sell energy, Environmental Attributes, Capacity, capacity-related benefits, and Other Electric Products to Buyer and Buyer is obligated to purchase energy under the Definitive Agreement. The “Delivery Term” is, for purposes of this RFP, limited to PPAs and is more particularly described in Appendix B-1 to this RFP.

“Developmental Resource” means a Facility that, as of the date of Bidder’s proposal with respect to such Facility and the execution of the Definitive Agreement (if any) in respect of such proposal, (i) (a) has never been placed into commercial service and has not been accepted by its owner as having achieved (or been deemed to have achieved) the requirements for commercial operation or other similar state of completion under the applicable project construction contracts or (b) has been and remains removed from commercial service and (ii) will make available and generate the power to be provided to Buyer under the Definitive Agreement from new power generation equipment that meets the requirements of this RFP.

“Economic Assessment Threshold Requirements” means the Threshold Requirements described in Section 2.3.1 of the Main Body.

“Economic Evaluation Team” or “EET” means the Evaluation Team responsible for analyzing the economics of Bidder proposals submitted in response to this RFP (as further described in Section 6.1.2 of the Main Body).

“Electric Interconnection Point” means the point of electrical interconnection at the Balancing Authority substation to which the proposed generation resource would be interconnected at a transmission or distribution level and, for a resource interconnected at a transmission voltage level (69 kV and higher) is recognized by the applicable Balancing Authority as the CP Node (or equivalent) for the resource.

The statements contained in this Appendix A are made subject to the Reservation of Rights set forth in Appendix E of this RFP and the terms and acknowledgements set forth in the Proposal Submission Agreement.

**APPENDIX A  
GLOSSARY**

“Eligible Participants” means Persons eligible to participate in this RFP (as further described in Section 1.7 of the Main Body).

“ENOI” means Entergy New Orleans, Inc.

“ENOI-Allocated Cost Recovery Risks” means those certain limited Cost Recovery Risks that will remain with ENOI, as further described in Section 2.5 of the Main Body.

“ENOI Load Node” means the CP Node for the New Orleans Load Zone (EES. NOPLD).

“Entergy Competitive Affiliate” means any Affiliate of Entergy Corporation, other than ESI, Entergy Operations, Inc., any of the Entergy Operating Companies, or System Energy Resources, Inc.

“Entergy Operating Companies” or “Operating Company” means the regulated electric utilities owned, directly or indirectly, by Entergy Corporation. As of the date of this RFP, the Entergy Operating Companies are Entergy Arkansas, Inc., Entergy Louisiana, LLC, Entergy Mississippi, Inc., Entergy New Orleans, Inc., and Entergy Texas, Inc.

“Entergy Transmission System” means the interconnected group of transmission lines and substations owned or leased by the Entergy Operating Companies, that are used to transfer bulk electricity between supply and delivery points, regardless of the Balancing Authority (including any RTO or ISO) applicable thereto.

“Environmental Attributes” means all current or future RECs and all other current or future environmental attributes associated with the Capacity of the resource contracted to Buyer or the generation of energy from such Capacity, including any environmental attributes related to the avoidance of the emission of any gas (including carbon dioxide and other greenhouse gases), chemical or other substance into the environment.

“ERIS” means energy resource interconnection service, as described in the MISO Rules.

“ESI” means Entergy Services, Inc.

“Evaluation Team” means the group of individuals responsible for evaluating one or more aspects of the proposals (or specific components thereof) submitted in response to this RFP. The Evaluation Teams consist of the Economic Evaluation Team, the Production Cost Assessment Team, the Viability Assessment Team, the Accounting Evaluation Team, the Deliverability Assessment Team, and the Credit Evaluation Team, all as more particularly described in the Main Body.

“Existing Resource” means a renewable electric generation resource that is not a Developmental Resource.

“External Resource” a Developmental Resource that will not be or an Existing Resource that is not directly interconnected to the MISO transmission system.

The statements contained in this Appendix A are made subject to the Reservation of Rights set forth in Appendix E of this RFP and the terms and acknowledgements set forth in the Proposal Submission Agreement.

**APPENDIX A  
GLOSSARY**

“Facility” means the renewable electric generation facility specified as such in a Bidder proposal.

“FASB” means the Financial Accounting Standards Board, or any successor thereto.

“FERC” means the Federal Energy Regulatory Commission, or any successor thereto.

“Governmental Authority” means any federal, foreign, state, local, or municipal governmental body; any governmental, quasi-governmental, regulatory or administrative agency, commission, body, or other authority (including FERC, any electric reliability organization, any market monitor, any independent coordinator of transmission, any Balancing Authority (including any ISO or RTO), and any other transmission provider) exercising or entitled to exercise any administrative, executive, judicial, legislative, policy, regulatory, or taxing authority or power; or any court or governmental tribunal.

“Independent Monitor” or “IM” means Mr. Wayne Oliver of Merrimack Energy Group, Inc., an independent consulting firm retained by ESI to act as independent monitor for this RFP.

“IS-Deficient Existing Resource” means an Existing Resource interconnected to the MISO System that does not have, or that MISO has not conditionally granted, the Minimum Required NRIS Quantity.

“ISO” means a Person operating a transmission system and determined by the FERC to be an Independent System Operator.

“kW” means kilowatt, a unit of electrical power equal to one thousand watts.

“kWh” means kilowatt-hour, a basic unit for measuring the flow of electric energy. A kWh is equal to one kilowatt of power supplied continuously for one hour (or the amount of electricity needed to light ten 100-watt light bulbs for one hour).

“Letter of Intent” or “LOI” means a letter of intent between Buyer and Bidder (or authorized Seller) with respect to a proposal submitted by Bidder pursuant to this RFP and selected by ESI for negotiation of a Definitive Agreement.

“Load Modifying Resource” has the meaning given to such term in the MISO Rules.

“Long-Term Network Resource” means a generating resource that has qualified for network integration transmission service for one year or longer provided under the MISO OATT.

“LRZ 9” means the area defined in the MISO Rules as Local Resource Zone 9. LRZ 9 is depicted in Section 1.2 of the Main Body.

“Main Body” means the main document describing this RFP and to which ten (10) appendices are attached.

The statements contained in this Appendix A are made subject to the Reservation of Rights set forth in Appendix E of this RFP and the terms and acknowledgements set forth in the Proposal Submission Agreement.

**APPENDIX A  
GLOSSARY**

“Minimum Required External Interconnection and Deliverability Service” means interconnection service and firm deliverability/transmission service from the applicable External Resource to the Physical Delivery Point in amount(s) sufficient to enable Seller to deliver the maximum amount of contract energy that Seller may deliver to the Physical Delivery Point under the Definitive Agreement as proposed by Bidder or permitted under the Definitive Agreement.

“Minimum Required NRIS Quantity” means a quantity of NRIS that (i) is sufficient to allow the resource to be eligible to receive, throughout the Delivery Term for PPA Products and at the time of Transaction closing for Acquisition Products, the maximum Capacity Credits a resource of its Capacity size can receive under the MISO Rules (for proposals offering the full amount of the Capacity of the resource) or (ii) can and will be allocated and prioritized such that the NRIS level associated with the resource’s Capacity under contract to Buyer cannot limit the amount of MISO Capacity Credits that Buyer would receive for any planning period during the Delivery Term (for proposals offering less than the full amount of the Capacity of the resource).

“Minimum Requirements for Developmental Resources” means the minimum requirements that Bidders must satisfy in order for Bidder to be assured that a conforming proposal offering a Developmental Resource will be considered in this RFP. The Minimum Requirements for Developmental Resources are set forth in Appendix D to this RFP (Minimum Requirements for Developmental Resources).

“MISO” means Midcontinent Independent System Operator, Inc.

“MISO OATT” means the Open Access Transmission Tariff of MISO, filed at FERC in compliance with FERC Order Nos. 888 and 890.

“MISO Rules” means, collectively, (i) the MISO OATT on file with FERC, (ii) the MISO Business Practice Manuals, and (iii) any other applicable policies, rules, guidelines, procedures, protocols, standards, criteria, instructions, directives, and requirements of MISO.

“MISO South” means the area defined in the MISO Rules as MISO South. MISO South is depicted in Section 1.2 of the Main Body.

“MISO System” means the interconnected group of transmission systems coordinated, controlled, and monitored by MISO.

“Moody’s” means Moody’s Investors Service, Inc.

“MW” means megawatt, a unit of electrical power equal to one million watts or one thousand kilowatts.

“MWh” means megawatt-hour, a unit of electrical energy equal to one MW delivered for one hour.

“NRIS” means network resource interconnection service, as described in the MISO Rules.

The statements contained in this Appendix A are made subject to the Reservation of Rights set forth in Appendix E of this RFP and the terms and acknowledgements set forth in the Proposal Submission Agreement.



**APPENDIX A  
GLOSSARY**

“Other Electric Products” or “ancillary services” means reactive power production, reactive power absorption, voltage control, regulation and frequency response, energy balancing, load following, reserves and any other services, capabilities or products (including any ancillary services, but excluding any Capacity Credit or similar right or benefit or Environmental Attribute) available from or associated with the Capacity and energy to which Buyer is entitled under the applicable Definitive Agreement.

“Person(s)” means any individual, Governmental Authority, corporation, limited liability company, partnership, limited partnership, trust, association, bank, financial institution, fund or other entity.

“Phase I” means the phase of the RFP during which proposals will be assessed for compliance with the Threshold Requirements, as further described in Section 6.1 of the Main Body.

“Phase II” means the phase of the RFP during which proposals placed on the Shortlist or otherwise remaining in the RFP will be evaluated in greater detail, as further described in Section 6.1 of the Main Body.

“Physical Delivery Point” means the electrical interconnection point and/or CP Node at which energy and other products contracted for by ENOI from Seller pursuant to this RFP are physically delivered by Seller under the Definitive Agreement. For a Developmental Resource or an Existing Resource that is directly interconnected to the MISO System at a transmission voltage level (69 kV and higher) or the ENOI distribution system at a distribution voltage level (less than 69 kV), the Physical Delivery Point will be the Electric Interconnection Point, expected to be as specified by Bidder in the applicable proposal. For a Developmental Resource or an Existing Resource that is not directly interconnected to the MISO System at a transmission voltage level or the ENOI distribution system at a distribution voltage level, the Physical Delivery Point will be the point/CP Node at which energy and other products contracted for by ENOI from Seller pursuant to this RFP are physically delivered by Seller under the Definitive Agreement to MISO South, expected to be as specified by Bidder in the applicable proposal.

“PPA” means a power purchase agreement.

“Primary Selection List” means a final list setting forth the proposal(s) selected for negotiation of Definitive Agreement(s).

“Production Cost Assessment Team” or “PCAT” means the Evaluation Team supporting the EET that will use the Aurora production cost model to produce market energy prices relevant to the EET’s economic analysis (as further described in Section 6.1.2 of the Main Body).

“Products” means the PPA and asset acquisition products solicited by this RFP and described in Section 2.2 of the Main Body and in the Term Sheets.

“Proposal ID” means the unique proposal identification number assigned to Bidder for each proposal that Bidder registers during the Bidder Registration Process.

The statements contained in this Appendix A are made subject to the Reservation of Rights set forth in Appendix E of this RFP and the terms and acknowledgements set forth in the Proposal Submission Agreement.

**APPENDIX A  
GLOSSARY**

“Proposal Package” means a completed Proposal Submission Template, a completed VAT self-assessment, a completed accounting certification, a complete set of the documents required to be provided by Bidder pursuant to Section 2.4 of the Main Body, and completed responses to Appendix C-1 or Appendix C-2, as applicable, each as more fully described in Section 5.3 of the Main Body.

“Proposal Submission Agreement” means the Proposal Submission Agreement that each Bidder is required to execute and deliver to ESI as part of the Proposal Submission Process.

“Proposal Submission Deadline” means 5:00 p.m. CPT on the date specified in the applicable RFP Schedule as the last date for Bidders to submit Proposal Packages (under the RFP Schedule in effect as of the date of posting of this Appendix A, October 6, 2016).

“Proposal Submission Period” means the period during which any Bidder may submit a completed Proposal Package beginning at 8:00 a.m. CPT on the date specified in the applicable RFP Schedule as the first date for Bidders to submit Proposal Packages (under the current RFP Schedule, October 3, 2016) and ending at the Proposal Submission Deadline.

“Proposal Submission Process” means the process (described in Section 5.3 of the Main Body) for the submission of Bidder proposals and required documents to ESI in this RFP.

“Proposal Submission Template” means the template that will be used to submit a portion of Bidder’s proposal. The Proposal Submission Template will be submitted as part of the Bidder’s Proposal Package.

“Proposal Submittal Fee” means the amount due from Bidder for each registered proposal submitted by Bidder prior to the deadline for submitting proposals under this RFP, as further described in Section 5.2 of the Main Body.

“Published Credit Rating” means, with respect to any Person, the unsecured, senior long-term debt rating (not supported by any third party credit enhancement) of such Person or, if there is no such rating, the long-term issuer rating of such Person, in each case assigned by S&P or its successor or Moody’s or its successor. In the event of a “split” rating between S&P and Moody’s, the lower of the two credit ratings will apply.

“Qualifying Facility” or “QF” means a cogeneration or small power production facility that meets the requirements for qualifying facility status under the Public Utility Regulatory Policies Act of 1978, as amended, and the applicable federal and state implementing regulations.

“RECs” means any and all renewable energy credits, renewable energy or green certificates, green tags, and other fuel, emissions, air quality, or other environmental characteristics, credits, benefits, reductions, offsets, and allowances arising out of any applicable law or out of any voluntary rules, guidelines, or programs, including any such applicable law or voluntary rule, guideline, or program relating to any avoided, reduced, displaced, or off-set emissions of sulfur dioxides (SO<sub>x</sub>), nitrogen oxides (NO<sub>x</sub>), carbon monoxide (CO), mercury (Hg), soot, particulates,

The statements contained in this Appendix A are made subject to the Reservation of Rights set forth in Appendix E of this RFP and the terms and acknowledgements set forth in the Proposal Submission Agreement.

**APPENDIX A  
GLOSSARY**

carbon dioxide (CO<sub>2</sub>), and any other greenhouse gas (GHG) or pollutant that is now or may in the future be regulated under applicable laws or any voluntary rules, guidelines, or programs.

“Regional Transmission Organization” or “RTO” means any Person that satisfies the characteristics and functions of Regional Transmission Organizations as set forth in 18 C.F.R. 35.34. The RTO is voluntary in each region and may include transmission system owners, wholesale purchasers, and independent power generators.

“Resource ID” means the unique resource identification number assigned to Bidder for each generating plant (or portion thereof) that Bidder registers during the Bidder Registration Process.

“RFP” means this 2016 Request for Proposals for Long-Term Renewable Generation Resources for Entergy New Orleans, Inc., dated July 13, 2016 (including all Appendices and other attachments thereto).

“RFP Administration Team” means the RFP team that performs the functions of the RFP Administration Team described in Section 6.1 of the Main Body.

“RFP Administrator” means the individual identified in Section 1.5 of the Main Body (or any successor to such individual) who, among other things, (i) acts as a liaison between the participants in this RFP and ESI on all RFP-related matters, (ii) ensures that Bidder questions ESI receives are addressed in an appropriate manner, (iii) receives, records and maintains Bidder proposals, (iv) interacts with the IM, and (v) manages other administrative matters relating to this RFP.

“RFP-Eligible Resources” means resources eligible to participate in this RFP (as further described in Section 1.9 of the Main Body).

“RFP-Eligible Technologies” means the generation technologies eligible to participate in this RFP (as further described in Section 1.8 of the Main Body).

“RFP Hotline” means the dedicated phone line available from 8:00 a.m. to 5:00 p.m. CPT on each Business Day throughout the Bidder Registration Period and the Proposal Submission Period.

“RFP Schedule” means the schedule of milestones related to this RFP set forth in Section 4.1 of the Main Body, as may be modified by ESI from time to time in accordance with this RFP.

“S&P” means Standard & Poor’s Financial Services LLC.

“Secondary Selection List” means a final list setting forth the proposal(s) selected for possible negotiation of Definitive Agreement(s).

“Self-Build Option” means a self-build Aggregated Solar PV Resource generally described in this RFP, including Section 3 of the Main Body.

The statements contained in this Appendix A are made subject to the Reservation of Rights set forth in Appendix E of this RFP and the terms and acknowledgements set forth in the Proposal Submission Agreement.

**APPENDIX A  
GLOSSARY**

“Seller” means a Bidder, or other Person designated by such Bidder in its proposal, to enter into a Definitive Agreement with Buyer pursuant to this RFP process if such Bidder’s proposal is selected by ESI.

“Shortlist” means the preliminary shortlist of proposals that ESI may develop based on the Phase I evaluation results, as further described in Section 6.1 of the Main Body.

“SME” means subject matter expert.

“Solar PV” means solar photovoltaic, a form of technology involving systems that use solar cells to capture the sun rays and convert that energy into electricity.

“Special Considerations” means the specific term(s) set forth or described in the applicable Term Sheet identified by a Bidder to which such Bidder takes exception and provides a reasonably complete and detailed explanation of Bidder’s position in the “Special Considerations” section of its proposal.

“Term Sheet” means each of the term sheets in Appendix B-1 and B-2, which summarize some of the key commercial terms that would apply to PPAs and asset acquisition Transactions arising out of this RFP.

“Threshold Requirements” means the minimum requirements for proposals submitted into this RFP to advance to the next evaluation stage of this RFP, as described in Section 2.3 of the Main Body.

“Transaction” means a commercial transaction arising or resulting from this RFP in which Seller provides to Buyer Capacity, energy, Environmental Attributes (if any), and Other Electric Products from a specified resource and that is structured as a PPA or a purchase and sale of generating facilities.

“Viability Assessment Team” or “VAT” means the Evaluation Team responsible for assessing the viability of each Bidder proposal submitted in response to this RFP (as further described in Section 6.1.3 of the Main Body).

“Viability Assessment Threshold Requirements” means the Threshold Requirements described in Section 2.3.2 of the Main Body.

“VIE” means variable interest entity under the rules and standards of the FASB.

“Zonal Resource Credit” or “ZRC” has the meaning given to such term in the MISO Rules. For the avoidance of doubt, as of the date of this RFP, ZRCs include any ZRCs properly generated from Demand Response Resources (as defined in the MISO Rules) and/or Load Modifying Resources (as defined in the MISO Rules).

The statements contained in this Appendix A are made subject to the Reservation of Rights set forth in Appendix E of this RFP and the terms and acknowledgements set forth in the Proposal Submission Agreement.



***Appendix B-1***

***Term Sheet For PPAs***  
***For***  
***2016 Request For Proposals***  
***For***  
***Long-Term Renewable***  
***Generation Resources***  
***For***  
***Entergy New Orleans, Inc.***

Entergy Services, Inc.  
July 13, 2016

### Term Sheet for PPA Product

The following bid submission term sheet (this “**Term Sheet**”) describes certain terms and conditions of a potential agreement between Entergy New Orleans, Inc. (“**Buyer**” or “**ENOI**”), and the seller of power proposed by the applicable bidder (“**Bidder**”) in Bidder’s proposal submitted in the RFP (“**Seller**” and, together with Buyer (defined below), the “**Parties**”) for the purchase by Buyer of long-term energy, environmental attributes, capacity, capacity-related benefits, and other electric products from a run-of-river hydroelectric, solar photovoltaic (“**Solar PV**”), or onshore wind technology renewable resource capable of meeting the requirements of this product (the “**Facility**”) in connection with the RFP. The terms set forth in this Term Sheet will establish the basis for the negotiation and execution of a definitive agreement between Buyer and any Seller whose proposal is selected by Entergy Services, Inc. (“**ESI**”) for contract negotiations in connection with the RFP (the “**Definitive Agreement**”), with necessary changes to accurately reflect any special considerations set forth in Bidder’s proposal that are accepted by Buyer in its sole and absolute discretion. Buyer will provide the initial draft of the Definitive Agreement to the selected third-party Bidder (if any) at the beginning of contract negotiations.

If Bidder is unable or unwilling to accept one or more of the terms and conditions set forth in this Term Sheet or wishes to propose any alternate or additional terms or conditions (such as a buy-out option at some point during the term of the Definitive Agreement), Bidder should indicate in the “Special Considerations” section of its Proposal Package (i) the terms and conditions to which Bidder takes exception, describing with specificity any terms and conditions that Bidder proposes in substitution therefor, and/or (ii) the additional terms and conditions that Bidder proposes as a supplement to the terms and conditions in this Term Sheet. Bidder is advised to refer to Section 2.2 in the Main Body for additional information pertaining to Special Considerations.

	Proposal Term	Description of Proposal Term
1	<b>Product Description:</b>	<p>The product described in this Term Sheet is designated as the “<b>PPA Product.</b>” This product provides for generation capacity of (i) for any resource except a Solar PV resource, not less than 5 MW and not more than 20 MW of capacity from the Facility, (ii) for any Solar PV resource other than an Aggregated Solar PV Resource (defined below), not less than 1 MW and not more than 20 MW of capacity from the Facility, or (iii) for any Aggregated Solar PV Resource, not less than 1 MW (with no individual site less than 100 kW) and not more than 5 MW of capacity from the Facility. Buyer will be entitled to all energy, environmental attributes, capacity, capacity-related benefits, and other electric products from the Facility (or portion thereof allocated to Buyer).</p> <p>“<b>Aggregated Solar PV Resource</b>” means a resource comprised of two or more Solar PV facilities, with each such facility (i) located within the ENOI Load Zone, (ii) interconnected to the electric grid at a distribution voltage level (less than 69 kV), and (iii) having a capacity level of at least 100 kW.</p>

The statements contained in this Term Sheet are made subject to the Reservation of Rights set forth in Appendix E of the RFP and the terms and acknowledgements set forth in the Proposal Submission Agreement.

**Term Sheet for PPA Product**

<b>2</b>	<b>Buyer:</b>	Buyer is ENOI. For purposes of the RFP and the Definitive Agreement, Buyer will be considered an entity entirely separate and distinct from any Entergy transmission/distribution organization and, without limiting the foregoing, the acts and omissions of any Entergy transmission/distribution organization will not be deemed to be acts and omissions of Buyer for any purpose arising out of or relating to the RFP or the Definitive Agreement.
<b>3</b>	<b>Seller:</b>	“ <b>Seller</b> ” will be the party specified by Bidder in the applicable proposal.
<b>4</b>	<b>Facility:</b>	The “ <b>Facility</b> ,” including the nameplate capacity and major equipment, will be as specified by Bidder in the applicable proposal. For any proposal regarding an Aggregated Solar PV Resource, the term “Facility” as used in this Term Sheet will include all the facilities comprising the Aggregated Solar PV Resource.
<b>5</b>	<b>Physical Delivery Point; Electric Interconnection Point; Financial Settlement Point:</b>	<p>The “<b>Physical Delivery Point</b>” will be the electric interconnection point (or, for an Aggregated Solar PV Resource, points) and/or CP Node at which energy and other products contracted for by ENOI pursuant to the Definitive Agreement are physically delivered by Seller under the Definitive Agreement. If the Facility is or will be directly interconnected to the MISO System at a transmission voltage level (69 kV and higher) or the ENOI distribution system at a distribution voltage level, the Physical Delivery Point will be the Electric Interconnection Point (defined below). If the Facility is not or will not be directly interconnected to the MISO System at a transmission voltage level or the ENOI distribution system at a distribution voltage level, the Physical Delivery Point will be the point in MISO South at which energy and other products contracted for by ENOI from Seller pursuant to this RFP are physically delivered by Seller under the Definitive Agreement, which point is expected to be as specified by Bidder in the applicable proposal. (If the Facility is an Aggregated Solar PV Resource, the foregoing will apply with respect to each Physical Delivery Point.)</p> <p>The “<b>Electric Interconnection Point</b>” will be the point (or, for an Aggregated Solar PV Resource, points) where the Facility interconnects to the host utility (and, except if the Facility is interconnected at a distribution voltage level, is represented by a CP Node (the “<b>Interconnection CP Node</b>”)), which point is expected to be as specified by Bidder in the applicable proposal. (If the Facility is an Aggregated Solar PV Resource, the foregoing will apply with respect to each Electric Interconnection Point.)</p> <p>The “<b>Financial Settlement Point</b>” will be the CP Node for Buyer’s load (EES.NOPLD).</p> <p>For purposes of this Term Sheet, the term “<b>Entergy Transmission System</b>” means the interconnected group of transmission lines and substations that, as</p>

The statements contained in this Term Sheet are made subject to the Reservation of Rights set forth in Appendix E of the RFP and the terms and acknowledgements set forth in the Proposal Submission Agreement.

**Term Sheet for PPA Product**

		<p>of the date of this Term Sheet, are owned, leased, or controlled by ENOI and the other Entergy Operating Companies, each in its capacity as the owner and/or lessee of regulated transmission and distribution functions, and/or its successor(s) in such capacity, that are used to transfer bulk electricity between supply and delivery points, notwithstanding that there may be a Balancing Authority (including any regional transmission organization (“RTO”) or independent system operator (“ISO”)) applicable thereto that covers a system broader than such interconnected group of transmission lines and substations.</p>
<p><b>6</b></p>	<p><b>Electric Inter-connection;  Transmission/  Distribution;  ARRs and  FTRs:</b></p>	<p>Seller will be responsible for (and bear the full costs and risks of) the arrangement, procurement, receipt and maintenance prior to and throughout the Delivery Term of the interconnection, deliverability, and transmission/distribution service required for the Facility, including, without limitation, (i) the electric interconnection of the Facility to the host utility and establishment of the Electric Interconnection Point (including, as applicable, the Interconnection CP Node) and (ii) the injection of energy and other electric products at the Electric Interconnection Point, the transfer and delivery of energy, capacity, and other electric products to the Physical Delivery Point, and, if the Facility is interconnected at a transmission voltage level, the financial settlement of power delivered to or for Buyer under the Definitive Agreement at the Financial Settlement Point.</p> <p>Without limiting the foregoing, Seller will bear (a) all related interconnection, deliverability, or transmission/distribution request, application, study, registration, and comparable fees, charges, or costs, (b) all upgrade, improvement, and other fees, charges, and costs arising out of the requested interconnection, deliverability, or transmission/distribution service, except to the extent stated to be the exclusive responsibility and cost of the host utility or an applicable transmission/distribution service provider, transmission/distribution owner, or Balancing Authority under the applicable tariffs, rules, regulations, or requirements of, or generator interconnection or other agreements with, the host utility or such transmission/distribution service provider, transmission/distribution owner, or Balancing Authority, (c) all upgrade, improvement, and other fees, charges, and costs arising out of Buyer’s request for full network integration service for the energy delivered from the Facility (or portion thereof allocable to Buyer), (d) all fees, charges, and costs to receive interconnection, deliverability, transmission/distribution, and financial settlement service, (e) all transformer, line, energy, capacity, and other losses or costs related to the interconnection, deliverability, transmission/distribution, or financial settlement service with respect to the Facility (including, without limitation, any basis differential and associated costs between the Physical Delivery Point and the Financial Settlement Point with respect to any power delivered from the Facility (or portion thereof allocated to Buyer) at the Physical Delivery Point in accordance with the terms of the Definitive Agreement), and (f) all costs assigned or allocated to Seller</p>

The statements contained in this Term Sheet are made subject to the Reservation of Rights set forth in Appendix E of the RFP and the terms and acknowledgements set forth in the Proposal Submission Agreement.



**Term Sheet for PPA Product**

	<p>or to a financially settling party under the applicable tariffs, rules, regulations, or requirements of, or agreements with, the host utility, transmission/distribution service provider, transmission/distribution owner, or any applicable Balancing Authority.</p> <p>For the avoidance of doubt, if the Facility is or will be interconnected at a transmission voltage level, Seller is the Market Participant (as defined in item 15 below) and Seller is required to deliver energy and/or other electric products to Buyer over any settlement interval on an operating day pursuant to the terms of the Definitive Agreement, the Parties will reflect in the financial schedule (under the current MISO Rules, through designation of the Financial Settlement Point as both the Sink Point (as defined in the MISO Rules) and the Internal Delivery Point (as defined in the MISO Rules) and the Physical Delivery Point as the Source Point (as defined in the MISO Rules) in such financial schedule) or comparable documentation submitted to MISO or other applicable Balancing Authority(ies) for such settlement interval of such operating day any basis differential between the Physical Delivery Point and the Financial Settlement Point over such settlement interval of such operating day. If Seller is not the Market Participant or the Facility is interconnected at a transmission voltage level and registered as a Load Modifying Resource (as defined in the MISO Rules), the basis differential and associated costs will be reflected in the applicable monthly invoice covering the applicable settlement interval through a dollar-for-dollar adjustment for such settlement interval.</p> <p>As part of its responsibilities under this item 6, if the Facility is or will be directly interconnected to the MISO System at a transmission voltage level, Seller will be required to obtain and maintain throughout the Delivery Term energy resource interconnection service (“<b>ERIS</b>”) and network resource interconnection service (“<b>NRIS</b>”) from MISO as required herein under the MISO Tariff (or the most equivalent service in the event MISO discontinues or modifies the nature of ERIS or NRIS or both, as applicable, or, with respect to ERIS, is not the Balancing Authority in which the Facility is located) in a quantity (a) with respect to ERIS, equal to at least the amount of the capacity of the Facility (or, if applicable, the portion of the capacity allocated to Buyer) and (b) with respect to NRIS, (x) sufficient to allow the Facility to be eligible to receive the maximum capacity credits a resource of its capacity size can receive under the MISO Rules throughout the Delivery Term or (y) to be allocated and prioritized such that the NRIS level associated with the capacity of the Facility (or, if applicable, the portion of the capacity allocated to Buyer) under contract to Buyer cannot limit the amount of MISO capacity credits Buyer receives for any planning period during the Delivery Term.</p> <p>If the Facility is or will be interconnected at a transmission voltage level but is not or will not be directly interconnected to the MISO System, Seller will be required to obtain and maintain throughout the Delivery Term both</p>
--	--

The statements contained in this Term Sheet are made subject to the Reservation of Rights set forth in Appendix E of the RFP and the terms and acknowledgements set forth in the Proposal Submission Agreement.

**Term Sheet for PPA Product**

	<p>interconnection service and firm deliverability/transmission service from the Facility to the Physical Delivery Point in amount(s) sufficient to enable Seller to deliver the maximum amount of contract energy that Seller may deliver to the Physical Delivery Point under the Definitive Agreement.</p> <p>If the Facility is or will be interconnected at a transmission voltage level, without limiting Seller’s responsibilities set forth in this item 6, at a time deemed appropriate by Buyer after execution of the Definitive Agreement with Seller, Buyer will seek to qualify the Facility (or the portion thereof allocated to Buyer), or have the Facility (or the portion thereof allocated to Buyer) recognized, as a firm designated network resource of Buyer in the applicable Balancing Authority(ies) for the Delivery Term. Seller will be responsible and reimburse Buyer upon demand for all out-of-pocket costs incurred by Buyer in connection with Buyer obtaining, or attempting to obtain, such qualification or recognition, including, without limitation, with respect to Buyer’s obtaining full network integration service for the energy delivered from the Facility (or portion thereof allocable to Buyer).</p> <p>If the Facility is or will be interconnected at a transmission voltage level, subject to Buyer’s rights under item 15 below and any Buyer’s instruction to the contrary in whole or in part, Seller will, at its own expense, timely execute and file all documents and take all other actions necessary or advisable to cause (1) the Facility (or portion thereof allocated to Buyer) to be qualified and/or recognized by the applicable Balancing Authority(ies) as a firm designated network resource, for the Delivery Term in the applicable Balancing Authority(ies) and to maintain such status throughout the Delivery Term, (2) the Facility (or portion thereof allocated to Buyer) to be qualified and/or recognized by the applicable Balancing Authority(ies) as a firm designated network resource of Buyer, for the Delivery Term in the applicable Balancing Authority(ies) and to maintain such status throughout the Delivery Term, and (3) Buyer to obtain directly (or, if not possible for Buyer to obtain directly, Seller to obtain and transfer to Buyer, at and subject to Buyer’s direction) all Auction Revenue Right (as defined in the MISO Rules) (“<b>ARR</b>”), Financial Transmission Right (as defined in the MISO Rules) (“<b>FTR</b>”), and other similar entitlements and rights with respect to such firm designated network resource.</p> <p>Notwithstanding anything to the contrary, and without limiting item 11 below, all allocations of ARRs and, if applicable, FTRs and similar rights by any Balancing Authority(ies) applicable to the Physical Delivery Point or arising out of the Definitive Agreement that are associated with the energy, capacity, capacity-related benefits, and/or other electric products to be provided under the Definitive Agreement during the Delivery Term, including, for the avoidance of doubt, ARR and FTR allocations based on data, performance, or periods prior to the Delivery Term (or are associated with any transmission service or usage or physical, financial, or other transfer with respect to any of</p>
--	---

The statements contained in this Term Sheet are made subject to the Reservation of Rights set forth in Appendix E of the RFP and the terms and acknowledgements set forth in the Proposal Submission Agreement.

**Term Sheet for PPA Product**

		<p>the same), and all FTRs and other entitlements derived therefrom or otherwise related thereto, will exclusively and solely accrue to and be owned by Buyer, including after termination of the Definitive Agreement.</p> <p>Buyer will have the right to exercise, in its sole and absolute discretion, any and all rights with respect to any such entitlement or similar right, including the right to nominate (or not nominate) the same. Without limiting the foregoing, Seller will support fully, and not take any action or position to oppose, Buyer’s receipt of such firm designated network resource status or such allocations, entitlements, or rights or its exercise of its rights with respect thereto.</p> <p>If the Facility is or will be interconnected at a distribution voltage level, (i) Seller will be required to obtain and maintain throughout the Delivery Term distribution interconnection service from the Facility to the Physical Delivery Point in amount(s) sufficient to enable Seller to deliver the maximum amount of contract energy that Seller may deliver to the Physical Delivery Point under the Definitive Agreement, and (ii) subject to any Buyer’s instruction to the contrary in whole or in part, Seller will, at its own expense, timely execute and file all documents and take all other actions necessary or advisable to cause (1) the Facility (or portion thereof allocated to Buyer) to be qualified and/or recognized by MISO or other applicable Balancing Authority(ies) as a Load Modifying Resource or other form of distribution-level resource recognized by MISO or such other applicable Balancing Authority(ies) and to maintain such status throughout the Delivery Term and (2) Buyer to be eligible for and obtain directly (or, if not possible for Buyer to obtain directly, Seller to obtain and transfer to Buyer, at and subject to Buyer’s direction) all distribution entitlements and rights associated with the Facility (or portion thereof allocated to Buyer).</p>
7	<b>Distribution-Level Resources:</b>	<p>While this Term Sheet includes a number of terms that would apply if the Facility is or will be interconnected to the grid at a distribution voltage level, the Definitive Agreement may reflect additional provisions not included in this Term Sheet and/or provisions different from those set forth in this Term Sheet that apply to transmission-level resources, including, without limitation, those relating to the offering and settling of energy in the MISO energy markets.</p>
8	<b>Delivery Term:</b>	<p>The Delivery Term is expected to be as specified by Bidder in the applicable proposal. Subject to the final paragraph of this item 8, the Delivery Term will commence at the start of the hour ending 0100 BA Time on the first day of (i) the first month following the month in which the last of the conditions to the commencement of the Delivery Term (see item 27) has been satisfied or waived if notice of such satisfaction or waiver is provided by the satisfying or waiving party to the other on or before the first ten (10) days of such month or (ii) the second month following the month in which the last of the conditions to the commencement of the Delivery Term has been satisfied or waived if</p>

The statements contained in this Term Sheet are made subject to the Reservation of Rights set forth in Appendix E of the RFP and the terms and acknowledgements set forth in the Proposal Submission Agreement.

**Term Sheet for PPA Product**

		<p>notice of such satisfaction or waiver is provided by the satisfying or waiving party to the other after the first ten (10) days and before the end of such month. The Delivery Term will continue until the end of the hour ending 2400 BA Time on the day prior to the specified anniversary of such start date; <u>provided, however</u>, that if such anniversary day falls on a day other than the first day of the planning period for the applicable Balancing Authority, Buyer may elect, in its sole and absolute discretion, upon notice to Seller given at least one (1) year before the date on which, without such notice, the Delivery Term would expire, to have the Delivery Term continue until the last day of such planning period.</p> <p>Notwithstanding the foregoing, unless Buyer otherwise elects, the Delivery Term will not commence at the time it would otherwise commence if, at such time, (i) the Facility is experiencing an outage or other limitation, including a Force Majeure (as defined in item 22 below), that reduces the amount of the capacity allocated to Buyer that Seller could reasonably make available to Buyer at the Physical Delivery Point by ten percent (10%) or more below the capacity allocated to Buyer or (ii) there exists a default (or event or circumstance that with the passage of time or the giving of notice or both would constitute a default) of Seller under the Definitive Agreement.</p>
9	<b>Energy Price:</b>	<p>For each MWh of contract energy delivered from the Facility (or portion thereof allocated to Buyer) at the Physical Delivery Point in accordance with the terms of the Definitive Agreement, Buyer will pay the “<b>Energy Price</b>” for the applicable year of the Delivery Term (expressed in \$/MWh), which is expected to be the price specified by Bidder in the applicable proposal; <u>provided, however</u>, for any energy so delivered in excess of one hundred and fifteen percent (115%) of the Annual Expected Energy Quantity (defined below) in any contract year, the Energy Price shall be fifty percent (50%) of the otherwise applicable energy price.</p> <p>For purposes of this Term Sheet, the term “<b>Annual Expected Energy Quantity</b>” means the amount of energy Seller expects to deliver from the Facility (or portion thereof allocated to Buyer) in accordance with the Definitive Agreement at the Physical Delivery Point for a given contract year, which is expected to be the amount at which there is a fifty percent (50%) probability that the actual energy deliveries at the Physical Delivery Point for a given contract year will exceed such amount and a fifty percent (50%) probability that such actual energy deliveries will be less than such amount.</p> <p>The Energy Price described above is an all-in price and, accordingly, will be inclusive of all costs to Seller of generating, delivering, and/or providing energy, environmental attributes, capacity, capacity-related benefits (including any capacity credit or similar right or benefit), and other electric products to Buyer under the Definitive Agreement and all other costs that Bidder is proposing to pass through to Buyer, including, without limitation,</p>

The statements contained in this Term Sheet are made subject to the Reservation of Rights set forth in Appendix E of the RFP and the terms and acknowledgements set forth in the Proposal Submission Agreement.

**Term Sheet for PPA Product**

		<p>costs of cyclical, major, and other maintenance, adders and any applicable ancillary services, costs of licensing, permitting, and legal compliance (including future legal compliance), and costs of other Balancing Authority services, penalties, settlements, and other charges. The Energy Price should also take into account any tax credits and tax benefits associated with the Facility.</p> <p>Except to the extent otherwise expressly provided in this Term Sheet, Buyer will not be required to pay any amount to Seller other than the Energy Payment (equal to the Energy Price multiplied by the energy that is delivered from the Facility (or portion thereof allocated to Buyer) at the Physical Delivery Point in accordance with the terms of the Definitive Agreement, subject to adjustment to reflect the financial settlement of such deliveries at the Financial Settlement Point as provided herein).</p> <p>All payments will be monthly in arrears.</p>
10	<b>Capacity Allocated to Buyer:</b>	<p>The capacity of the Facility allocated to Buyer, expressed in MW (the “<b>Capacity Allocated to Buyer</b>”), is expected to be as specified by Bidder in the applicable proposal. In the event Bidder has proposed to allocate to Buyer the entire nameplate capacity of the Facility, at Buyer’s election, the Capacity Allocated to Buyer may be reflected in the Definitive Agreement as one hundred and five percent (105%) of such nameplate capacity to account for actual generation capabilities greater than such nameplate capacity. Other provisions will apply in the event Bidder has proposed to allocate to Buyer less than the entire capacity of the Facility to Buyer, including, without limitation, priority of the Facility’s capacity, allocation of capacity-related benefits (including capacity credits), and separate metering of energy.</p>
11	<b>Capacity-Related Benefits, Environmental Attributes, and Other Electric Products:</b>	<p>Buyer’s purchase of energy under the Definitive Agreement will include the purchase of all capacity-related benefits (including any capacity credit or similar right or benefit), environmental attributes, and other electric products associated with the Facility (or portion thereof allocated to Buyer) or its capacity, energy, or operation. The Energy Payment includes all compensation to Seller for such purchase, and no other or further amount will be payable by Buyer in connection with the acquisition, provision, or delivery of such capacity-related benefits, environmental attributes, and other electric products. Throughout the Delivery Term, Buyer will have the right to dispatch such products, and Seller will (at its own expense) generate and deliver to Buyer at the Physical Delivery Point, and, if the Facility is interconnected at a transmission voltage level, financially settle with Buyer at the Financial Settlement Point, any products so dispatched by or for Buyer. In the case of any such product that is not physical in nature (such as capacity credits and other intangible products), Seller will, without the requirement of any dispatch or other notice from Buyer and at Seller’s own expense, (i) cause to be issued any and all such products for which the Facility (or portion thereof allocated</p>

The statements contained in this Term Sheet are made subject to the Reservation of Rights set forth in Appendix E of the RFP and the terms and acknowledgements set forth in the Proposal Submission Agreement.

**Term Sheet for PPA Product**

	<p>to Buyer) is eligible and (ii) to the extent not issued directly to Buyer, obtain and transfer to Buyer custody of and title to (or, if not possible, the benefit of, as directed by Buyer) all such products.</p> <p>Without limiting the foregoing, Seller will (at its own expense) (a) timely execute and file all documents, including any applicable requests for qualification or registration of the Facility (or portion thereof allocated to Buyer) for or to provide (as applicable) each of such products for which it is eligible (including capacity credits and other capacity-related benefits), (b) take all other actions, including identifying and complying with any applicable certification procedures and operating requirements (including required testing and outage reporting), in all cases, necessary or advisable to register and qualify the Facility (or portion thereof allocated to Buyer) for or to provide (as applicable) all such products for which it is eligible and otherwise meet its obligations above, including, if applicable, for Buyer to be able to obtain and, if applicable (see item 15), schedule, offer, bid, and settle such products with the applicable Balancing Authority(ies) and (c) use commercially reasonable efforts to maximize any capacity credits and other capacity-related benefits for which the Facility (or portion thereof allocated to Buyer) is eligible.</p> <p>In the event any capacity credit or other capacity-related benefit is sourced from a resource not located within the Local Resource Zone (as defined in the MISO Rules) that includes Buyer's service territory (currently Local Resource Zone 9), (i) if the auction clearing price for such capacity credit or capacity-related benefit ("<b>Out-of-Zone ACP</b>") is greater than the auction clearing price for a capacity credit or capacity-related benefit sourced from a resource located within the Local Resource Zone that includes Buyer's service territory ("<b>In-Zone ACP</b>"), Buyer will pay Seller the positive difference between the Out-of-Zone ACP and the In-Zone ACP and (ii) if the In-Zone ACP is greater than the Out-of-Zone ACP, Seller will pay Buyer the positive difference between the In-Zone ACP and the Out-of-Zone ACP. In addition, Seller will be responsible for all charges and other costs assigned or allocated to Seller or Buyer or to a financially settling party under the applicable tariffs, rules, regulations, or requirements of, or agreements with, the host utility, transmission provider, transmission owner, or any applicable Balancing Authority with respect to the settlement or transfer any capacity credit or other capacity-related benefit pursuant to the Definitive Agreement.</p> <p>Without limiting the first paragraph of this item 11, Seller will be required to provide the Guaranteed Environmental Attributes (as defined below) to Buyer for each MW of Capacity Allocated to Buyer or each MWh of energy delivered to the Physical Delivery Point and financially settled with Buyer at the Financial Settlement Point throughout the Delivery Term (even if some of such energy in any settlement interval is serviced from the imbalance energy</p>
--	---

The statements contained in this Term Sheet are made subject to the Reservation of Rights set forth in Appendix E of the RFP and the terms and acknowledgements set forth in the Proposal Submission Agreement.

**Term Sheet for PPA Product**

		<p>market or any of such capacity or energy is produced by fossil fuel for any reason).</p> <p>To the extent Seller does not provide Buyer environmental attributes to satisfy its obligations pursuant to this item 11 for any MW of Capacity Allocated to Buyer or MWh of energy delivered to the Physical Delivery Point and financially settled with Buyer at the Financial Settlement Point (<i>e.g.</i>, because such MWh was serviced from the imbalance energy market or such MW or MWh is produced by fossil fuel for any reason or, in the case of the Guaranteed Environmental Attributes, because the applicable environmental attribute program is no longer an environmental attribute program for which the Facility (or portion thereof allocated to Buyer) or its capacity, energy, or operation is eligible), then Seller will satisfy such obligation by providing Replacement EAs (as defined below) for such MW or MWh. For any such environmental attribute (or Replacement EA) that Seller does not provide to Buyer (after using commercially reasonable efforts to provide such environmental attribute or Replacement EA), Seller will pay to Buyer an amount equal to the highest “alternative compliance payment” or equivalent concept or market value then in effect pursuant to the environmental attribute program for which such environmental attribute or Replacement EA would have qualified.</p> <p>“<b>Guaranteed Environmental Attributes</b>” are expected to be the environmental attributes for which the Facility (or portion thereof allocated to Buyer) would be eligible as of the date of the Definitive Agreement.</p> <p>“<b>Replacement EAs</b>” means, for any MW of Capacity Allocated to Buyer or MWh of energy, environmental attributes of equivalent or higher market and compliance/qualification value and of the same vintage as the environmental attributes for which, if such MW or MWh were generated by the Facility, such MW or MWh would be eligible.</p>
12	<b>Testing/ Required Data:</b>	<p>Without limiting item 11 above, to the extent Buyer is required by applicable laws (including Balancing Authority rules) to demonstrate the capability of, or otherwise test, the Facility (or portion thereof allocated to Buyer) for purposes of capacity qualification or for any other purpose (including to meet requirements imposed by Buyer’s participation in any reliability group or Balancing Authority (including any ISO or RTO) or in any marketplace administered by any Balancing Authority (including any ISO or RTO)), Seller will cause such tests to be performed (including any deliverability tests and capability tests) according to applicable requirements at Seller’s sole cost and expense. In such event, (i) in the event the Capacity Allocated to Buyer is the entire capacity of the Facility, Buyer will purchase the power delivered from the Facility at the Physical Delivery Point according to such tests and (ii) in the event the Capacity Allocated to Buyer is less than the entire capacity of the Facility, Buyer will not be obligated, but will have the option, to purchase the</p>

The statements contained in this Term Sheet are made subject to the Reservation of Rights set forth in Appendix E of the RFP and the terms and acknowledgements set forth in the Proposal Submission Agreement.

**Term Sheet for PPA Product**

		<p>power delivered from the Facility at the Physical Delivery Point according to such tests.</p> <p>Seller will provide to Buyer (in the form and time frame reasonably requested by Buyer) all data and other information relating to the Facility, or the delivery of energy, environmental attributes, capacity, capacity-related benefits, and other electric products under the Definitive Agreement, necessary or advisable for Buyer to (i) participate fully in any markets (including any marketplace administered by any Balancing Authority) in which Buyer is participating or otherwise realize the benefits of the energy, environmental attributes, capacity, capacity-related benefits, and other electric products provided under the Definitive Agreement and (ii) otherwise comply with applicable laws or its obligations (including those set forth in item 6 above) or exercise its rights (including those set forth in item 15 below) under the Definitive Agreement, including, if Seller is the Market Participant, by providing Buyer with unrestricted “view” access to the MISO web portal for the Facility or portion thereof allocated to Buyer (or if unrestricted “view” access is no longer recognized in such portal, the most equivalent access then available in such portal). In addition, to the extent that, in Buyer’s good faith judgment, any of the matters described in clauses (i) or (ii) of the preceding sentence require modification or amendment of the Definitive Agreement or the development or implementation of, or agreement upon, protocols, procedures, processes, or terms and Buyer so requests, the Parties will make such modifications or amendments, and/or will develop, agree upon, and implement such protocols, procedures, processes, or terms, as expeditiously as practicable.</p>
13	<b>Delivery/Receipt Commitment:</b>	<p>Subject to item 19, Seller will be required to provide, sell, and deliver to Buyer, and Buyer will be required to purchase and accept from Seller, all energy generated by the Facility (or portion thereof allocated to Buyer) delivered to the Physical Delivery Point in accordance with the Definitive Agreement during the Delivery Term; <u>provided, however</u>, that in no event will Buyer be obligated to purchase and accept a quantity of energy in any hour in excess of the Capacity Allocated to Buyer, multiplied by one (1) hour.</p>
14	<b>Deliveries; Exclusivity:</b>	<p>Seller will make available to Buyer all capacity of the Facility (or portion thereof allocated to Buyer) and will deliver to Buyer all associated energy, environmental attributes, capacity-related benefits, and other electric products from the Facility at the Physical Delivery Point and, if the Facility is interconnected at a transmission voltage level, financially settle with Buyer at the Financial Settlement Point in accordance with the requirements of the Definitive Agreement (including the applicable Buyer’s Delivery Directive (defined in item 15 below) or Buyer’s generation notices, as applicable). Except to the extent required by a unit contingency or according to a curtailment or Buyer’s Delivery Directive, Seller will not interrupt, curtail, or otherwise reduce the availability or deliveries of the Capacity Allocated to</p>

The statements contained in this Term Sheet are made subject to the Reservation of Rights set forth in Appendix E of the RFP and the terms and acknowledgements set forth in the Proposal Submission Agreement.



**Term Sheet for PPA Product**

		<p>Buyer or any associated energy, environmental attribute, capacity-related benefit, or other electric product, even if Seller is above the Annual Guaranteed Energy Quantity.</p> <p>Buyer’s rights to the energy, environmental attributes, capacity, capacity-related benefits, and other electric products from the Facility (or portion thereof allocated to Buyer) are exclusive, and, except with respect to Buyer-Curtailed Energy and any other limited exceptions expressly set forth in the Definitive Agreement, Seller may not offer, sell, deliver, or make available for any delivery period during the Delivery Term any of such energy, environmental attributes, capacity, capacity-related benefits, or other electric products for the benefit of any person other than Buyer.</p>
15	<p><b>Market Functions and Revenues:</b></p>	<p>Subject to certain limitations, throughout the term of the Definitive Agreement, Buyer will have the right to determine from time to time whether Buyer (or a designee of Buyer) or Seller will serve as the market participant or other representative for the Facility (or the portion thereof allocated to Buyer) before MISO or, in the event Buyer is not subject to the MISO Balancing Authority, the largest Balancing Authority to which Buyer is then subject with respect to any planning period of MISO or such other Balancing Authority during the Delivery Term (“<b>Market Participant</b>”). As of the date of this Term Sheet, Buyer’s preference is (i) for Seller to serve initially as the Market Participant during the Delivery Term if the Facility will be registered with MISO as a Capacity Resource (defined below) and (ii) for Buyer to serve initially as the Market Participant during the Delivery Term if the Facility will not be registered as a Capacity Resource (<i>e.g.</i>, as a Load Modifying Resource). In the event Buyer elects to replace Seller as Market Participant, Seller will provide any service that, pursuant to MISO Rules, may only be performed by the party acting as Market Participant with respect to the period during which Seller served as Market Participant (<i>e.g.</i>, services involving adjustments to determinations of the generation output of the Facility, or that results from or arises out of the performance of such service, <i>e.g.</i>, related billing adjustments, reconciliations, and settlements under the Definitive Agreement). If the Facility is not registered as a Capacity Resource and Buyer elects to serve as the Market Participant, Seller will be required to cooperate with Buyer to ensure that the registration and any qualification of the resource in MISO is made in accordance with MISO Rules and Buyer’s reasonable requirements, including, without limitation, with regard to generator availability forecasting.</p> <p>For purposes of this Term Sheet, the term “<b>Capacity Resource</b>” means any Generation Resource, Dispatchable Intermittent Resource, External Resource, or Intermittent Generation that is available to meet Demand (as each such capitalized term is defined in the MISO Rules). For the avoidance of doubt, “Capacity Resource” does not include any Load Modifying Resource.</p>

The statements contained in this Term Sheet are made subject to the Reservation of Rights set forth in Appendix E of the RFP and the terms and acknowledgements set forth in the Proposal Submission Agreement.

### Term Sheet for PPA Product

	<p>Buyer will be entitled to (and, to the extent required by the rules, procedures, and protocols of the applicable Balancing Authority or other applicable laws, Buyer will), on an exclusive basis, select the type of resource designation(s) that would apply to the Facility or portion thereof allocated to Buyer (e.g., intermittent resource, capacity resource, load-modifying resource or behind-the-meter generator, or other type of resource recognized by the applicable Balancing Authority) in such Balancing Authority(ies) and register, or cause the registration of, the Facility in the MISO Commercial Model (or similar commercial model in the applicable Balancing Authority), provided that any such resource designation is a designation for which the Facility is eligible and the Facility is eligible for such registration and the decision to so register the Facility can be made by Seller or the Market Participant pursuant to MISO Rules (or the rules of the applicable Balancing Authority), in Buyer's good faith judgment, at the time Buyer selects such designation or elects such registration.</p> <p>If Seller is the Market Participant and the Facility is registered as a Capacity Resource, the following provisions will apply at such time during the Delivery Term:</p> <ul style="list-style-type: none"><li>• Seller or Seller's agent will (1) schedule, offer and/or bid, on an exclusive basis, the energy, environmental attributes, capacity, capacity-related benefits, and other electric products from the Facility (or portion thereof allocated to Buyer) with the applicable Balancing Authority at the Physical Delivery Point, subject to the terms of the Definitive Agreement, and (2) settle any such schedules, offers and/or bids with such Balancing Authority, subject to re-allocation of associated amounts, if applicable, according to the Definitive Agreement.</li><li>• Subject to item 19, in respect of each settlement interval, Buyer will provide to Seller, by electronic mail or other electronic transmission acceptable to Seller in its reasonable discretion, the Buyer's Delivery Directive (defined below) at least two (2) hours before the applicable deadline for submitting schedules or offers to the applicable Balancing Authority for such settlement interval ("<b>Directive Deadline</b>").</li><li>• If Seller receives a Buyer's Delivery Directive by the Directive Deadline, Seller will schedule, offer and/or bid the products with such Balancing Authority such that the offer or bid price for a given settlement interval is equal to the Minimum Settlement Price (defined below) for such settlement interval set forth in such Buyer's Delivery Directive.</li></ul> <p>If Seller is to serve as the Market Participant, Seller will cause MISO (or such other applicable Balancing Authority) to qualify and recognize Seller as the exclusive Market Participant as of the start of the Delivery Term (or such later date as specified by Buyer) and maintain such qualification and recognition</p>
--	---

The statements contained in this Term Sheet are made subject to the Reservation of Rights set forth in Appendix E of the RFP and the terms and acknowledgements set forth in the Proposal Submission Agreement.

**Term Sheet for PPA Product**

	<p>throughout the remainder of the Delivery Term (or the period(s) specified by Buyer).</p> <p>For purposes of this Term Sheet, “<b>Buyer’s Delivery Directive</b>” means, in respect of each settlement interval for a given operating day, a written notice from Buyer to Seller setting forth the Minimum Settlement Price and any limits on the amount of the energy and other electric products for such settlement interval that Buyer is willing to take delivery of pursuant to the Definitive Agreement.</p> <p>For purposes of this Term Sheet, “<b>Minimum Settlement Price</b>” means the price or prices, which may be included in a price curve, that Buyer provides in any Buyer’s Delivery Directive indicating the minimum LMP at the Financial Settlement Point for the relevant hour(s) and day(s) for the MISO Day-Ahead Energy Market or MISO Real-Time Energy Market, as applicable, at which Buyer is willing to take delivery of energy pursuant to the terms of the Definitive Agreement.</p> <p>If Buyer is the Market Participant and the Facility is registered as a Capacity Resource, the following provisions will apply at such time during the Delivery Term:</p> <ul style="list-style-type: none"><li>• Subject to the bullet point below, Buyer will (1) to the extent permitted or required by the applicable Balancing Authority, schedule, offer, and/or bid, on an exclusive basis, the energy, environmental attributes, capacity, capacity-related benefits, and other electric products from the Facility (or portion thereof allocated to Buyer) with such Balancing Authority at the Physical Delivery Point in its sole and absolute discretion and (2) settle any such schedules, offers, and/or bids with such Balancing Authority, subject to re-allocation of associated amounts, if applicable, according to the Definitive Agreement.</li><li>• Buyer may submit one or more schedules, offers, and/or bids with respect to each settlement interval, provided that the Balancing Authority requirement of the Facility to generate energy for any settlement interval as a result of Buyer’s schedules, offers, and/or bids equals the maximum amount of capacity available to Buyer based on the applicable generation forecast for the applicable settlement interval as set forth in the Definitive Agreement, subject to certain adjustments, including for Buyer-Curtailed Energy.</li><li>• Seller will continue to perform all other functions with respect to the Facility (and the provision and/or delivery of energy, environmental attributes, capacity, capacity-related benefits, and other electric products) before each applicable Balancing Authority, including, to the extent applicable, transmitting to the applicable Balancing Authority operational data or information (including derating and outage notices) and coordinating</li></ul>
--	--

The statements contained in this Term Sheet are made subject to the Reservation of Rights set forth in Appendix E of the RFP and the terms and acknowledgements set forth in the Proposal Submission Agreement.

**Term Sheet for PPA Product**

	<p>outages; <u>provided</u>, <u>however</u>, that, to the extent that, under applicable Balancing Authority rules, procedures, protocols, and other laws, such functions cannot be performed by a different person than the person that performs the functions described in the bullet points above, Buyer will perform such functions at Seller's expense and with full release and indemnification from Seller.</p> <p>If Buyer is to serve as the Market Participant, Seller will cause MISO (or such other applicable Balancing Authority) to (A) qualify and recognize Buyer or its designee as the exclusive Market Participant as of the start of the Delivery Term (or such later date as of which such concept is applicable or Buyer has specified to Seller) and maintain such qualification and recognition throughout the remainder of the Delivery Term (or the period(s) specified by Buyer) and (B) terminate such qualification and recognition as of the end of the Delivery Term, except to the extent required for transactions under the Definitive Agreement occurring prior to the end of the Delivery Term.</p> <p>If the Facility is interconnected at a transmission voltage level, Seller will ensure that at all times the Balancing Authority(ies) applicable to the Physical Delivery Point recognize the Facility (or portion thereof allocated to Buyer) as a separate generating resource and the Physical Delivery Point as a separate CP Node for settlement purposes (including that such Balancing Authority(ies) determine separately for settlement purposes the amount of energy actually delivered specifically from the Facility (or portion thereof allocated to Buyer) to the Physical Delivery Point and, if applicable, recognize the Facility (or portion thereof allocated to Buyer) as a separate generating resource for scheduling, offering, and bidding purposes). Seller will keep Buyer reasonably apprised of the progress and will obtain Buyer's approval (not to be unreasonably withheld, conditioned, or delayed) prior to entering into (or modifying) such arrangements.</p> <p>Except as the parties may otherwise agree, and subject to the financial settlement of products delivered pursuant to the terms of the Definitive Agreement at the Financial Settlement Point, Buyer will be entitled to (i) all payments and credits from any Balancing Authority or other person for (and will be responsible for any settlement at negative prices of) the energy, environmental attributes, capacity, capacity-related benefits, and other electric products provided under the Definitive Agreement during the Delivery Term and (ii) all other payments and credits from any applicable Balancing Authority in respect of the Facility or portion thereof allocated to Buyer (including the curtailment thereof). If Seller receives any such payment or credit due Buyer, Seller will promptly pay (or cause to be paid) to Buyer all amounts so received. In addition, Seller will pay to Buyer any shortfall in the payments or credits received for or relating to the energy, environmental attributes, capacity and capacity-related benefits, and other electric products</p>
--	--

The statements contained in this Term Sheet are made subject to the Reservation of Rights set forth in Appendix E of the RFP and the terms and acknowledgements set forth in the Proposal Submission Agreement.

**Term Sheet for PPA Product**

		<p>provided under the Definitive Agreement, to the extent resulting from Seller’s breach of the Definitive Agreement. For the avoidance of doubt, as used in this paragraph, the terms “payment” and “credit” do not include any “payment” or “credit” at negative prices or other amount that is effectively a charge; such amounts are addressed expressly in the parenthetical to clause (i) above and elsewhere in this Term Sheet (including item 20 below). Further, clause (i) of this paragraph does not include settlement at negative prices of, and other Imbalance Charges (as defined in item 20 below) for, positive imbalance energy, which settlement and other Imbalance Charges will be allocated between the Parties according to item 20 below.</p> <p>If Seller is the Market Participant, Seller will, at Buyer’s reasonable direction and expense for direct, out-of-pocket costs reasonably incurred by Seller and approved in advance by Buyer, dispute, settle, appeal, or otherwise challenge before MISO or other applicable Balancing Authority any cost, charge, payment, credit, or computation thereof by such Balancing Authority to the extent such cost, charge, payment, credit, or computation (i) is relevant to payments from such Balancing Authority or other credits to which Buyer is entitled or costs or charges paid by or invoiced to Buyer under the Definitive Agreement and (ii) as between the Parties, may be disputed only by Seller (or an agent or other representative of Seller in its capacity as such).</p>
<p><b>16</b></p>	<p><b>Financial Schedules:</b></p>	<p><i>{If the Facility is registered as a Capacity Resource}</i> Throughout the Delivery Term while Seller is serving as the Market Participant, with respect to each settlement interval, Seller shall, at its sole cost and expense and to the extent available under applicable laws (including MISO Rules), create and submit to the applicable Balancing Authority one or more “financial schedules” from Seller to Buyer covering such settlement interval (or equivalent concept in such Balancing Authority that causes such Balancing Authority to charge to Seller and pay to Buyer the price of the energy and other electric products delivered during such settlement interval and assign transmission losses and congestion risk from the Physical Delivery Point to the Financial Settlement Point to Seller) (each, a “<b>Financial Schedule</b>”) as described in this item 16.</p> <p>Seller and Buyer shall work together using commercially reasonable efforts to provide the necessary documentation to the applicable Balancing Authority to facilitate the processing of Financial Schedules. Subject to the terms set forth in this item 16, each Financial Schedule shall: (i) reflect the amount of energy actually or deemed delivered to Buyer under the Definitive Agreement and the amount of MISO Curtailed Energy (defined below) (collectively, “<b>Delivered Energy</b>”) that cleared the MISO Day-Ahead Energy Market or the MISO Real-Time Energy Market during the applicable settlement interval, as applicable, as determined pursuant to the paragraph below; (ii) designate the Physical Delivery Point as the Source Point (as defined in the MISO Rules); (iii) designate the Financial Settlement Point as both the Internal Delivery</p>

The statements contained in this Term Sheet are made subject to the Reservation of Rights set forth in Appendix E of the RFP and the terms and acknowledgements set forth in the Proposal Submission Agreement.

**Term Sheet for PPA Product**

	<p>Point (as defined in the MISO Rules) and the Sink Point (as defined in the MISO Rules); and (iv) otherwise meet the requirements for an accurate, complete and valid Financial Schedule in the applicable Balancing Authority.</p> <p>Except as set forth in the paragraph below, for each hour of each operating day, the Financial Schedule settlements shall be based on real-time MISO Financial Schedules and/or day-ahead MISO Financial Schedules as follows: (a) first, if the LMP at the Financial Settlement Point for a given operating hour in the MISO Day-Ahead Energy Market and the MISO Real-Time Energy Market is equal to or greater than the Minimum Settlement Price in the applicable Buyer's Delivery Directive, the settlement for such hour shall be pursuant to a day-ahead Financial Schedule with respect to such operating day and reflect the quantity of Delivered Energy during such hour or, if any quantity limitations are set forth in such Buyer's Delivery Directive, such lesser amount consistent with Buyer's Delivery Directive, and (b) second, to the extent any Delivered Energy is not accounted for pursuant to clause (a) above and the LMP at the Financial Settlement Point for a given operating hour in the MISO Real-Time Energy Market is equal to or greater than the Minimum Settlement Price in the applicable Buyer's Delivery Directive, the settlement for such hour shall be pursuant to a real-time Financial Schedule with respect to such operating day and reflect the quantity of such Delivered Energy.</p> <p>In the event that the LMP at both the Physical Delivery Point and the Financial Settlement Point for a given operating hour in the MISO Day-Ahead Energy Market is equal to or greater than the Minimum Settlement Price in the applicable Buyer's Delivery Directive, but the LMP at the Physical Delivery Point for such operating hour in the MISO Real-Time Energy Market is less than the Minimum Settlement Price in the applicable Buyer's Delivery Directive, the settlement for such hour shall be pursuant to (1) a day-ahead Financial Schedule with respect to the quantity of Delivered Energy during such hour, and (2) a real-time Financial Schedule with respect to the MISO Curtailed Energy, if any, during such hour, with such real-time Financial Schedule structured such that Buyer receives the credit or payment from MISO for such MISO Curtailed Energy that Seller, as Market Participant, would otherwise receive from MISO for such MISO Curtailed Energy.</p> <p>For purposes of this Term Sheet, "<b>MISO Curtailed Energy</b>" means energy that could have been delivered by the Facility to the Physical Delivery Point during a given settlement interval but was not delivered because or when the LMP at the Physical Delivery Point for such settlement interval in the MISO Real-Time Energy Market was less than the Minimum Settlement Price.</p> <p>Examples illustrating the operation of the Financial Schedule provisions described in this item 16 are provided in <u>Attachment A to this Term Sheet</u>.</p>
--	---

The statements contained in this Term Sheet are made subject to the Reservation of Rights set forth in Appendix E of the RFP and the terms and acknowledgements set forth in the Proposal Submission Agreement.

**Term Sheet for PPA Product**

<b>17</b>	<b>Minimum Energy Delivery Requirement:</b>	<p>Seller will be required to deliver energy pursuant to and in accordance with the Definitive Agreement at the Physical Delivery Point in an amount at or above the Annual Guaranteed Energy Quantity (defined below) in any contract year of the Delivery Term.</p> <p>For purposes of this Term Sheet, the “<b>Annual Guaranteed Energy Quantity</b>” means the amount of energy Seller guarantees it will deliver from the Facility (or portion thereof allocated to Buyer) at the Physical Delivery Point in accordance with the terms of the Definitive Agreement for a given contract year. The Annual Guaranteed Energy Quantity is expected to be established based on the technology utilized and/or the Annual Guaranteed Energy Quantity for a given contract year specified by Bidder in the proposal selected for negotiation of the Definitive Agreement. For all resources, the Annual Guaranteed Energy Quantity is expected to be at least the amount at which there is a ninety percent (90%) probability that the actual energy deliveries at the Physical Delivery Point for a given contract year will exceed such guaranteed amount and a ten percent (10%) probability that such actual energy deliveries will be less than such guaranteed amount. The Annual Guaranteed Energy Quantity for a given contract year will be subject to adjustment for Force Majeure and Buyer-Curtailed Energy (see items 22 and 19 below) in such contract year. Energy supplied from or to the imbalance market will not be considered energy delivered from the Facility (or portion thereof allocated to Buyer) at the Physical Delivery Point in accordance with the terms of the Definitive Agreement for purposes of determining satisfaction of Seller’s Annual Guaranteed Energy Quantity commitment. In the event of a shortfall in annual energy deliveries below the applicable Annual Guaranteed Energy Quantity, Seller will, among other things, pay liquidated damages to Buyer and, as described in item 11 above, transfer to Buyer or pay Buyer for the environmental attributes that Seller would have been obligated to transfer to Buyer if the energy shortfall had actually been generated by the Facility and delivered at the Physical Delivery Point. The failure of Seller to deliver energy from the Facility (or portion thereof allocated to Buyer) at the Physical Delivery Point in accordance with the terms of the Definitive Agreement in an amount equal to at least (a) eighty percent (80%) of the Annual Guaranteed Energy Quantity in any two consecutive contract years (“<b>Minimum Two Consecutive Contract Year Energy Quantity</b>”) or (b) seventy-five percent (75%) of the Annual Guaranteed Energy Quantity in any three contract years (“<b>Minimum Three Contract Year Energy Quantity</b>”) will be an event of default of Seller that would, among other things, entitle Buyer to terminate the PPA and receive termination damages. The Minimum Two Consecutive Contract Year Energy Quantity and the Minimum Three Contract Year Energy Quantity may be higher than eighty percent (80%) and seventy-five percent (75%), respectively, based on the probability distribution of annual generation</p>
-----------	---	---

The statements contained in this Term Sheet are made subject to the Reservation of Rights set forth in Appendix E of the RFP and the terms and acknowledgements set forth in the Proposal Submission Agreement.

**Term Sheet for PPA Product**

		output for a given resource, including, without limitation, considering such resource’s generation technology.
<b>18</b>	<b>Generation Forecasts:</b>	Seller will cause a reputable third-party forecaster to provide to Buyer (at Seller’s expense), in good faith and in accordance with accepted electrical practices, generation forecasts for the Facility (or portion thereof allocated to Buyer) for each day by the day-ahead generation forecast deadline specified in the Definitive Agreement for such day and updates thereto. In the event that any third-party forecaster is not providing forecasts in accordance with accepted electrical practices, then, upon receipt of written request from Buyer, Seller will, as soon as practicable, replace such third-party forecaster with another reputable third-party forecaster mutually agreeable to the Parties.
<b>19</b>	<b>Buyer-Curtailed Energy:</b>	<p>Buyer will have the right, in its sole and absolute discretion, to curtail some or all of the energy that would otherwise be energy delivered from the Facility at the Physical Delivery Point and, if the Facility is interconnected at a transmission voltage level, financially settled with Buyer at the Financial Settlement Point for any operating hour.</p> <p>Buyer can exercise such right by providing Seller notice of such curtailment (including pursuant to any Buyer’s Delivery Directive). In the case where Seller is the Market Participant and the Facility is registered as a Capacity Resource, if both the MISO Day-Ahead Energy Market and the MISO Real-Time Energy Market clear at the Financial Settlement Point with an LMP for any such operating hour below the applicable Minimum Settlement Price set forth in Buyer’s Delivery Directive, Buyer will be deemed to have curtailed any energy actually generated or, as further described below, that would have been generated by the Facility and delivered at the Physical Delivery Point under the Definitive Agreement during such operating hour.</p> <p>If Buyer exercises such curtailment rights, then, for any settlement interval for which Buyer has exercised such rights, Seller will provide to Buyer a calculation (which will be subject to audit and dispute by Buyer) determined in accordance with accepted electrical practices taking into account generator output data from reference generator units and data from the Facility’s SCADA system, including meteorological and other measurements, of the quantity of energy that would have been but was not generated by the Facility and delivered at the Physical Delivery Point during such interval due solely to Buyer’s exercise of its curtailment rights (the “<b>Buyer-Curtailed Energy</b>”).</p> <p>For each MWh of Buyer-Curtailed Energy, Buyer shall pay to Seller (i) the Energy Price that would have been applicable to such Buyer-Curtailed Energy, minus (ii) either (A) if, using commercially reasonable efforts consistent with the Facility’s operational characteristics and to the extent not prohibited under applicable law, Seller could re-sell such Buyer-Curtailed Energy to another purchaser (including MISO or other applicable Balancing Authority) for a</p>

The statements contained in this Term Sheet are made subject to the Reservation of Rights set forth in Appendix E of the RFP and the terms and acknowledgements set forth in the Proposal Submission Agreement.



**Term Sheet for PPA Product**

		<p>price that exceeds the amount in clause (B) below and Buyer does not expressly direct Seller not to re-sell such Buyer-Curtailed Energy, the price obtained by Seller by re-selling such Buyer-Curtailed Energy (or that would have been obtained by Seller had it used commercially reasonable efforts to re-sell such Buyer-Curtailed Energy) or (B) otherwise, the net costs saved by Seller (expressed in \$/MWh) as a result of not generating such Buyer-Curtailed Energy (or that would have been saved by Seller if, by using commercially reasonable efforts to maximize its net cost savings, it had not generated such Buyer-Curtailed Energy), the calculation of such net cost savings (determined in accordance with accepted electrical practices) to be provided by Seller to Buyer and subject to audit and dispute by Buyer, minus (iii) if applicable, the amount of the federal production tax credits or other similar generation-based credits, payments or benefits for which Seller would otherwise be eligible to receive if such Buyer-Curtailed Energy were actually generated (expressed in \$/MWh); <u>provided, however</u>, that, the amount determined pursuant to clause (ii) above may not be less than zero (0) as a result of the sale of any such Buyer-Curtailed Energy at negative prices or otherwise (and Buyer will not otherwise be responsible for any such negative amounts if Seller incurs them).</p> <p>Reliability curtailments (that is, curtailments made, initiated, directed, or ordered by an entity other than Buyer (<i>e.g.</i>, MISO or a local Balancing Authority) or other curtailments, limitations, or shortcomings (including emergency and scheduled or unscheduled outages, maintenance, or otherwise)) will not give rise to Buyer-Curtailed Energy.</p> <p>Seller will receive credit toward the Annual Guaranteed Energy Quantity for any Buyer-Curtailed Energy.</p>
20	<p><b>Operation and Maintenance Costs/ Imbalances:</b></p>	<p>Without limiting Buyer’s Energy Payment obligations provided in this Term Sheet, and except to the extent otherwise expressly provided in this Term Sheet, as between the Parties, Seller will bear all costs and expenses, of any kind or character, whether now in effect or at any time in the future coming into effect, arising out of or in connection with (i) the ownership, leasing, financing, insuring, development, engineering, procurement of equipment for, design, construction, installation, operation, maintenance, management, replacement, repair, studying, testing, or other use of the Facility (or any part thereof), including the real property interests related thereto, (ii) the conduct of business by Seller, (iii) Seller’s or Buyer’s functions pursuant to item 15 above, or (iv) the provision or delivery (or scheduling, offering, and bidding into the applicable Balancing Authority) of energy, environmental attributes, capacity, capacity-related benefits, and other electric products, or the performance of Seller’s other obligations, under the Definitive Agreement (collectively, the “<b>Seller Cost Scope</b>”), including, without limitation:</p>

The statements contained in this Term Sheet are made subject to the Reservation of Rights set forth in Appendix E of the RFP and the terms and acknowledgements set forth in the Proposal Submission Agreement.

**Term Sheet for PPA Product**

	<ul style="list-style-type: none"> <li>• any Balancing Authority (including applicable RTO or ISO) or other transmission provider membership, transaction, or other fees, costs, or charges, including costs and charges associated with (a) any schedule, offer, or bid made at the Physical Delivery Point pursuant to item 15 above, (b) any settlement with respect to or arising out of any such schedule, offer, or bid, including settlement through Financial Schedules or similar financial arrangements or transfers to the Financial Settlement Point for the purpose of settlement between Buyer and Seller or Buyer and any applicable Balancing Authority, or (c) otherwise with Seller’s or Buyer’s functions pursuant to item 15 above;</li> <li>• any penalties, fees, assessments, or other costs or charges for failure to satisfy any policy, rule, guideline, procedure, protocol, standard, criterion, or requirement of any market monitor, independent coordinator of transmission, Balancing Authority (including any applicable RTO or ISO), or other transmission provider (“<b>BA Penalties</b>”), including any penalties, fees, reductions in payment, assessments, or other costs, debits, or charges arising out of (1) any mitigation action taken by, any disallowance by, or other limitation on the recovery or payment of a cost, charge, expense, or credit imposed by any market monitor or MISO in connection with such failure or (2) any failure to meet operational directives, instructions, or requirements of MISO or other applicable Balancing Authority (including imbalance penalties);</li> <li>• electric imbalance charges and penalties (including any revenue sufficiency guarantee and similar charges, the cost of purchasing imbalance or real-time energy to settle under-generated energy and the cost of settlement at negative prices of over-generated energy), integration charges, the cost of any ancillary services and other Balancing Authority (including any applicable RTO or ISO) or other transmission provider services (including regulation, operating reserve, transmission study and upgrade costs, transmission congestion costs, transmission losses, and other transmission service costs) (“<b>Imbalance Charges</b>”); and</li> <li>• similar fees, costs, and charges arising out of or in connection with the Seller Cost Scope, regardless of whether imposed or assessed against Seller or Buyer (including in its role pursuant to item 15 above).</li> </ul> <p>Notwithstanding the foregoing, if Buyer is the Market Participant, Buyer will be responsible for (i) Imbalance Charges and BA Penalties incurred by Seller solely as a result of compliance by Seller with a generation notice issued by Buyer that requires Seller to violate (A) a directive or other instruction communicated by the Balancing Authority to Buyer in its role as Market Participant that has not been communicated to Seller or (B) a Balancing Authority requirement to generate (or not generate) a product expressly scheduled, offered and/or bid by Buyer pursuant to the Definitive Agreement</p>
--	--

The statements contained in this Term Sheet are made subject to the Reservation of Rights set forth in Appendix E of the RFP and the terms and acknowledgements set forth in the Proposal Submission Agreement.

**Term Sheet for PPA Product**

		<p>that is triggered solely by Buyer’s schedules, offers and/or bids, and (ii) except to the extent arising out of, in connection with, or resulting from a unit contingency or other outage or act or omission of Seller or its affiliates or its subcontractors or any of their respective agents or representatives, BA Penalties incurred by Seller solely as a result of Buyer scheduling, offering and/or bidding the capacity-related benefits, environmental attributes, energy and other electric products during the Delivery Term in a manner that violates Balancing Authority requirements.</p>
<p><b>21</b></p>	<p><b>Planned Maintenance:</b></p>	<p>“<b>Planned Maintenance</b>” means maintenance of the Facility (or portion thereof allocated to Buyer) that is scheduled in advance with Buyer in accordance with the terms of the Definitive Agreement and included in an agreed Planned Maintenance schedule and has a predetermined start date and expected duration (<i>e.g.</i>, inspections, testing).</p> <p>All maintenance of the Facility (or any portion thereof) that has a pre-determined start date and duration and includes a reduction in the availability of the Capacity Allocated to Buyer is required to be coordinated and scheduled in accordance with the Definitive Agreement as Planned Maintenance. For resources other than Solar PV, Seller will have the right to schedule and conduct Planned Maintenance only during the months of March and April and the months of October and November and otherwise in accordance with the terms of the Definitive Agreement. For Solar PV resources, Seller will have the right to schedule and conduct Planned Maintenance only during (i) times that do not occur during a daylight period (beginning sixty (60) minutes prior to sunrise on a given day and ending sixty (60) minutes after sunset on such day) and (ii) any daylight period occurring in the months of October or November.</p> <p>For resources other than Solar PV resources, during the Delivery Term, Seller will deliver to Buyer its proposed schedule for Planned Maintenance on or before, in respect of the March/April maintenance period, September 1 of the preceding year, and in respect of the October/November maintenance period, February 1 of the calendar year in which such maintenance period will begin. The Parties will then finalize a mutually acceptable schedule for Planned Maintenance. The expected timing and permitted duration of Planned Maintenance will be consistent with the technology utilized in the Facility.</p> <p>For resources other than Solar PV resources, Seller will deliver to Buyer its proposed schedule for Planned Maintenance sufficiently in advance to allow Buyer a reasonable opportunity to review such schedule.</p>
<p><b>22</b></p>	<p><b>Force Majeure:</b></p>	<p>“<b>Force Majeure</b>” means any event that meets all of the following criteria: (i) the event occurs after the effective date of the Definitive Agreement; (ii) the event and its effects are not within the reasonable control, directly or indirectly, of the Party claiming Force Majeure (including its direct and</p>

The statements contained in this Term Sheet are made subject to the Reservation of Rights set forth in Appendix E of the RFP and the terms and acknowledgements set forth in the Proposal Submission Agreement.

**Term Sheet for PPA Product**

	<p>indirect contractors, subcontractors and suppliers); (iii) the event and its effects are unavoidable or could not be prevented, overcome, or removed by the reasonable efforts and diligence of the Party claiming Force Majeure (including its direct and indirect contractors, subcontractors and suppliers); (iv) the event and its effects do not result from the negligence or fault of the Party claiming Force Majeure (including any breach by such Party of the Definitive Agreement) or the negligence or fault of its direct and indirect contractors, subcontractors and suppliers; and (v) the event causes the Party claiming Force Majeure, despite such Party's (including its direct and indirect contractors', subcontractors' and suppliers') use of reasonable efforts and diligence, to be actually delayed in performing, or unable to perform, its obligations under the Definitive Agreement, in whole or in part (for reasons other than economic hardship, including lack of money).</p> <p>Provided the event meets all of the criteria described above, Force Majeure will include: natural disasters; landslides; droughts; fires; floods; earthquakes; hurricanes; tornados; tsunamis; hail and ice and ice storms that are abnormally severe for the period of time when, and the area where, such weather event or condition occurs; epidemics; wars (whether declared or undeclared) or other armed conflicts; riots; explosions; civil disturbances; sabotage; vandalism; terrorism; documented threats of terrorism; and blockades.</p> <p>Force Majeure will not include: (a) mechanical failure or other breakdown, flaw, defect, or failure of equipment or systems that is not the direct or proximate result of, subject to clauses (d) and (f) of this sentence, acts of God (which acts of God will include floods, earthquakes, hurricanes, and tornadoes), epidemics, wars, riots, civil disturbances, or, subject to clause (b) of this sentence, sabotage; (b) sabotage by employees, agents, representatives, or direct and indirect contractors, subcontractors, and suppliers (including their employees, agents, and representatives) of the Party claiming Force Majeure; (c) delay in obtaining, or failure to obtain or revocation of, a governmental approval; (d) any event stated in the technical specifications of the Facility to be within the tolerance of the Facility; (e) the failure or other act or omission of employees, agents, representatives, or direct and indirect contractors, subcontractors, and suppliers (including their employees, agents and representatives) of the Party claiming Force Majeure (including the failure of a direct or indirect contractor, subcontractor, or supplier to furnish machinery, spare parts, materials, consumables, labor, equipment, or services in accordance with its contractual obligations) or any other non-delivery, delayed delivery, shortages, or other unavailability of machinery, spare parts, materials, consumables, labor, equipment or services (including any interruption or curtailment of electric transmission), unless (1) the Party claiming Force Majeure has a firm contract for the applicable service or item (provided that this clause (1) will apply with respect to electric transmission only to the extent the concept of a firm contract for electric transmission exists</p>
--	---

The statements contained in this Term Sheet are made subject to the Reservation of Rights set forth in Appendix E of the RFP and the terms and acknowledgements set forth in the Proposal Submission Agreement.

**Term Sheet for PPA Product**

		<p>in the relevant context) and (2) (A) in any case other than interruption or curtailment of electric transmission, the provider, if it were a party hereto, would be entitled to Force Majeure protection as an affected party or (B) in any case of interruption or curtailment of electric transmission, the interruption or curtailment is due to “force majeure” or “uncontrollable force” or similar term as defined under the applicable transmission provider’s tariff; (f) any weather event or condition that is not abnormally severe for the period of time when, and the area where, such weather event or condition occurs; (g) Seller’s ability to sell the energy, environmental attributes, capacity, capacity-related benefits, and/or other electric products at a price greater than provided for in the Definitive Agreement; (h) a Party’s financial inability to perform; (i) events that affect the cost of equipment or materials or other costs of the Seller Cost Scope or changes in market conditions affecting the economics of either Party (including a change in commodity prices or increased inflation) or any other economic hardship (including lack of money); (j) wind conditions that do not qualify as a hurricane, tornado, tsunami, or other storm of an equivalent magnitude; (k) {<i>For Solar PV resources</i>} a lack of, or insufficient, solar insolation for energy production, including as a result of environmental or weather conditions, or (l) labor strikes, slowdowns, or stoppages; <u>provided, however</u>, that the existence of one or more of the factors listed in the exceptions to clauses (a), (e), and (f) will not be sufficient to conclusively or presumptively prove the existence of a Force Majeure if the event does not meet the criteria described in the first paragraph of this definition.</p> <p>If Buyer is the Party claiming Force Majeure and does not overcome the Force Majeure for a reasonably sustained period of time and resume performance of its obligations under the Definitive Agreement within (i) twelve (12) months after the inception of such Force Majeure if the Force Majeure commences within the first third of the Delivery Term (rounded to the nearest contract year), (ii) nine (9) months after the inception of such Force Majeure if the Force Majeure commences within the second third of the Delivery Term (rounded to the nearest contract year), or (iii) six (6) months after the inception of such Force Majeure if the Force Majeure commences within the final third of the Delivery Term, then Buyer may, at any time following the end of such twelve (12), nine (9), or six (6)-month period, as applicable, and for so long as performance continues to be delayed or prevented by Force Majeure, terminate the Definitive Agreement upon notice to Seller without liability to either Party arising out of such termination.</p>
23	<b>Replacement Products:</b>	<p>If Seller is not capable of providing the full availability of energy, environmental attributes, capacity, capacity-related benefits, and/or other electric products from the Facility (or portion thereof allocated to Buyer), Seller will have no right and will not be permitted to provide replacement capacity, capacity-related benefits, energy, environmental attributes, and/or other electric products without the prior written consent of Buyer in its sole</p>

The statements contained in this Term Sheet are made subject to the Reservation of Rights set forth in Appendix E of the RFP and the terms and acknowledgements set forth in the Proposal Submission Agreement.

**Term Sheet for PPA Product**

		<p>and absolute discretion. Notwithstanding the foregoing, Seller may make a proposal or offer to Buyer to provide such replacement products. In such event, Buyer may accept or reject, in its sole and absolute discretion, any such proposal or offer from Seller. If Buyer receives such a proposal or offer and Buyer, in its sole and absolute discretion, accepts such proposal or offer in writing, such replacement products will constitute, for the period for which Buyer has agreed that Seller may provide such replacement products and subject to the other terms of such agreement, replacement products for all purposes under the Definitive Agreement, and, except to the extent the Parties have agreed otherwise in writing, Seller will be obligated to provide such replacement products in accordance with the terms of the Definitive Agreement at no additional cost to Buyer.</p> <p>Notwithstanding the foregoing, if the applicable Balancing Authority considers a quantity of energy or other electric products to have been delivered from the Facility (or portion thereof allocated to Buyer) at the Physical Delivery Point for settlement purposes (and credits the Market Participant therefor) even though such energy or other electric products were actually imbalance or real-time energy or other electric products that were directly or indirectly provided by such Balancing Authority, rather than being actually generated by the Facility (or portion thereof allocated to Buyer), then, to the extent Seller pays the Imbalances Charges, BA Penalties, and all other costs associated with such replacement energy or other electric products, such replacement energy and other electric products will automatically be treated as energy and other electric products provided by the Facility (or portion thereof allocated to Buyer) for all purposes, except for purposes of determining satisfaction of Seller’s Annual Guaranteed Energy Quantity commitment and Seller’s related obligation to provide Buyer the environmental attributes that Seller would have been obligated to transfer to Buyer if it had met its Annual Guaranteed Energy Quantity commitment.</p>
24	<b>No QF Put:</b>	<p>Notwithstanding any other provision of the Definitive Agreement, Seller will waive any and all rights to deliver “qualifying facility” energy from the Facility (or portion thereof allocated to Buyer) to the host utility at any time during the Delivery Term and expressly agrees not to deliver “qualifying facility” energy from the Facility (or portion thereof allocated to Buyer) to the host utility at any time during the Delivery Term.</p>
25	<b>Change in Law:</b>	<p>The Parties acknowledge the possibility that a change in law may occur that requires or will require one or both of the Parties to incur additional costs (including environmental costs) during the Delivery Term beyond those projected to be incurred by such Party as of the date of execution of the</p>

The statements contained in this Term Sheet are made subject to the Reservation of Rights set forth in Appendix E of the RFP and the terms and acknowledgements set forth in the Proposal Submission Agreement.

**Term Sheet for PPA Product**

		<p>Definitive Agreement. Notwithstanding the foregoing, if such a change in law occurs, the other Party will not be required to share in, reimburse, or otherwise pay all or any portion of such additional costs, except as expressly provided in the Definitive Agreement, including with respect to items 26 and 38 below.</p>
26	<b>Disallowance:</b>	<p>Please see Section 2.5 of the Main Body.</p>
27	<b>Conditions Precedent:</b>	<p>Without limiting item 30, Buyer’s obligations under the Definitive Agreement will be conditioned upon the fulfillment or express waiver, by Buyer, of numerous conditions, including, without limitation, the following:</p> <ol style="list-style-type: none"> <li>1. Buyer has obtained all approvals, permits, licenses, consents, waivers, and other authorizations from, notifications to, and filings and registrations with, governmental authorities deemed necessary or advisable by Buyer (i) that (a) approve the Definitive Agreement and the transactions thereunder or contemplated thereby, including approval of the full recovery of all Buyer costs associated with the Definitive Agreement and all related agreements and transactions (through base rates, fuel adjustment charges, and/or such other rates or charges as may be applied pursuant to a rider or otherwise) pursuant to a finding that the participation by Buyer in the foregoing is prudent and in the public interest, or (b) provide any other regulatory treatment desired by Buyer of the Definitive Agreement and transactions thereunder or contemplated thereby, and/or (ii) in order for Buyer to enter into the Definitive Agreement and/or perform its obligations thereunder, each of which is on terms and conditions acceptable to Buyer in its sole and absolute discretion and is final and not subject to appeal or otherwise subject to challenge;</li> <li>2. Buyer has obtained all third-party consents, approvals, and authorizations (to the extent not covered by clause 1 above) deemed necessary or advisable by Buyer to enter into the Definitive Agreement and/or perform its obligations thereunder, each of which is on terms and conditions acceptable to Buyer in its sole and absolute discretion;</li> <li>3. <i>{If the Facility is or will be interconnected at a transmission voltage level}</i> the Facility (or the portion thereof allocated to Buyer) has qualified as and is or will be registered and recognized as, as of the start of the Delivery Term commencement date, a Long-Term Network Resource of Buyer, with deliverability on a firm network resource basis in the largest Balancing Authority applicable to the Physical Delivery Point, pursuant to, to the extent such Balancing Authority is MISO, ERIS and NRIS as required herein under the MISO Tariff (or the equivalent service in the event MISO discontinues or modifies the nature of NRIS) or network integration transmission service as required under the MISO</li> </ol>

The statements contained in this Term Sheet are made subject to the Reservation of Rights set forth in Appendix E of the RFP and the terms and acknowledgements set forth in the Proposal Submission Agreement.

**Term Sheet for PPA Product**

		<p>Tariff (or the equivalent service in the event MISO discontinues or modifies the nature of such service);</p> <ol style="list-style-type: none"> <li>4. <i>{If the Facility is or will be interconnected at a distribution voltage level}</i> the Facility (or the portion thereof allocated to Buyer) has qualified as and is or will be registered and recognized as, as of the start of the Delivery Term commencement date, a Load Modifying Resource or other form of distribution-level resource recognized by MISO or such other applicable Balancing Authority.</li> <li>5. if required, credit support meeting the requirements of the Definitive Agreement has been posted by Seller and remains in full force and effect;</li> <li>6. certificates of insurance evidencing the coverages required by the Definitive Agreement have been obtained and submitted to Buyer and the insurance required by the Definitive Agreement remains in full force and effect;</li> <li>7. <i>{If the Facility is or will be interconnected at a transmission voltage level }</i> the Balancing Authority(ies) applicable to the Physical Delivery Point recognize the Facility (or portion thereof allocated to Buyer) as a separate generating resource and the Physical Delivery Point as a separate CP Node for settlement purposes (including that such Balancing Authority(ies) determine separately for settlement purposes the amount of energy actually delivered specifically from the Facility (or portion thereof allocated to Buyer) to the Physical Delivery Point and, if applicable, recognize the Facility (or portion thereof allocated to Buyer) as a separate generating resource for scheduling, offering, and bidding purposes);</li> <li>8. Seller or, if applicable, Buyer (or an Affiliate designated to Seller by Buyer) has been designated as the exclusive representative of the Facility before each Balancing Authority applicable to the Physical Delivery Point (including any applicable RTO or ISO) for purposes of the functions described in item 15 above (with effect, if Buyer or its Affiliate is such representative, as of the start of the Delivery Term or the deadline for Buyer to register as such representative under the applicable rules of the Balancing Authority);</li> <li>9. Seller will deliver to Buyer a certification from Seller’s Principal Accounting Officer (as defined by the rules of the Securities and Exchange Commission) that, to the best of the Principal Accounting Officer’s knowledge, the Definitive Agreement and the transactions thereunder or contemplated thereby do not and will not result in, under the accounting standards existing at the time of the certification or that will be in effect during the term of the Definitive Agreement, the recognition of a long-term liability by Buyer or any of its Affiliates on</li> </ol>
--	--	---

The statements contained in this Term Sheet are made subject to the Reservation of Rights set forth in Appendix E of the RFP and the terms and acknowledgements set forth in the Proposal Submission Agreement.



**Term Sheet for PPA Product**

		<p>its or any of its Affiliates’ books and addressing any other accounting-related risks relating to the Definitive Agreement deemed necessary or advisable by Buyer in its sole and absolute discretion;</p> <p>10. {<i>For Developmental Resources</i>} the COD has occurred; and</p> <p>11. if applicable, Seller has satisfied the condition precedent referenced in item 33 below.</p> <p>Buyer conditions precedent in addition to those specified above may be required as a result of operational aspects of the specific proposed generating resource, the Facility not being directly interconnected to the MISO System, special considerations or other provisions included in the proposal selected for contract negotiation that are addressed in the Definitive Agreement, diligence conducted by or for Buyer, the status of applicable laws, rules, and regulations, and other factors as Buyer deems relevant in its sole and absolute discretion. Buyer will have a defined period of time from the effective date of the Definitive Agreement to satisfy its conditions to commencement of the Delivery Term.</p>
28	<b>Completion:</b>	<p>{<i>For Developmental Resources only</i>} The date by which the COD must occur is expected to be the date specified as such by Bidder in the proposal (as such date may be extended on a day-for-day basis, up to a maximum of 180 days in the aggregate, to the extent that the COD is delayed as a result of Force Majeure, the “<b>Guaranteed COD</b>”). The “<b>Commercial Operation Date,</b>” or “<b>COD,</b>” will be the date all of the following conditions have been satisfied or expressly waived by Buyer:</p> <p>(a) the Facility has achieved “Substantial Completion” (or equivalent term meaning completion in all material respects, except punch list items that do not materially adversely affect the ability of the Facility to operate as intended) under its engineering, procurement, and construction contract (or, if the Facility does not have a single engineering, procurement, and construction contract, under each of the subcontracts that together aggregate the scope of an engineering, procurement, and construction contract) at a nameplate capacity equal to that specified in item 4 above and studies and testing of the Facility required pursuant to its interconnection agreement(s), financing documents, or permits, authorizations, or other project documents for the commencement of commercial operation will have been successfully performed and completed;</p> <p>(b) the Facility (i) has successfully completed a capacity demonstration test at a capacity equal to at least 95% of the full nameplate capacity specified by Bidder in the applicable proposal, (ii) has achieved initial synchronization with the grid, (iii) is available for normal and continuous operation and fully capable of reliably producing the energy,</p>

The statements contained in this Term Sheet are made subject to the Reservation of Rights set forth in Appendix E of the RFP and the terms and acknowledgements set forth in the Proposal Submission Agreement.

**Term Sheet for PPA Product**

		<p>environmental attributes, capacity, capacity-related benefits, and other electric products and delivering the same at the Physical Delivery Point at the full nameplate capacity specified by Bidder in the applicable proposal, and (iv) is in compliance with the applicable interconnection agreements and applicable laws;</p> <p>(c) <i>{If the Facility is or will be directly interconnected to the MISO System at a transmission voltage level}</i> the required quantities of ERIS and NRIS have been received and the interconnection, deliverability, and transmission agreements have been executed and are effective and the interconnection, deliverability, and transmission upgrades required by such agreements for the Facility (i) have been completed, (ii) have been tested in accordance with such agreements and any applicable laws, (iii) are available for normal and continuous operation and fully capable of reliably transmitting and delivering the capacity, energy, and other electric products to Buyer at the Physical Delivery Point at the full Capacity Allocated to Buyer, and (iv) are in compliance with such agreements and applicable laws;</p> <p><i>{If the Facility is or will be interconnected at a transmission voltage level but is not or will not be directly interconnected to the MISO System}</i> the required interconnection, deliverability, and transmission agreements have been executed and are effective and the deliverability and transmission upgrades required by Buyer’s request for full network integration transmission service or similar service for the energy delivered from the Facility (or portion thereof allocable to Buyer) (i) have been completed, (ii) have been tested in accordance with any applicable agreements and laws, (iii) are available for normal and continuous operation and fully capable of reliably transmitting and delivering the capacity, energy, and other electric products to Buyer at the Physical Delivery Point at the full Capacity Allocated to Buyer, and (iv) are in compliance with any such agreements and applicable laws;</p> <p><i>{If the Facility is or will be interconnected at a distribution voltage level}</i> the required quantity of interconnection service has been obtained and the interconnection and distribution agreements have been executed and are effective and the Facility has been interconnected, in accordance with the distribution interconnection procedures and requirements established from time to time by ENOI, to a portion of the distribution system owned by ENOI and (i) has been tested in accordance with any applicable agreements and laws, (ii) is available for normal and continuous operation and fully capable of reliably transmitting and delivering the capacity, energy, and other electric products to Buyer at the Physical Delivery Point at the full Capacity Allocated to Buyer, and (iii) is in compliance with the applicable interconnection and distribution agreements and applicable</p>
--	--	---

The statements contained in this Term Sheet are made subject to the Reservation of Rights set forth in Appendix E of the RFP and the terms and acknowledgements set forth in the Proposal Submission Agreement.

**Term Sheet for PPA Product**

		<p>laws and health and safety standards (such as, for purposes of illustration only, IEEE 1547);</p> <p>(d) the communications and telemetry equipment required by the Definitive Agreement has been programmed, installed, commissioned, and tested and has demonstrated that it is fully capable of reliably transmitting real-time data to Buyer according to the Definitive Agreement;</p> <p>(e) Seller is in compliance in all material respects with the Definitive Agreement and there are no defaults (or events or circumstances that with the passage of time or the giving of notice or both would constitute a default) of Seller thereunder that have occurred and are continuing;</p> <p>(f) Seller has obtained all material permits and other authorizations, entered into all agreements, and made all other arrangements and acquired all other tangible and intangible rights required to construct the Facility and produce and deliver the energy, environmental attributes, capacity, capacity-related benefits, and other electric products at the Physical Delivery Point pursuant to the Definitive Agreement and otherwise perform its obligations according to the Definitive Agreement; such permits and authorizations, agreements, arrangements, and other rights are in full force and effect and not subject to conditions precedent; and no party thereto is in default thereunder, and no event or circumstance will have occurred and be continuing that with the passage of time or the giving of notice or both would constitute a default by a party thereunder;</p> <p>(g) the Facility, capacity, energy, or environmental attributes, as applicable, are certified for any program or system that becomes an applicable environmental attribute program as of the COD;</p> <p>(h) (i) Seller is otherwise qualified for, and has all necessary accounts to obtain and transfer to Buyer, the environmental attributes corresponding to such applicable environmental attribute programs, (ii) all documents have been executed and filed and all other actions have been taken that are necessary or advisable to obtain all capacity-related benefits for which the capacity or the Facility is eligible and to transfer to Buyer custody of, and give effect to and evidence the title of Buyer in, all such capacity-related benefits, in accordance with the Definitive Agreement and (iii) all documents have been executed and filed and all other actions have been taken that are necessary or advisable to qualify to provide, and sell and deliver at the Physical Delivery Point, all other electric products (including for Buyer or Seller, as applicable, to be able to schedule, offer, bid, and settle the other electric products into the Balancing Authority(ies) applicable to the Physical Delivery Point), in accordance with the Definitive Agreement;</p>
--	--	---

The statements contained in this Term Sheet are made subject to the Reservation of Rights set forth in Appendix E of the RFP and the terms and acknowledgements set forth in the Proposal Submission Agreement.

**Term Sheet for PPA Product**

	<p>(i) without limiting clause (f) above, all arrangements for the supply of required electric services to the Facility, including the supply of house power and maintenance power, have been completed by Seller separately from the Definitive Agreement, are in effect, and are available for the supply of such electric services to the Facility;</p> <p>(j) certificates of insurance evidencing the coverages required by the Definitive Agreement at the COD have been obtained and submitted to Buyer;</p> <p>(k) Seller has provided to Buyer copies of the major design drawings and electrical specifications relating to the Facility;</p> <p>(l) any additional credit support required at the COD pursuant to the Definitive Agreement has been posted by Seller in accordance with the requirements of the Definitive Agreement; and</p> <p>(m) staffing and training of Seller’s personnel for the operation, maintenance, and asset management of the Facility has been completed, to Seller’s reasonable satisfaction.</p> <p>Conditions in addition to those specified above may be required to achieve COD as a result of operational aspects of the specific proposed generating resource, the Facility not being directly interconnected to the MISO System, special considerations or other provisions included in the proposal selected for contract negotiation that are addressed in the Definitive Agreement, diligence conducted by or for Buyer, the status of applicable laws, rules, and regulations, and other factors as Buyer deems relevant in its sole and absolute discretion.</p> <p>Seller will notify Buyer immediately when the COD has occurred, including in such notice reasonable evidence to Buyer of the satisfaction of all of the conditions set forth above and a certification to that effect by an officer of Seller having responsibility for construction of the Facility after due inquiry of Seller. The Definitive Agreement will require Seller to provide periodic progress reports to Buyer and will grant to Buyer inspection and other rights applicable during the pre-commercial operation phase of the Definitive Agreement.</p> <p>If the COD does not occur on or before the Guaranteed COD specified by Bidder, Seller will pay to Buyer liquidated damages, for each day after the Guaranteed COD until the COD. The liquidated damages payable by Seller for such delays will be designed to address potential costs, charges, and losses of Buyer in the markets of MISO or any other applicable Balancing Authority (including capacity and energy markets) arising out of Seller’s failure to meet the Guaranteed COD and, accordingly, may not have a uniform value for each day of delay. Seller’s aggregate liability for liquidated damages pursuant to this paragraph will be limited to a finite number negotiated by the Parties.</p>
--	--

The statements contained in this Term Sheet are made subject to the Reservation of Rights set forth in Appendix E of the RFP and the terms and acknowledgements set forth in the Proposal Submission Agreement.

**Term Sheet for PPA Product**

		<p>If the COD does not occur on or before the date after the Guaranteed COD on which the delay liquidated damages cap is reached (180 days if the liquidated damages are constant day-for-day):</p> <p>(i) Buyer will have the right, at any time thereafter until the COD occurs, to (a) terminate the Definitive Agreement upon notice to Seller (and to receive termination damages arising out of any such termination) or (b) if Seller has satisfied all of the conditions to the COD other than conditions (b)(i) and (b)(iii), require Seller to re-size (and, if so required to re-size, Seller will re-size) the original Capacity Allocated to Buyer to the then-tested Capacity Allocated to Buyer; and</p> <p>(ii) if (a) Buyer’s right to terminate set forth in clause (i) above applies and Buyer has not elected to terminate within 30 days after obtaining such right pursuant to clause (i) above, (b) Seller has satisfied all of the conditions to the COD other than conditions (b)(i) and (b)(iii), and (c) Seller demonstrates to Buyer’s reasonable satisfaction that it is not possible to achieve a tested capacity equal to at least 95% of the full nameplate capacity specified by Bidder in the applicable proposal, Seller will have the right, at any time thereafter until the COD occurs, to re-size the original Capacity Allocated to Buyer to the then-tested Capacity Allocated to Buyer.</p> <p>If Buyer requires Seller to, or Seller elects to, re-size the original Capacity Allocated to Buyer according to clause (i) or (ii) above, Seller will pay to Buyer an amount equal to (a) a \$/MW figure to be negotiated by the Parties multiplied by (b) the difference between (1) the full expected Capacity Allocated to Buyer as specified by Bidder in item 10 above and (2) the re-sized Capacity Allocated to Buyer. Upon such payment, conditions (b)(i) and (b)(v) to the COD will be deemed achieved.</p>
29	<b>Management Approval:</b>	<p>The Definitive Agreement is subject to review and concurrence or approval, as applicable, by the corporate risk office of Entergy Corporation, the board of directors of Buyer, the executive and senior management of Entergy Corporation and Buyer, and such other approvals of Entergy Corporation and its affiliates as Buyer deems necessary or prudent in its sole and absolute discretion to enter into the Definitive Agreement and perform its obligations thereunder (on the terms set forth therein). Buyer will not execute or deliver the Definitive Agreement without such review and concurrence or approval, as applicable, and such approval or concurrence may be granted or denied in such bodies’ sole and absolute discretion.</p>
30	<b>Select Contract Terms and Conditions:</b>	<p>The Definitive Agreement will also include, among other things, the following covenants, terms, and/or conditions:</p> <ul style="list-style-type: none"> <li>• Seller will insure, develop, engineer, procure equipment for, design, construct, install, operate, maintain, manage, replace, repair, study, test,</li> </ul>

The statements contained in this Term Sheet are made subject to the Reservation of Rights set forth in Appendix E of the RFP and the terms and acknowledgements set forth in the Proposal Submission Agreement.

**Term Sheet for PPA Product**

		<p>and otherwise use the Facility in accordance with (i) Seller’s obligations in the Definitive Agreement, the Facility’s interconnection agreements, and the other project documents, (ii) accepted electrical practices, and (iii) all applicable laws (including environmental laws), consents, and governmental approvals, including all applicable standards and guidelines adopted from time to time by governmental authorities (including NERC, SERC Reliability Corporation, any RTO and any comparable third party with the right to impose on the Facility or Seller conditions or obligations having the effect of an applicable law or other binding legal requirement);</p> <ul style="list-style-type: none"> <li>• Seller will maintain adequate reserves for, and schedule and perform according to the Definitive Agreement, required maintenance; and</li> <li>• Seller will insure against all insurable risks with coverage in an amount not less than full replacement cost and on terms specified in the Definitive Agreement.</li> </ul>
31	<b>Events of Default:</b>	<p>The Definitive Agreement will include the following events of default of Seller:</p> <ul style="list-style-type: none"> <li>• failure to pay amounts due or submit or confirm Financial Schedules as required by the Definitive Agreement;</li> <li>• breach of representations and warranties;</li> <li>• failure to provide or maintain required credit support;</li> <li>• breach of covenants;</li> <li>• assignment by Seller of the Definitive Agreement or sale or transfer of the Facility, directly or indirectly, except as permitted by the Definitive Agreement;</li> <li>• bankruptcy, dissolution, or liquidation of Seller;</li> <li>• Seller makes any material intentional misrepresentation or omission in any metering report, invoice, or generation forecast required to be made or furnished by Seller pursuant to the Definitive Agreement or Seller’s actual fraud, tampering with Buyer-owned facilities, or material intentional misrepresentation or misconduct in connection with the Definitive Agreement or operation or performance of the Facility;</li> <li>• Except as expressly provided by the Definitive Agreement, Seller sells, assigns, or otherwise transfers, or commits to sell, assign, or otherwise transfer, the energy, environmental attributes, capacity, capacity-related benefits, or other electric products that are subject to the Definitive Agreement, or any portion thereof, to any person other than Buyer;</li> </ul>

The statements contained in this Term Sheet are made subject to the Reservation of Rights set forth in Appendix E of the RFP and the terms and acknowledgements set forth in the Proposal Submission Agreement.

**Term Sheet for PPA Product**

		<ul style="list-style-type: none"> <li>• Seller fails to deliver to Buyer energy under the Definitive Agreement in an amount at or above (a) the Minimum Two Consecutive Contract Year Energy Quantity during each of any two (2) consecutive contract years or (b) the Minimum Three Contract Year Energy Quantity during each of any three (3) contract years;</li> <li>• default of Seller under, or failure to maintain in effect, any project document (including the electric interconnection agreements and any transmission or deliverability service-related agreement);</li> <li>• Seller’s abandonment of construction or operation of the Facility (or any portion thereof affecting its obligations under the Definitive Agreement);</li> <li>• the commencement of the Delivery Term is delayed for a period of 180 days or more from the date that the Delivery Term would have commenced as a result of the occurrence of a unit contingency or other limitation, including a Force Majeure, that, individually or collectively, reduces the amount of available capacity to ten percent (10%) or more below the Capacity Allocated to Buyer;</li> <li>• Seller fails to maintain in effect any agreement or arrangement required to deliver energy, environmental attributes, capacity, capacity-related benefits, and other electric products to the Physical Delivery Point;</li> <li>• failure of the resulting, surviving, or transferee entity in a merger or sale of all or substantially all of the assets of Seller to assume such party’s obligations under the Definitive Agreement;</li> <li>• {<i>For Developmental Resources</i>} the Commercial Operation Date has not occurred within 180 days after the Guaranteed Commercial Operation Date; and</li> <li>• the failure to maintain any necessary qualification for, or any necessary account to obtain and transfer to Buyer, any capacity-related benefits, environmental attributes, or other electric products for which the Facility or its capacity or energy is eligible.</li> </ul> <p>The foregoing events of default are illustrative. Other events of default will be included in the Definitive Agreement as appropriate.</p>
32	<b>Termination Rights:</b>	<p>The Definitive Agreement will contain provisions entitling a Party the right to terminate the Definitive Agreement upon the occurrence and continuation of an event of default by the other Party and to calculate termination damages based on the costs, gains, or losses incurred by the non-defaulting Party arising out of termination of the Definitive Agreement. If the termination damages are negative, the non-defaulting Party will not be obligated to pay such amount to the defaulting Party.</p>

The statements contained in this Term Sheet are made subject to the Reservation of Rights set forth in Appendix E of the RFP and the terms and acknowledgements set forth in the Proposal Submission Agreement.

**Term Sheet for PPA Product**

		<p>{<i>For Developmental Resources</i>} The Definitive Agreement will include rights in favor of Buyer to terminate the Definitive Agreement for convenience, in its sole and absolute discretion, after the satisfaction or waiver of the first two conditions set forth in item 27 above (regarding Buyer’s required approvals and consents), financing for the Facility has been obtained by Seller, and Seller has issued a notice to proceed with construction of the Facility but prior to the achievement of Commercial Operation. If Buyer terminates the Definitive Agreement pursuant to such rights, Buyer will be required, as Seller’s sole remedy arising out of such termination, to pay to Seller a pre-agreed amount to be set forth in a schedule to the Definitive Agreement to be negotiated between Buyer and Seller. The amounts set forth in such schedule will vary according to when such termination occurs and will not exceed the actual, direct out-of-pocket costs reasonably incurred by Seller to terminate construction (or, if lesser, to complete construction and make alternate use) of the Facility (or portion thereof allocated to Buyer) at such time. Seller will be required to use commercially reasonable efforts to minimize any such actual, direct out-of-pocket costs.</p>
33	<b>Audit Rights:</b>	<p>Buyer will have the right to examine the books and records of Seller and any affiliates of Seller involved, directly or indirectly, in the transactions or actions contemplated by the Definitive Agreement, including the records for the Facility. Such records will include (i) actual generating records for the Facility, (ii) the records required to be kept according to the Definitive Agreement and in the immediately following sentence and (iii) copies of contracts relating to the Facility to the extent reasonably necessary or appropriate to verify, among other things, (a) the accuracy of any statement, charge, or computation made pursuant to the provisions of the Definitive Agreement or (b) Seller’s performance under or compliance with the terms of the Definitive Agreement. Seller will be responsible for ensuring that all subcontractors commit to supply to Seller, and allow Seller to freely provide to Buyer, the records supporting any cost or charge paid by Seller and passed on to Buyer according to the terms of the Definitive Agreement. All books, records, and data, including all copies thereof, provided to Buyer under this paragraph will be subject to the confidentiality requirements of the Definitive Agreement. As a condition precedent to the Definitive Agreement becoming effective, to the extent that Seller is not the owner of the Facility, Seller will provide to Buyer evidence satisfactory to Buyer of its ability and rights to facilitate Buyer’s access to the books and records of such owner pursuant to the provisions of the audit section of the Definitive Agreement.</p>
34	<b>Seller’s Use of Information:</b>	<p>Seller will limit the availability and disclosure of information with respect to scheduling, offering, bidding, settlements, dispatch, outages, unit contingencies, and other limitations relating to the Facility (or portion thereof allocated to Buyer) or the Definitive Agreement exclusively to the scheduling, operations, and asset management personnel designated by Seller to Buyer in</p>

The statements contained in this Term Sheet are made subject to the Reservation of Rights set forth in Appendix E of the RFP and the terms and acknowledgements set forth in the Proposal Submission Agreement.



**Term Sheet for PPA Product**

		<p>writing from time to time who are primarily responsible for the day-to-day operation and/or management of the Facility. Seller and such personnel may use all such information only for the limited purpose of operating, scheduling and offering the Facility as contemplated hereunder and performing their respective directly-related duties under the Definitive Agreement. Without limiting the generality of the foregoing, Seller and its designees will be expressly forbidden from using, directly or indirectly, any such information, or knowledge thereof, (i) in connection with any activity in which Buyer and Seller (or, if it does not employ its designees, the employer(s) of such designees) compete or where the knowledge or possession of such information would provide, or reasonably be expected to provide, Seller (or such employer(s)) with a competitive advantage or (ii) in contravention, violation, or breach of any applicable law, code of conduct, or binding agreement, including any confidentiality agreement. Seller will be responsible for any unauthorized disclosure or use by personnel designated by Seller or performing work for or on behalf of Seller or any of its Affiliates of any of the information protected under the Definitive Agreement.</p>
<p><b>35</b></p>	<p><b>Right of First Refusal:</b></p>	<p>Seller will not (and will not permit any direct or indirect parent or affiliate of Seller to) sell or transfer the Facility or any portion thereof or any undivided interest therein (or any direct or indirect equity interests in Seller), including by merger, consolidation, or sale of all or substantially all of its assets, unless prior to such sale or transfer, Seller provides written notice of such sale or transfer to Buyer that includes a copy of the definitive agreement for such sale or transfer. Upon Buyer’s receipt of such notice, Buyer will have the right, for 120 days, to enter into (or cause a nominee to enter into) a purchase agreement on substantially the same terms and conditions set forth in the definitive agreement included in Seller’s notice, provided that (i) if such definitive agreement specifies any non-cash consideration, Buyer (or its nominee) may pay the cash equivalent of such non-cash consideration, or (ii) if any governmental or regulatory approvals or other consents or authorizations are required for Buyer to consummate the transaction, Buyer will have a reasonable period of time to seek and obtain all necessary approvals, consents or authorizations (with times and on terms consistent with those applicable to Buyer’s approvals, consents, and authorizations under the Definitive Agreement). Seller will provide, in a timely manner, information regarding the Facility that is reasonable or customary to allow Buyer to perform due diligence and to otherwise evaluate in good faith the purchase of the Facility. Seller will covenant to cooperate with Buyer in good faith in the event Buyer exercises such right.</p> <p>In the event that Buyer does not exercise its right to purchase, then, subject to item 36 below, Seller (or any direct or indirect parent or affiliate of Seller) will have the right to consummate the sale or transfer according to the definitive agreement included in Seller’s notice to Buyer (excluding any amendments</p>

The statements contained in this Term Sheet are made subject to the Reservation of Rights set forth in Appendix E of the RFP and the terms and acknowledgements set forth in the Proposal Submission Agreement.

**Term Sheet for PPA Product**

		<p>thereto that make such definitive agreement more favorable to the purchaser), provided that such sale or transfer is consummated within 180 days after the date that Buyer elects not to exercise its right to purchase (or such right to purchase expires). If Seller does not consummate the sale or transfer in accordance with the preceding sentence within such 180 days, Seller will not (and will not permit any direct or indirect parent or affiliate of Seller to) sell or transfer the Facility (or its direct or indirect equity interests in Seller), unless prior to such sale or transfer, Seller provides a new written notice of such sale or transfer to Buyer and these provisions are applied with respect to such new written notice.</p>
<p><b>36</b></p>	<p><b>Other Transfer Restrictions:</b></p>	<p>Except as expressly permitted in the following paragraph, Seller will not (and will not permit any affiliate to) sell or transfer all or a material portion of, or an undivided interest in, the Facility (or such affiliate’s direct or indirect equity interests in Seller), including by merger, consolidation, or sale of all or substantially all of its assets, without Buyer’s prior written consent, which will not be unreasonably withheld or delayed, provided that it will be deemed reasonable for Buyer to withhold its consent if (a) the proposed transferee is not a qualified operator, (b) the proposed transferee has a creditworthiness below that of Seller or, in the case of a transfer of the direct or indirect equity interest in Seller (or portion thereof), Seller’s affiliate effecting such transaction, (c) the proposed transferee is (i) a load-serving entity (or an affiliate of a load-serving entity) recognized by an applicable governmental authority or (ii) owns or controls (or an affiliate thereof owns or controls) 1,000 MW or more of electric generation capacity, (d) the proposed transferee is, or during the period commencing four (4) years prior to the date of Seller’s notice requesting consent to the transfer until the date of the transfer has been, involved in Adverse Litigation, (e) any credit support provided by Seller prior to such sale or transfer would not remain in effect (or would not continue to be drawable against all obligations of “Seller” hereunder, whether relating to the period before, on or after the date of the transfer) or be substituted with credit support acceptable to Buyer in its sole and absolute discretion, or (f) in the case of a transfer of the Facility (including an undivided interest therein) or portion thereof, Seller does not concurrently assign its rights and obligations under the Definitive Agreement to the transferee of the Facility according to the assignment provisions thereof on terms acceptable to Buyer in its sole and absolute discretion.</p> <p>Seller will have the right to (a) permit any affiliate to transfer (direct or indirect) control of, or all of its direct or indirect equity interests in, Seller, including by merger, consolidation or sale of all or substantially all of its assets, and (b) transfer the Facility, in each case to an affiliate of Seller, provided that (i) at least sixty (60) days prior to such transfer, Seller provides notice to Buyer thereof, (ii) the proposed transferee is a qualified operator, (iii) the proposed transferee has a creditworthiness equal to or better than that of</p>

The statements contained in this Term Sheet are made subject to the Reservation of Rights set forth in Appendix E of the RFP and the terms and acknowledgements set forth in the Proposal Submission Agreement.

**Term Sheet for PPA Product**

		<p>the transferor, (iv) any credit support provided by Seller prior to such sale or transfer remains in effect (and continues to be drawable against all obligations of “Seller” hereunder, whether relating to the period before, on or after the date of the transfer) or is substituted with credit support acceptable to Buyer in its sole and absolute discretion, and (v) in the case of a transfer of the Facility (including an undivided interest therein) or portion thereof, Seller concurrently assigns its rights and obligations under the Definitive Agreement to the proposed transferee according to the assignment provisions thereof on terms acceptable to Buyer in its sole and absolute discretion.</p> <p>“<b>Adverse Litigation</b>” will mean litigation or arbitration that is adverse to Buyer or any affiliate thereof that involves or involved, as the case may be, (i) the potential imposition of criminal liability on Buyer or any affiliate thereof (or their respective directors, officers, partners, members, trustees, employees, agents, or representatives), (ii) the potential imposition on Buyer or any regulated affiliate thereof of new or additional adverse regulation, (iii) claims against Buyer or any affiliate thereof (or their respective directors, officers, partners, members, trustees, employees, agents, or representatives) for slander, libel, defamation, damage to reputation, or other similar legal claims, or (iv) an amount in controversy exceeding (a) \$1,500,000, if the time such litigation or arbitration is being evaluated for purposes of determining qualification under the definition hereof occurs prior to the seventh (7<sup>th</sup>) anniversary of the Delivery Term commencement date set forth in item 8 and (b) an amount escalating by \$1,000,000 on every seventh (7<sup>th</sup>) anniversary of the Delivery Term commencement date set forth in item 8.</p>
37	<b>Credit Support:</b>	<p>Seller will be expected to meet the credit support requirements detailed in the RFP, including Appendix F, and other credit-related terms, all of which will be more fully developed in the Definitive Agreement.</p>
38	<b>Accounting:</b>	<p>Seller will be required to make representations, warranties, and covenants that fully protect Buyer against the accounting treatment described in clause (9) of item 27 above. In connection therewith, each contract year Seller will provide a bring-down certification from Seller’s Principal Accounting Officer affirming the statements made in the certification described in clause (9) of item 27 above as of the time such bring-down certification is provided. Without limiting the foregoing, Seller will be required to provide to Buyer any information requested by Buyer in order to assess those risks and, if any such risks materialize, for Buyer or Seller (or, in each case, any of its affiliates) to comply with the associated accounting requirements. Further, if any such risk materializes prior to the inception or during the term of the Definitive Agreement, Seller must promptly notify Buyer and Buyer will have the right, but not the obligation, (i) to require Seller to modify or amend the Definitive Agreement or enter into alternative arrangements as necessary or advisable for Buyer to avoid, minimize or mitigate such risk (in which event the Parties will</p>

The statements contained in this Term Sheet are made subject to the Reservation of Rights set forth in Appendix E of the RFP and the terms and acknowledgements set forth in the Proposal Submission Agreement.

**Term Sheet for PPA Product**

		make such modifications or amendments or enter into such arrangements as expeditiously as practicable) and/or (ii) to terminate the Definitive Agreement upon notice to Seller, with a termination payment due to Buyer if the termination is due to the materialization of a risk that, under terms to be negotiated and specified in the Definitive Agreement, constitute an event of default of Seller.
<b>39</b>	<b>Confidentiality:</b>	Each Party will be required to keep the terms and provisions of the Definitive Agreement confidential and prohibited from disclosing such terms to any third party, subject to certain limited exceptions specified in the Definitive Agreement.

The statements contained in this Term Sheet are made subject to the Reservation of Rights set forth in Appendix E of the RFP and the terms and acknowledgements set forth in the Proposal Submission Agreement.

## **Term Sheet for PPA Product**

### **Attachment A**

#### **Financial Schedule Examples**

The following examples illustrate the operation of the Financial Schedule provisions of this Term Sheet under different scenarios. For purposes of the following examples, unless otherwise expressly stated, (i) the Capacity Allocated to Buyer is 20 MW, (ii) Seller's generation forecast indicates that 15 MWh of energy are expected to be delivered during the applicable hour, (iii) Buyer communicates a Minimum Settlement Price of \$0, (iv) the applicable settlement interval is one (1) hour, and (v) the Financial Schedule will meet the requirements set forth in item 16, including, without limitation, by designating the Physical Delivery Point as Source Point and the Financial Settlement Point as both the Internal Delivery Point and the Sink Point.

#### **Example 1.**

The LMP at the Financial Settlement Point for the settlement interval in the MISO Day-Ahead Energy Market and the MISO Real-Time Energy Market is \$10. 15 MWh of energy are delivered to the Physical Delivery Point for the settlement interval. The Financial Schedule will be a day-ahead Financial Schedule for 15 MWh.

#### **Example 2.**

Same facts as Example 1 above, except that 17 MWh of energy are delivered to the Physical Delivery Point for the settlement interval. The Financial Schedule will be a day-ahead Financial Schedule for 17 MWh.

#### **Example 3.**

Same facts as Example 1 above, except that 12 MWh of energy are delivered to the Physical Delivery Point for the settlement interval. The Financial Schedule will be a day-ahead Financial Schedule for 12 MWh.

#### **Example 4.**

The LMP at the Financial Settlement Point for the settlement interval is -\$10 in the MISO Day-Ahead Energy Market and \$10 in the MISO Real-Time Energy Market. 15 MWh of energy are delivered to the Physical Delivery Point for the settlement interval. The Financial Schedule will be a real-time Financial Schedule for 15 MWh.

The statements contained in this Term Sheet are made subject to the Reservation of Rights set forth in Appendix E of the RFP and the terms and acknowledgements set forth in the Proposal Submission Agreement.

## Term Sheet for PPA Product

### Example 5.

The LMP at the Financial Settlement Point for the settlement interval is \$10 in the MISO Day-Ahead Energy Market and -\$10 in the MISO Real-Time Energy Market. 15 MWh of energy are delivered to the Physical Delivery Point for the settlement interval. The Financial Schedule will be a day-ahead Financial Schedule for 15 MWh.

### Example 6.

The LMP at the Financial Settlement Point for the settlement interval in the MISO Day-Ahead Energy Market and the MISO Real-Time Energy Market is -\$10. In accordance with the third paragraph of item 19, the Facility would have been capable of generating 15 MWh of energy and delivering it to the Physical Delivery Point for the settlement interval. Buyer is deemed to have curtailed the energy capable of being generated and delivered to the Physical Delivery Point. Buyer will pay Seller for 15 MWh of Buyer-Curtailed Energy in accordance with item 19. As a result of Buyer's curtailment, there will not be any Financial Schedule submitted with respect to the settlement interval.

### Example 7.

The LMP at the Financial Settlement Point and the Physical Delivery Point for the settlement interval is \$10 in the MISO Day-Ahead Energy Market and the LMP at the Physical Delivery Point for the settlement interval is -\$10 in the MISO Real-Time Energy Market. In accordance with the third paragraph of item 19, the Facility would have been capable of generating 15 MWh of energy and delivering it to the Physical Delivery Point for the settlement interval. 5 MWh of energy were actually generated by the Facility and delivered to the Physical Delivery Point for the settlement interval and 10 MWh are MISO Curtailed Energy. The settlement for the settlement interval will be pursuant to (i) a day-ahead Financial Schedule for 15 MWh and (ii) a real-time Financial Schedule structured such that Buyer receives the credit or payment from MISO for the 10 MWh of MISO Curtailed Energy.

The statements contained in this Term Sheet are made subject to the Reservation of Rights set forth in Appendix E of the RFP and the terms and acknowledgements set forth in the Proposal Submission Agreement.



***Appendix B-2***

***Term Sheet for Asset Acquisitions***

***For***

***2016 Request For Proposals***

***For***

***Long-Term Renewable Generation***

***Resources***

***For***

***Entergy New Orleans, Inc.***

Entergy Services, Inc.  
July 13, 2016

### Term Sheet for Asset Acquisitions

The following bid submission term sheet (this “**Term Sheet**”) describes certain terms and conditions of a potential agreement between Buyer (as defined in item 2 below) and the seller proposed by the applicable bidder (“**Bidder**”) in Bidder’s proposal submitted in the RFP (“**Seller**” and, together with Buyer (defined below), the “**Parties**”) for the purchase by Buyer of a solar photovoltaic (“Solar PV”) resource meeting the requirements of the RFP and related assets. The terms set forth in this Term Sheet will establish the basis for the negotiation and execution of a definitive agreement between Buyer and each Seller whose proposal is selected by Entergy Services, Inc. (“**ESI**”) for contract negotiations (the “**Definitive Agreement**”), with necessary changes to accurately reflect any special exceptions set forth in Bidder’s proposal that are accepted by Buyer in its sole and absolute discretion. Buyer will provide the initial draft of the Definitive Agreement to the selected third-party Bidder (if any) at the beginning of contract negotiations.

If Bidder is unable or unwilling to accept one or more of the terms and conditions set forth in this Term Sheet or wishes to propose any alternate or additional terms or conditions (such as a buy-out option at some point during the term of the Definitive Agreement), Bidder should indicate in the “Special Considerations” section of its Proposal Package (i) the terms and conditions to which Bidder takes exception, describing with specificity any terms and conditions that Bidder proposes in substitution therefor, and/or (ii) the additional terms and conditions that Bidder proposes as a supplement to the terms and conditions in this Term Sheet. Bidder is advised to refer to Section 2.2 in the Main Body for additional information pertaining to Special Considerations.

	Proposal Term	Description of Proposal Term
1	<b>Product Description:</b>	The product described in this Term Sheet is designated as the “ <b>Asset Acquisition Product</b> .” This product provides for generation capacity of (i) not more than 20 MW and not less than 1 MW of nameplate capacity from a designated solar photovoltaic (“ <b>Solar PV</b> ”) resource (other than an Aggregated Solar PV Resource (as defined and discussed below)) capable of meeting the requirements of this product or (ii) not more than 5 MW (AC) and not less than 1 MW (AC) of nameplate capacity from an Aggregated Solar PV Resource capable of meeting the requirements of this product (in either case, the “ <b>Facility</b> ”). “ <b>Aggregated Solar PV Resource</b> ” means a resource comprised of two or more Solar PV facilities, with each such facility (i) located within the ENOI Load Zone, (ii) interconnected to the electric grid at a distribution voltage level (less than 69 kV), and (iii) having a capacity level of at least 100 kW (AC).
2	<b>Buyer:</b>	“ <b>Buyer</b> ” will be Entergy New Orleans, Inc. (“ <b>ENOI</b> ”) or its designee. For purposes of the RFP and the Definitive Agreement, Buyer will be considered an entity entirely separate and distinct from any Entergy transmission organization, and, without limiting the foregoing, the acts and omissions of any Entergy transmission organization will not be deemed to be acts and omissions of Buyer for any purpose arising out of or relating to the RFP or the Definitive Agreement.

The statements contained in this Term Sheet are made subject to the Reservation of Rights set forth in Appendix E of the RFP and the terms and acknowledgements set forth in the Proposal Submission Agreement.



**Term Sheet for Asset Acquisitions**

<b>3</b>	<b>Seller:</b>	“ <b>Seller</b> ” will be the party specified by Bidder in the applicable proposal.
<b>4</b>	<b>Facility:</b>	The “ <b>Facility</b> ,” including the nameplate capacity and major equipment, will be as specified by Bidder in the applicable proposal. For any proposal regarding an Aggregated Solar PV Resource, the term “Facility” as used in this Term Sheet will include all the facilities comprising the Aggregated Solar PV Resource.
<b>5</b>	<b>Electric Inter-connection:</b>	The “ <b>Electric Interconnection Point</b> ” will be the point (or, for an Aggregated Solar PV Resource, points) located in the ENOI Load Zone as specified by Bidder in the applicable proposal where the Facility interconnects to the host utility (and, except if the Facility is interconnected at a distribution voltage level, represented by a CP Node (the “ <b>Interconnection CP Node</b> ”)), which point is expected to be as specified by Bidder in the applicable proposal). Seller will be responsible for (and bear the full costs and risks of) the arrangement, procurement, receipt and maintenance through Closing of the interconnection, deliverability, and transmission/distribution service required for the Facility, including, without limitation, (i) the electric interconnection of the Facility to the host utility and establishment of the Electric Interconnection Point (including, as applicable, the Interconnection CP Node) and (ii) the transfer and delivery of capacity, energy, and other electric products to, and the injection of energy and other electric products at, the Electric Interconnection Point. Without limiting the foregoing, Seller will bear (a) all related interconnection, deliverability, or transmission/distribution request, application, study, registration, and comparable fees, charges, or costs, (b) all upgrade, improvement, and other fees, charges, and costs arising out of the requested interconnection, deliverability, or transmission/distribution service, except to the extent stated to be the exclusive responsibility and cost of the host utility or an applicable transmission/distribution provider, transmission/distribution owner, or Balancing Authority under the applicable tariffs, rules, regulations, or requirements of, or generator interconnection or other agreements with, the host utility or such transmission/distribution provider, transmission/distribution owner, or Balancing Authority), (c) the fees, charges, and costs to receive interconnection, deliverability, transmission/distribution service, (d) all transformer, line, energy, capacity, and other losses or costs related to the interconnection, deliverability, transmission/distribution service with respect to the Facility, and (e) all costs assigned or allocated to Seller under the applicable tariffs, rules, regulations, or requirements of, or agreements with, the host utility, transmission/distribution provider, transmission/distribution owner, or any applicable Balancing Authority. (If the resource is an Aggregated Solar PV Resource, the foregoing will apply with respect to each Electrical Interconnection Point.)

The statements contained in this Term Sheet are made subject to the Reservation of Rights set forth in Appendix E of the RFP and the terms and acknowledgements set forth in the Proposal Submission Agreement.

**Term Sheet for Asset Acquisitions**

		<p>For any Facility electrically interconnected at a transmission voltage level (69 kV and higher), as part of its responsibilities under this item 5, Seller will be required to obtain energy resource interconnection service (ERIS) and network resource interconnection service (NRIS) from MISO under the MISO OATT (or the equivalent service in the event MISO discontinues or modifies ERIS or NRIS or both, as applicable) in a quantity (a) with respect to ERIS, sufficient for the maximum generation capability of the Facility and (b) with respect to NRIS, sufficient to allow the Facility to be eligible to receive the maximum capacity credits a resource of its capacity size can receive under the MISO Rules.</p> <p>Without limiting Seller’s responsibilities set forth in the prior paragraphs of this item 5, if the Facility is interconnected at a transmission voltage level, then, at a time deemed appropriate by Buyer after execution of the Definitive Agreement with Seller, Buyer will seek to qualify the Facility as, or have the Facility recognized as, a firm designated network resource of Buyer in the applicable Balancing Authorities. Seller will be responsible and reimburse Buyer upon demand for all out-of-pocket costs incurred by Buyer in connection with Buyer obtaining, or attempting to obtain, such qualification or recognition.</p> <p>Seller will be responsible for causing Buyer to obtain directly (or, if not possible for Buyer to obtain directly, to obtain and transfer to Buyer) all auction revenue right allocations and, if applicable, financial transmission rights or congestion rights, or other similar allocations and entitlements associated with the Facility, and, if requested by Buyer, will act at Buyer’s direction in connection therewith. Without limiting the foregoing, Seller will support fully, and not take any action or position to oppose, Buyer’s receipt of such allocations and entitlements.</p> <p>If the Facility is interconnected at a distribution voltage level (less than 69 kV), (i) Seller will be required to obtain and/or maintain distribution interconnection service from the Facility to the Electric Interconnection Point in amount(s) sufficient for the maximum generation capability of the Facility, and (ii) subject to any Buyer’s instruction to the contrary in whole or in part, Seller will, at its own expense, timely execute and file all documents and take all other actions necessary or advisable to cause (1) the Facility to be qualified and/or recognized by MISO or other applicable Balancing Authority(ies) as a Load Modifying Resource (as defined in the MISO Rules) or other form of distribution-level resource recognized by MISO or such other applicable Balancing Authority(ies) and (2) Buyer to be eligible for and capable of obtaining directly all distribution entitlements and rights associated with the Facility.</p>
6	<b>Purchased Assets:</b>	<p>Buyer will acquire the Purchased Assets at the closing (if any) of the Transaction (the “<b>Closing</b>”). The “<b>Purchased Assets</b>” will include all right, title, and interest of Seller in the Facility and all related real and personal</p>

The statements contained in this Term Sheet are made subject to the Reservation of Rights set forth in Appendix E of the RFP and the terms and acknowledgements set forth in the Proposal Submission Agreement.

**Term Sheet for Asset Acquisitions**

		<p>property assets, properties, and rights, of every kind and nature, relating to, used at, or held for use at the Facility. Examples of Purchased Assets include, without limitation: all equipment, systems, fixtures, inventory (including capital and non-capital spares and fuel inventory), permits, books, records, documents, drawings (including AutoCAD), reports, logs, operating data, operating safety and maintenance manuals, inspection reports, registrations, engineering design plans, blueprints, specifications and procedures and similar items, intellectual property rights, fuel supply and transportation contracts (to the extent Buyer desires and agrees to acquire or assume the same) and related entitlements, credits, or other rights, transmission, congestion, and related entitlements, credits, or other rights, capacity credits, emissions allowances, environmental attributes, licenses, and contracts (including any long-term service agreement for the generating units) and unexpired warranties, indemnities, or guarantees related to the Facility that Buyer chooses to have assigned to it.</p>
7	<b>Purchase Price:</b>	<p>The purchase price for the Purchased Assets is expected to be based on the purchase price specified by Bidder in the applicable proposal. The purchase price will be subject to adjustment after execution of the Definitive Agreement due to (i) changes in inventory value from an agreed baseline value (including, without limitation, balance of plant inventory and capital spares), (ii) the proration of specified proratable items (e.g., property taxes, specified prepayments under project contracts acquired by Buyer at the Closing), (iii) plant performance tests described in item 15 below, (iv) amounts due but unpaid by Seller or Buyer as of the Closing, and (v) other items specified in the Definitive Agreement (the “<b>Purchase Price</b>”).</p>
8	<b>Permitted Liens; Excluded Assets:</b>	<p>Assuming occurrence of the Closing, Buyer will acquire the Purchased Assets free and clear of all encumbrances other than Permitted Encumbrances. “<b>Permitted Encumbrances</b>” means (i) liens for property taxes and other governmental charges not yet due and payable or the validity of which is being contested in good faith by appropriate proceedings described in a schedule attached to the Definitive Agreement, (ii) mechanics’, materialmens’, and other similar liens arising in the ordinary course of business by operation of law for sums not yet due and payable, up to specified cap amounts, (iii) encumbrances described in a specific schedule attached to the Definitive Agreement and that will be and are discharged or released at or before the Closing, (iv) matters expressly identified on the title commitment to which Buyer does not object, and (v) encumbrances with respect to any of the Purchased Assets created by or resulting from the acts or omissions of Buyer or the Definitive Agreement. The assets that Buyer does not agree in the Definitive Agreement to purchase at the Closing are “<b>Excluded Assets</b>” and will be excluded from the Transaction.</p>

The statements contained in this Term Sheet are made subject to the Reservation of Rights set forth in Appendix E of the RFP and the terms and acknowledgements set forth in the Proposal Submission Agreement.

**Term Sheet for Asset Acquisitions**

<b>9</b>	<b>Assumed and Excluded Liabilities:</b>	Buyer will assume certain liabilities concerning the Purchased Assets upon the Closing (“ <b>Assumed Liabilities</b> ”). The Assumed Liabilities will include only specified liabilities in respect of the Purchased Assets that relate solely to the period after the Closing and are not the result of any act or omission of Seller, any predecessor or affiliate of Seller, or any third party occurring or accruing at or prior to the Closing. Seller will retain and have exclusive responsibility for all liabilities and obligations relating to the Purchased Assets or the conduct of business of Seller, any predecessor or affiliate of Seller, or any third party other than the Assumed Liabilities assumed by Buyer upon the Closing (such liabilities and obligations, the “ <b>Excluded Liabilities</b> ”).
<b>10</b>	<b>Closing Date:</b>	The Closing will occur (i) on the first business day of the first month following the later of the month in which notice that the last outstanding condition to the Closing, other than those conditions that by their nature are to be satisfied at the Closing, has been either satisfied or waived by the Party for whose benefit such condition exist has been delivered to the other Party (subject to clause (ii)) or (ii) if the notice described in clause (i) is delivered to the other Party after the first ten (10) days of the applicable month, on the first day of the second month after such later date if such later date occurs) (the “ <b>Closing Date</b> ”). The Closing will be deemed to occur at 11:59:59 p.m. (Eastern Standard Time) on the Closing Date.
<b>11</b>	<b>Seller Representations and Warranties:</b>	The representations and warranties (“ <b>Representations</b> ”) made by Seller in the Definitive Agreement will be customary for asset acquisitions of this type by Buyer, and will include, without limitation, Representations covering compliance with laws, litigation, real, leased, and personal property, contracts, permits, warranties, intellectual property, regulatory approvals and consents, condition and sufficiency of the Purchased Assets, load-following and performance capabilities of the Facility, environmental, tax, employee, and benefits matters, insurance, regulatory status, pipeline status, NERC compliance, absence of certain changes to the Purchased Assets and absence of unspecified liabilities, and diligence-related and other matters. Seller’s Representations in the Definitive Agreement, other than Seller’s “fundamental” and environmental Representations, will survive the Closing for a period of 24 months. Seller’s fundamental Representations will survive the Closing for the applicable statute of limitations plus 30 days thereafter. Seller’s environmental Representations will survive the Closing for a period of 36 months.

The statements contained in this Term Sheet are made subject to the Reservation of Rights set forth in Appendix E of the RFP and the terms and acknowledgements set forth in the Proposal Submission Agreement.

**Term Sheet for Asset Acquisitions**

<b>12</b>	<b>Buyer Representations and Warranties:</b>	The Representations made by Buyer in the Definitive Agreement will be customary for asset acquisitions of this type by Buyer and will be limited to the organization, existence, and good standing of Buyer, execution and delivery by Buyer and enforceability of the Definitive Agreement, no violation of law, Buyer’s organizational documents, or other contracts, litigation, and Buyer’s regulatory approvals and consents. Buyer’s “fundamental” Representations will survive the Closing for the applicable statute of limitations plus 30 days thereafter. Buyer’s other Representations will survive the Closing for a period of 24 months.
<b>13</b>	<b>Covenants:</b>	The covenants (including negative covenants) and agreements in the Definitive Agreement will be customary for asset acquisitions of this type by Buyer, and will include, without limitation, covenants and agreements covering Seller’s conduct and actions taken by Seller with respect to the Purchased Assets pending the Closing, Seller’s compliance with, or execution or modification of, contracts, regulatory approvals, transfers of permits, emission allowances and contracts, title to real and personal property, risk of loss, casualty events, and material environmental conditions, insurance, taxes, employees and benefits, Seller’s non-solicitation obligations, notice and reporting obligations, maintenance of books/records, confidentiality and public announcements, removal of Excluded Assets and liens, developmental obligations, Buyer’s access to Seller’s books and records and periodic inspection rights, and technical or diligence-related matters.
<b>14</b>	<b>Purchased Capacity:</b>	The Capacity of the Facility is expected to be as specified by Bidder in the applicable proposal. For purposes of this item 14 and this Term Sheet (including the purchase price for the Purchased Assets and adjustments thereto), the Capacity of the Facility is the net electrical output that the Facility is capable of delivering reliably at the point of electric interconnection.

The statements contained in this Term Sheet are made subject to the Reservation of Rights set forth in Appendix E of the RFP and the terms and acknowledgements set forth in the Proposal Submission Agreement.

**Term Sheet for Asset Acquisitions**

<b>15</b>	<b>Plant Performance Testing:</b>	The Definitive Agreement will provide for a test of the performance of the Facility, including the individual generating units, to be conducted, at Seller’s expense, to determine, in connection with the Closing. The test will cover (i) Capacity, and (ii) other plant performance metrics and criteria set forth in the Definitive Agreement, including, without limitation, diligence-related items. The results of the test of items (i) and, if applicable, (ii) above will be compared against the corresponding values specified in the Definitive Agreement. The test will be conducted within a specified period prior to the target Closing Date pursuant to an agreed protocol. Subsequent tests may be required depending on the results of the previous performance test, intervening events or circumstances, and/or modifications to the target Closing Date. Unless Buyer otherwise directs, each subsequent test will be performed by the contractor that performed the initial test. Final test results may give rise to a reduction in the Purchase Price or termination of the Definitive Agreement. Seller will not be entitled to any increase in the Purchase Price or any other compensation from Buyer if the test results indicate that performance for a particular metric or criteria is better than that required by the Definitive Agreement.
<b>16</b>	<b>Buyer’s Closing Conditions:</b>	Buyer’s obligation to Close the Transaction will be subject to the satisfaction or express waiver by Buyer of certain conditions to be specified in the Definitive Agreement and customary for asset acquisitions of this type by Buyer, including, without limitation, conditions related to federal, state, and, if applicable, local regulatory and governmental approvals (“ <b>Regulatory Approvals</b> ”), expiration or termination of waiting periods under the Hart-Scott-Rodino Antitrust Improvements Act of 1976, as amended (“ <b>HSR Act</b> ”), if applicable, Buyer consents, the correctness of Seller’s Representations, performance of and compliance with Seller covenants, obligations, and agreements in the Definitive Agreement or Ancillary Agreements on or before the Closing, specified Seller certifications and documents and items, the absence of a material adverse effect with respect to Seller, title insurance, eminent domain, capacity accreditation (including, without limitation, the transfer of capacity credits to Buyer for the planning period beginning no later than June 1, 2020) and transmission/distribution service (including, without limitation, applicable firm network resource and deliverability qualifications and transmission and congestion rights), the operation and maintenance agreement(s) for any of the Purchased Assets, plant performance test results, credit support, and, if applicable, achievement of commercial operation and payment of amounts due in connection therewith. There will be a defined period from the effective date of the Definitive Agreement for the Buyer closing conditions to be satisfied.
<b>17</b>	<b>Seller’s Closing Conditions:</b>	Seller’s obligation to Close the Transaction will be subject to the satisfaction or express waiver, by Seller, of certain conditions to be specified in the Definitive Agreement, including, without limitation, conditions related to certain Regulatory Approvals, expiration or termination of waiting periods

The statements contained in this Term Sheet are made subject to the Reservation of Rights set forth in Appendix E of the RFP and the terms and acknowledgements set forth in the Proposal Submission Agreement.

**Term Sheet for Asset Acquisitions**

		<p>under the HSR Act, required Seller consents, the correctness of Buyer’s Representations, performance of and compliance with Buyer covenants, obligations, and agreements in the Definitive Agreement or Ancillary Agreements on or before the Closing, and specified Buyer certifications and documents and items. There will be a defined period from the effective date of the Definitive Agreement for the Seller closing conditions to be satisfied.</p>
<p><b>18</b></p>	<p><b>Durability of Regulatory Approvals/ Alternate Acquisition Structures:</b></p>	<p>Seller will take the risk that a Regulatory Approval or, if applicable, expiration or termination of a waiting period under the HSR Act ceases to be valid and effective as of the time the Closing would otherwise occur (<i>e.g.</i>, because the Facility construction schedule exceeds the term of validity and effectiveness of such Regulatory Approval or such expiration or termination). In the event Seller proposes an alternative acquisition structure that is accepted by Buyer as the basis for the Transaction, the Definitive Agreement will reflect terms agreed upon by the parties as appropriate for the alternative acquisition structure.</p>
<p><b>19</b></p>	<p><b>Commercial Operation Date</b>  {For Developmental Resources Only}:</p>	<p>The date by which the COD must occur is expected to be the date specified as such by Bidder in the proposal (as such date may be extended on a day-for-day basis, up to a maximum of 180 days in the aggregate, to the extent that the COD is delayed as a result of Force Majeure, the “<b>Guaranteed COD</b>”). The definition of “<b>Commercial Operation Date</b>” or “<b>COD</b>” will be specified in the Definitive Agreement, but, in general, will require, among other things, that the Facility has achieved substantial completion, satisfied certain performance tests, and be available for normal continuous operation; that the interconnection, metering, telemetry, and certain other equipment and systems be installed, tested, and properly working; and that Seller be in compliance with the Definitive Agreement and ancillary/project agreements, have in full force and effect all required permits, authorizations, waivers, and agreements, have in place certain accounts and registrations, have provided to Buyer all required credit support and evidence of insurance coverage, made all arrangements for the supply of required electric services and other utilities to the Facility, and completed staffing and required training of Seller’s personnel and representatives. In the event the Commercial Operation Date does not occur by the Guaranteed COD, Seller will be subject to, among other things, delay damages, potential capacity re-sizing and “buy-downs” required by Buyer, and, for extended delays, potential termination of the Definitive Agreement. (For more detailed descriptions and treatments of the COD and the consequences of a failure to meet the Guaranteed COD, please see item 28 in Appendix B-1, the terms of which should be substantially similar to the terms that will apply to a Definitive Agreement for an Asset Acquisition Product.) The Definitive Agreement will include a project schedule with numerous project milestones. Seller will be required to provide to Buyer periodic progress reports and inspection and other rights related to the pre-</p>

The statements contained in this Term Sheet are made subject to the Reservation of Rights set forth in Appendix E of the RFP and the terms and acknowledgements set forth in the Proposal Submission Agreement.

**Term Sheet for Asset Acquisitions**

		commercial operation phase of development and immediate notice when the Commercial Operation Date has occurred.
<b>20</b>	<b>Indemnification:</b>	The Definitive Agreement will contain indemnification provisions customary for asset acquisitions of this type by Buyer and will include, without limitation, (i) an aggregate cap on the liabilities of Seller or Buyer for the inaccuracy or breach of any Representation of Seller or Buyer (other than a “fundamental” Representation), (ii) full indemnity protection ( <i>i.e.</i> , the threshold and cap do not apply) for any and all liabilities and obligations retained by Seller or with respect to the breach of any covenant, agreement, or obligation by either Party or a “fundamental” Representation being incorrect or inaccurate, (iii) a provision entitling each Party to rely on the Representations, covenants, obligations, and agreements of the other Party notwithstanding any investigation or audit conducted (or that could have been conducted) or any information received or knowledge obtained (or that could have been received or obtained) or the decision of a Party to complete the Closing, and (iv) any qualification or limitation set forth in a Representation, covenant, or agreement as to materiality or material adverse effect (or words of similar effect) contained therein will be disregarded for purposes of the indemnity.
<b>21</b>	<b>Termination Rights:</b>	The Definitive Agreement will include termination rights customary for acquisitions of this type by Buyer.  { <i>For Developmental Resources</i> } The Definitive Agreement may include rights in favor of Buyer to terminate the Definitive Agreement for convenience after the satisfaction or waiver of Buyer’s conditions. If Buyer terminates the Definitive Agreement pursuant to such rights, as Seller’s sole remedy arising out of such termination, Buyer will be required to pay to Seller a pre-agreed amount to be set forth in a schedule to the Definitive Agreement to be negotiated between Buyer and Seller. The amounts set forth in such schedule will vary according to when such termination occurs and will not exceed the actual, direct out-of-pocket costs reasonably incurred by Seller to terminate construction (or, if less, to complete construction and make alternate use) of the Facility at such time and the financing thereof. Seller will be required to use commercially reasonable efforts to minimize any such actual, direct out-of-pocket costs.
<b>22</b>	<b>Operation &amp; Maintenance Preparedness:</b>	Seller will fully cooperate, and cause its Affiliates and third-party operators, contractors, and representatives to fully cooperate, with Buyer in order to enable Buyer (or any Affiliate, contractor, or representative of Buyer) to become reasonably familiar with the Purchased Assets as of the Closing and be in a reasonable position to operate and maintain the Purchased Assets immediately upon the Closing as a reasonable prudent operator of the Purchased Assets.

The statements contained in this Term Sheet are made subject to the Reservation of Rights set forth in Appendix E of the RFP and the terms and acknowledgements set forth in the Proposal Submission Agreement.



**Term Sheet for Asset Acquisitions**

<b>23</b>	<b>Certain Transaction Expenses:</b>	<p>Except as otherwise provided in the Definitive Agreement or a related agreement between the Parties, the Party incurring costs in connection with the Transaction will be responsible for paying them. The Definitive Agreement will allocate certain costs to a Party or the Parties. Transaction costs expressly allocated to Seller are expected to include, without limitation, (i) transfer or similar taxes, (ii) contract (including license) or document transfer, consent, or conveyance or assignment fees or similar charges or costs, if any, including taxes, and (iii) filing and/or recording costs, fees, or similar charges with respect to the transfer of real property from Seller to Buyer. Transaction costs expressly allocated to Buyer are expected to include, without limitation, permit transfer or assignment fees or similar permit conveyance charges or costs, if any, including taxes. Seller and Buyer will each bear one-half of the amounts charged by the environmental consultant retained at Buyer’s direction in connection with the environmental assessment of the real property interests to be conveyed to Buyer at the Closing and the filing fee payable in connection with any notifications filed under the HSR Act with respect to the Transactions.</p>
<b>24</b>	<b>Management Approval:</b>	<p>The Definitive Agreement is subject to review and concurrence or approval, as applicable, by the corporate risk office of Entergy Corporation, the board of directors of Buyer, the executive and senior management of Entergy Corporation and Buyer, and such other approvals of Entergy Corporation and its affiliates as Buyer deems necessary or prudent in its sole and absolute discretion to enter into the Definitive Agreement and perform its obligations thereunder (on the terms set forth therein). Buyer will not execute or deliver the Definitive Agreement without such review and concurrence or approval, as applicable, and such approval or concurrence may be granted or denied in each such body’s sole and absolute discretion.</p>
<b>25</b>	<b>Select Contract Terms and Conditions:</b>	<p>The Definitive Agreement will also include, among other things, the following covenants, terms, and/or conditions:</p> <ul style="list-style-type: none"> <li>• Seller will insure, develop, engineer, procure equipment for, design, construct, install, operate, maintain, manage, replace, repair, study, test, and otherwise use the Facility in accordance with (i) Seller’s obligations in the Definitive Agreement, the Facility’s interconnection agreements, and the other project documents, (ii) accepted electrical practices, and (iii) all applicable laws (including environmental laws), consents, and governmental approvals, including all applicable standards and guidelines adopted from time to time by governmental authorities (including NERC, SERC Reliability Corporation, any RTO and any comparable third party with the right to impose on the Facility or Seller conditions or obligations having the effect of an applicable law or other binding legal requirement); and</li> </ul>

The statements contained in this Term Sheet are made subject to the Reservation of Rights set forth in Appendix E of the RFP and the terms and acknowledgements set forth in the Proposal Submission Agreement.

**Term Sheet for Asset Acquisitions**

		<ul style="list-style-type: none"><li>• Seller will insure against all insurable risks with coverage in an amount not less than full replacement cost and on terms specified in the Definitive Agreement.</li></ul>
<b>26</b>	<b>Credit Support:</b>	Seller will be expected to meet the credit support requirements detailed in the RFP, including Appendix F, and other credit-related terms, all of which will be more fully developed in the Definitive Agreement.
<b>27</b>	<b>Confidentiality:</b>	Each Party will be required to keep the terms and provisions of the Definitive Agreement confidential and prohibited from disclosing such terms to any third party, subject to certain limited exceptions specified in the Definitive Agreement.

The statements contained in this Term Sheet are made subject to the Reservation of Rights set forth in Appendix E of the RFP and the terms and acknowledgements set forth in the Proposal Submission Agreement.

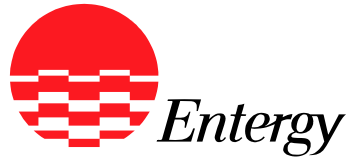

## ***Appendix C-1***

***Preliminary Due Diligence List  
(Developmental Resources)  
For  
2016 Request For Proposals  
For  
Long-Term Renewable  
Generation Resources  
For  
Entergy New Orleans, Inc.***

Entergy Services, Inc.  
July 13, 2016

The statements contained in this RFP are made subject to the Reservation of Rights set forth in Appendix E of this RFP and the terms and acknowledgements set forth in the Proposal Submission Agreement.

**APPENDIX C-1  
PRELIMINARY DUE DILIGENCE LIST  
(DEVELOPMENTAL RESOURCES)**

Bidders that intend to submit a proposal in the RFP based upon a Developmental Resource must provide a comprehensive response to each question set forth in this Appendix C-1. Bidders should respond to any question that does not apply to the proposed Developmental Resource with an “N/A” or “not applicable.” **Bidders must respond to each question by 5:00 pm CPT on the Proposal Submission Deadline.** Bidders are required to submit their response to the questions below in writing in such a way that clearly identifies the question to which each response pertains, and then provide the response via electronic mail or express delivery to the RFP Administrator.

Failure to submit a response to a question as required will increase the likelihood of a Bidder’s proposal being rejected as non-conforming and rejected from further consideration. Failure to provide a comprehensive response could negatively affect a proposal’s overall viability ranking. Bidders should keep in mind that this Appendix C-1 is not a prescriptive list of requirements for its proposed resource, but instead is a list of items that RFP Evaluation Teams will use to assess the viability of individual projects. Any item requested in this Appendix C-1 that is not available, not presently known, or not otherwise provided by Bidder may count against its final viability score, but will not necessarily, in and of itself, cause its proposal to be declared non-conforming.

**1. Project Overview**

- 1.1 Provide a thorough summary description of the project, including, but not limited to, the proposed location, site description, technology, nameplate capacity, and the capacity of the proposed resource, design basis, water source(s), if applicable, plan for engineering/procurement/construction, interconnection status, financing plan, O&M plan, and non-standard project components/considerations, as well as a summary of the work completed on each of the minimum requirements described herein.
- 1.2 Provide Bidder’s/Seller’s operation and maintenance expectations and philosophy for the project after project completion, including, without limitation, the use of any third-party operator and any long-term service agreement with respect to any of the plant equipment. Anything provided in the summary should not otherwise limit Bidder’s response to any of the requirements below.

**2. Bidder Experience**

- 2.1. Provide a detailed description of Bidder’s background and experience, including a list of sites where Bidder has built, operated, and/or maintained a project utilizing the technology included in Bidder’s proposal, including year(s) of installation, size, major equipment make and model information, and operational success.

The statements contained in this RFP are made subject to the Reservation of Rights set forth in Appendix E of this RFP and the terms and acknowledgements set forth in the Proposal Submission Agreement

**APPENDIX C-1**  
Preliminary Due Diligence List (Developmental Resources)

- 2.2. Include any Affiliated companies, parent company, holding subsidiaries or predecessor companies; include resumes of key personnel dedicated to the project.
- 2.3. In detail, describe Bidder's experience within MISO or other RTO markets.
- 2.4. Provide a list and summary of all power supply contracts (including ancillary services) to which Bidder is a party.
- 2.5. Provide one (1) or more utility-scale project references completed and/or under development.
  - 2.5.1. Include details of project schedules, historical performance and operating history

**3. Project Development**

- 3.1. Engineering
  - 3.1.1. Has a preliminary design study been performed for the resource? If so, provide the study. If not, when is this activity expected to be completed?
  - 3.1.2. Has a detailed engineering study been performed for the resource? If so, provide the study. If not, when is this activity expected to be completed?
  - 3.1.3. Have operation and maintenance budget estimates been established for the resource under each of the following categories?:
    - 3.1.3.1. Variable O&M costs
    - 3.1.3.2. Fixed O&M costs – labor, maintenance materials, overhead burden, insurance, extraordinary maintenance, property taxesIf so, provide the supporting information reflecting the budget estimates for the categories above. If not, when are these activities expected to be completed?
  - 3.1.3.3. Provide the O&M plan for the project
  - 3.1.4. If applicable, have heat balance, material balance, or process flow diagrams been developed? If so, provide the supporting information, such as the flow diagrams, etc. If not, when is this activity expected to be completed?
  - 3.1.5. Have auxiliary power and behind-the-fence requirements been established? If so, provide the supporting information such as the amount and drivers of aux load and behind-the-fence load. If not, when is this activity expected to be completed?
  - 3.1.6. What design criteria were used for the following?:
    - 3.1.6.1. Architectural?
    - 3.1.6.2. Civil Structural?
    - 3.1.6.3. Controls and Instrumentation?
    - 3.1.6.4. Electrical?
    - 3.1.6.5. Mechanical?Provide supporting information, such as the design codes and summary descriptors. If design criteria have not been completed, when are they expected to be completed?

The statements contained in this RFP are made subject to the Reservation of Rights set forth in Appendix E of this RFP and the terms and acknowledgements set forth in the Proposal Submission Agreement

**APPENDIX C-1**  
Preliminary Due Diligence List (Developmental Resources)

- 3.1.7. Has the design basis been established for the facility site plan, including the following?:
- 3.1.7.1. General arrangement
  - 3.1.7.2. Road and rail access
  - 3.1.7.3. Water supply (if applicable)  
If so, provide the supporting information, such as would be included in an engineering study. If not, when are these activities expected to be completed?
- 3.1.8. Has the architectural design basis been established? If so, provide the supporting information, such as a summary of the design basis and corresponding documentation. If not, when is this activity expected to be completed? Confirm that all state and local building codes will be met.
- 3.1.9. Has the civil structural design basis been established for the following:
- 3.1.9.1. Foundations?
  - 3.1.9.2. Proposed loads?
  - 3.1.9.3. Design codes and materials?
  - 3.1.9.4. Structural steel?
  - 3.1.9.5. Roads?
  - 3.1.9.6. Drainage?
  - 3.1.9.7. Solid waste disposal area (if applicable)?  
If so, provide the supporting information, such as would be included in an engineering study. If not, when are these activities expected to be completed?
- 3.1.10. Has the design basis been established for controls and instrumentation, including the distributed control system and functional logic diagrams? If so, provide the supporting information. If not, when is this activity expected to be completed? Will the facility be designed and equipped to operate under automatic generation control?
- 3.1.11. Have the electrical design basis and specifications been established, including single line diagram and electrical system descriptions? If yes, provide the supporting information, such as the diagrams and descriptions. If not, when is this activity expected to be completed?
- 3.1.12. Has the design basis been established for mechanical design, including the following?:
- 3.1.12.1. Major equipment/components
  - 3.1.12.2. Control systems
  - 3.1.12.3. Auxiliary equipment  
If so, provide the supporting information, such as would be included in an engineering study. If not, when are these activities expected to be completed?
- 3.1.13. Has the design basis been established for balance of plant equipment? If so, provide the supporting information, such as would be included in an engineering study. If not, when is this activity expected to be completed?
- 3.1.14. Does the design contemplate a behind-the-meter generation (BTMG) arrangement?
- 3.1.15. List and describe the licenses and other authorizations required under applicable rules, regulations, and other laws, including Louisiana R.S. 37:2150-2192, Section 319, including (if applicable), without limitation, any required solar classification license.

The statements contained in this RFP are made subject to the Reservation of Rights set forth in Appendix E of this RFP and the terms and acknowledgements set forth in the Proposal Submission Agreement

**APPENDIX C-1**  
Preliminary Due Diligence List (Developmental Resources)

3.2. Project Schedule

- 3.2.1. Has a detailed construction schedule been developed? If so, provide the schedule. If not, answer the following questions:
- 3.2.1.1. When is this activity expected to be completed?
  - 3.2.1.2. Has a summary level construction schedule been developed? If so, provide the schedule. If not, when is this activity expected to be completed?
  - 3.2.1.3. Has a project master schedule been developed that includes major construction milestone dates? Examples of such milestones should include, but are not limited to:
    - 3.2.1.3.1. Receipt of Major Permits
    - 3.2.1.3.2. Limited Notice to Proceed (if applicable)
    - 3.2.1.3.3. Financial Close
    - 3.2.1.3.4. Full Notice to Proceed
    - 3.2.1.3.5. Major Equipment Purchases
    - 3.2.1.3.6. Site Mobilization
    - 3.2.1.3.7. Delivery of Major Equipment
    - 3.2.1.3.8. Mechanical Completion
    - 3.2.1.3.9. Substantial Completion
    - 3.2.1.3.10. Commercial OperationIf so, provide the schedule or project timeline. If not, when are these activities expected to be completed?
- 3.2.2. How much time has been allowed in the construction schedule for resolving unforeseen operations problems?
- 3.2.3. Have permits for construction been obtained? If so, provide a copy of the permit(s). If not, when is this activity expected to be completed?
- 3.2.4. Has a construction project team been assembled? If not, when is this activity expected to be completed?
- 3.2.5. For Aggregated Solar PV Resources: How much time has been scheduled to allow for execution of multiple site agreements?

3.3. Cost Estimate

- 3.3.1. Provide a description of the current capital cost estimate for the project, including the following:
- 3.3.1.1. Indication of the accuracy of the estimate using an appropriate cost estimate classification system (*e.g.*, Class 1 through Class 5).
  - 3.3.1.2. How the estimate was developed (*e.g.*, third party engineering firm, in-house, vendor supplied bids, etc.)? At a minimum, estimates should account for the following:
    - 3.3.1.2.1. Generation equipment (*e.g.*, wind turbines, solar panels, inverters, hydro turbines, etc.)
    - 3.3.1.2.2. Mechanical and electrical equipment
    - 3.3.1.2.3. Instrumentation and controls
    - 3.3.1.2.4. Miscellaneous buildings

The statements contained in this RFP are made subject to the Reservation of Rights set forth in Appendix E of this RFP and the terms and acknowledgements set forth in the Proposal Submission Agreement

**APPENDIX C-1**  
Preliminary Due Diligence List (Developmental Resources)

- 3.3.1.2.5. Major commodities (*e.g.*, steel, copper, etc.)
- 3.3.1.2.6. Site work and foundations
- 3.3.1.2.7. Retrofit allowance (if applicable)
- 3.3.1.2.8. Sales tax
- 3.3.1.2.9. Engineering costs
- 3.3.1.2.10. Indirect costs
- 3.3.1.2.11. Spare parts
- 3.3.1.2.12. Escalation and AFUDC/IDC
- 3.3.1.2.13. Construction finance costs
- 3.3.1.2.14. Any other category not listed here and reasonably expected to be included for the proposed technology

3.4. Site Control and Assessment

- 3.4.1. Describe the status of the proposed project site, including the following:
  - 3.4.1.1. Site control – Is the proposed site under the legal control of Bidder and, if so, under what legal form? If the site is not currently under the legal control of Bidder, describe the process required to gain control and provide an assessment of the risk related to gaining control of the site.
  - 3.4.1.2. Has the proposed site been formally assessed for risks related to environmental contamination, habitat, or other pre-existing conditions that may render the site unusable or delay or otherwise impair or adversely affect development? Provide the executive summary of any formal reports. If the site has not been formally assessed, what supporting facts or actions provide assurance that the site is fit for the intended use?
  - 3.4.1.3. Indicate what construction related surveying or testing has been performed at the site. Summarize the results.
  - 3.4.1.4. Is the proposed project site within a floodplain? If so, please identify the designated zone and the corresponding level of exposure.
  - 3.4.1.5. Is there a storm water mitigation plan in place for the current proposed site? Please include the details of the plan and mitigation controls.
  - 3.4.1.6. For rooftop Solar PV projects, has a structural site assessment been performed to assess the ability of the proposed site to support any installed equipment (*e.g.*, solar panels, inverters, etc.)? If so, provide all available results of the site assessment.
  - 3.4.1.7. Are any easements or variances required with regard to the site?
- 3.4.2. Describe the status of any necessary site infrastructure, including, but not limited to:
  - 3.4.2.1. Water supply
  - 3.4.2.2. Water discharge
  - 3.4.2.3. Transportation access for construction activities and ongoing operations
  - 3.4.2.4. Lay down area access for construction
- 3.4.3. Provide the following details regarding the proposed site:
  - 3.4.3.1. Describe the exact location (*i.e.*, street address or latitude and longitude if in a rural location)

The statements contained in this RFP are made subject to the Reservation of Rights set forth in Appendix E of this RFP and the terms and acknowledgements set forth in the Proposal Submission Agreement



**APPENDIX C-1**

Preliminary Due Diligence List (Developmental Resources)

- 3.4.3.2. Provide a property plat if available
- 3.4.3.3. Acreage as planned
- 3.4.3.4. Other available acreage adjacent to the site

3.5. Facility and Equipment

- 3.5.1. Describe the facility and equipment to be utilized in as much detail as available. Describe the status of the procurement of major equipment. If the procurement of the facility and equipment is not yet complete, provide details of the procurement plans.
- 3.5.2. For each piece of major equipment, provide the make, model, and performance rating.
- 3.5.3. Provide the rationale for the selection of the major equipment, including a description of the procurement process used.
- 3.5.4. Provide an equipment list for other equipment to be utilized at the site.
- 3.5.5. Discuss the viability of the proposed technology, the operational reliability, and the experience, industry standing, and creditworthiness of the manufacturer.
- 3.5.6. Discuss the warranty of the major components.
- 3.5.7. Discuss and provide published reports demonstrating the proposed technology is commercially proven.
- 3.5.8. Operational characteristics
  - 3.5.8.1. If applicable, has a solar radiation index, etc. study been performed for the proposed site? If so, specify the data source, the length/duration of the data made available by the data source, and explain the results and how the results support the projected annual MWh.
  - 3.5.8.2. Provide an expected hourly generation profile and a detailed explanation as to how it was derived. If available, include supporting meteorological data from satellite, onsite, or nearby ground-mounted data measurement devices and/or a third-party resource assessment study. Preferably, the profile should be based upon two (2) or more recent years of onsite meteorological data, to the extent available. A template is or will be included in the Proposal Submission Template posted on the RFP Website for Bidders to use in response to this requirement.
  - 3.5.8.3. Explain the source of information, resource data measurement method used, assumptions for any equipment/transmission/etc. losses, and the location where the data was measured. Did a third party subject matter expert prepare the reports associated with the data? If so, who? Describe the risk of basing the generation calculations on the data. Describe the technical challenges relative to the project's scale not related to the development of the core technology (i.e., manufacturing capacity of supplier production, complexity of deployment processes, etc.).
  - 3.5.8.4. Provide P50, P75, P90 and P99 annual generation levels for each year of the term of the proposal and the methodology and supporting documentation for the determination of such generation levels.
  - 3.5.8.5. Provide a description of the various modes of operation of the resource.
  - 3.5.8.6. Provide the minimum and maximum load range in each mode of operation.

The statements contained in this RFP are made subject to the Reservation of Rights set forth in Appendix E of this RFP and the terms and acknowledgements set forth in the Proposal Submission Agreement

## APPENDIX C-1

### Preliminary Due Diligence List (Developmental Resources)

- 3.5.8.7. Provide the maximum ramp rates over the load range for each mode of operation.
  - 3.5.8.8. Provide the MVAR capability range of the resource; include “as tested results.”
  - 3.5.8.9. Will the unit be equipped with automatic generation control (AGC)?
  - 3.5.8.10. What will be the operating range of the resource under AGC?
  - 3.5.8.11. What other electric products is the resource expected to be capable of providing?
  - 3.5.8.12. For wind resources, describe any expected sector management requirements.
  - 3.5.8.13. For Solar PV resources, describe the type of inverter/s that will be used.
- 3.5.9. Indicate whether the resource will be registered as a small power production facility with QF status.
- 3.6. Operations and Maintenance
- 3.6.1.1. Describe the operation and maintenance plans for the project including the following:
    - 3.6.1.2. Expected operating party (self-operated, third-party contract, etc.).
    - 3.6.1.3. Provide the qualifications of the expected operating party if not included in the response to question 2.1 above.
    - 3.6.1.4. If expected to be operated under contract, provide a description of the expected contract, including term, scope, pricing structure, liability provisions, etc.
    - 3.6.1.5. Describe any contracts for maintenance not expected to be performed by the operating party.
    - 3.6.1.6. Provide the anticipated major maintenance schedule for the project by year for the lower of the life of the project or anticipated PPA term.
- 3.7. Capacity-Related Benefits
- 3.7.1. Identify any benefits associated with the capacity of the resource offered to Buyer, including any capacity credits or similar rights or benefits for which the resource is expected to be eligible and provide the basis for that belief.
  - 3.7.2. Describe any studies or other actions needed to qualify the resource for capacity-related benefits and the status and any results of any such studies or actions.
- 3.8. Other Commitments
- 3.8.1. If applicable, provide a detailed description of any and all expected commitments of energy, capacity, capacity-related benefits, other electric products and environmental attributes of the resource other than those contemplated by Bidder’s proposal in the RFP.
  - 3.8.2. If applicable, confirm the offered capacity can be separately metered and operated as a separate resource into MISO markets.

The statements contained in this RFP are made subject to the Reservation of Rights set forth in Appendix E of this RFP and the terms and acknowledgements set forth in the Proposal Submission Agreement

**APPENDIX C-1**  
Preliminary Due Diligence List (Developmental Resources)

3.8.3. If applicable, describe how the output of the resource will be allocated between or among multiple offtakers (*e.g.*, dedicated units to each offtaker, pro rata, etc.) and how the market participant role is expected to be handled under such circumstances.

**3.9. Contract Status**

3.9.1. Is there an EPC contract in place for the resource? If so, identify the EPC contractor and the EPC pricing structure. If not, answer the following questions:

3.9.1.1. When is such an EPC contract expected to be executed?

3.9.1.2. Is there a letter of intent in place with an EPC provider?

3.9.1.3. If no such letter of intent is in place, have proposals been requested from possible EPC providers?

3.9.1.4. Provide the EPC pricing structure contemplated for the project.

3.9.2. If Bidder does not intend to use a traditional EPC contract for the resource, provide the following information and answer the following questions:

3.9.2.1. Describe contracting methodology.

3.9.2.2. Are contracts in place for all major work (*e.g.*, construction/construction management, equipment supply, civil scope, electrical scope)? If so, provide supporting documentation as well as the pricing structure. If not, answer the following questions:

3.9.2.2.1. When is this activity expected to be completed?

3.9.2.2.2. Are there letters of intent in place with such providers?

3.9.2.2.3. If no such letters of intent are in place, have proposals been requested from providers of such services?

3.9.2.2.4. Provide the pricing structure contemplated for a definitive agreement.

3.9.2.3. Are contracts in place for cost and schedule control? If not, when is this activity expected to be completed?

3.9.3. Are contracts in place for the following matters:

3.9.3.1. Project scoping?

3.9.3.2. Design engineering?

3.9.3.3. Support of permitting?

3.9.3.4. Major equipment purchase?

3.9.3.5. Long-term service agreements (if applicable)?

3.9.3.6. Other?

If so, provide supporting information, such as a summary description of those contracts.

If not, when are these activities expected to be completed?

**4. Electric Interconnection**

**4.1. Transmission Interconnection/Deliverability**

4.1.1. If the resource will be directly interconnected to the MISO System, provide the complete copy of the submitted interconnection application (including for the quantities of ERIS and NRIS required by the RFP), a copy of either the MISO letter acknowledging the application or, if available, the actual study results related to such

The statements contained in this RFP are made subject to the Reservation of Rights set forth in Appendix E of this RFP and the terms and acknowledgements set forth in the Proposal Submission Agreement

**APPENDIX C-1**  
Preliminary Due Diligence List (Developmental Resources)

- application and the associated MISO queue number as described in the first paragraph in Section 2.4.2 of the Main Body.
- 4.1.2. If the resource will not be directly interconnected to the MISO System, provide the complete copy of the appropriate interconnection service application(s) and a copy of any acknowledgement letter (or similar document) from the applicable Balancing Authority or transmission authority as described in the second paragraph in Section 2.4.2 of the Main Body.
  - 4.1.3. Provide any information regarding land options, land purchase agreements, permits, etc. required to complete the installation of the interconnection facilities (*e.g.*, transmission or distribution line rights-of-way).
  - 4.1.4. What is the approximate distance to the nearest transmission-level substation location (115kv or above) (provide the substation name or a description of its location, if possible) and voltage rating of the generation interconnection for the resource?
  - 4.1.5. Provide the status and details of the generation interconnection request (interconnection point, requested and (if known) granted interconnection capacity (*e.g.*, PMax), network vs. energy only, etc.) and the associated interconnection queue number, if any.
  - 4.1.6. Have results of any required interconnection study been provided?
  - 4.1.7. Has an interconnection agreement or related agreement for the resource been executed? Describe any transmission or network upgrades that have been identified with respect to the interconnection application (inclusive of any request for both ERIS and NRIS) and the expected timeframe and estimated cost for completion of each such upgrade.
- 4.2. Transmission, Transmission Upgrades, and Network Resource Interconnection Service
- 4.2.1. Provide the status and details of any request for (i) if the resource will be directly interconnected to the MISO System, NRIS and the associated MISO transmission reservation queue number, or (ii) if the resource will not be directly interconnected to the MISO System, firm point-to-point transmission service from the resource to the MISO South portion of the MISO System.
  - 4.2.2. Has a transmission study been initiated for the resource or for transmission service from the resource? If so, provide a reasonably detailed summary of the results.
  - 4.2.3. Has an interconnection service or related agreement been executed for the resource?
  - 4.2.4. Provide Bidder's current expectations regarding any upgrades required in connection with requests for interconnection, deliverability, and/or transmission service and related costs thereof.
  - 4.2.5. If applicable, provide a copy of each acknowledgement letter (or similar document) from the Balancing Authority or transmission authority with regard to any deliverability or transmission service application or request regarding power offered to ENOI under the proposal.

4.3. Distribution Interconnection

The statements contained in this RFP are made subject to the Reservation of Rights set forth in Appendix E of this RFP and the terms and acknowledgements set forth in the Proposal Submission Agreement

**APPENDIX C-1**  
Preliminary Due Diligence List (Developmental Resources)

- 4.3.1. For resources that will be interconnected at a distribution voltage level (less than 69 kV) within the ENOI Load Zone, provide any completed copy of the interconnection application submitted to Entergy's Distribution group. For Aggregated Solar PV Resources, include the applications for each site.
- 4.3.2. List the proposed project sites with the desired interconnection capacity amount at each site.
- 4.3.3. List the proposed feeder connections that correspond to the site locations listed above and the corresponding distance from the feeder.
- 4.3.4. Provide any responses/acknowledgement letter from Entergy's Distribution group.
- 4.3.5. Provide Bidder's current expectations regarding any upgrades required in connection with the proposed distribution interconnection.
- 4.3.6. Is there an existing interconnected generator at the proposed site(s) for the resource?
- 4.3.7. Will the resource isolate from the host utility upon a total loss of electric service or a loss of any individual phase circuit?
- 4.3.8. Will the resource be capable of supplying reactive power (VARs)?
- 4.3.9. Provide the voltage for 3-phase delivery at the proposed interconnection point(s).
- 4.3.10. Will the resource disconnect inertia within 10 cycles of a service interruption or fault?
- 4.3.11. Will the resource be blocked from energizing dead circuits?
- 4.3.12. Provide the short circuit current for the entire generation system.
- 4.3.13. Provide any available drawings of the resource's interconnection facilities, including a one line diagram and proposed relay systems.
- 4.3.14. List the specifications on applicable protective devices, inverter and power quality revenue meter.
- 4.3.15. Provide a layout sketch showing lockable, "visible" disconnect device for hot and neutral circuits.

**5. Environmental**

- 5.1. Land/Groundwater
  - 5.1.1. Have the previous land uses for the resource/site been identified? If so, list those uses or provide the supporting information.
  - 5.1.2. Have any potentially contaminating activities at nearby facilities/sites been identified? If so, list and describe those identified.
  - 5.1.3. Has an environmental impact study been conducted for the resource/site? If so, provide a copy of the study.
  - 5.1.4. If applicable, provide the number of groundwater monitoring or production wells at the facility/site and provide copies of state registrations for each well.
  - 5.1.5. Does documentation exist on the details of the geological and hydrogeological nature of the soil and groundwater underneath the resource/site? If so, provide the supporting information.
  - 5.1.6. Has a wetlands survey been completed for the proposed site? Have any potential wetlands been identified on the property? Provide a copy of any completed wetlands surveys of the property (including desktop reviews and on-site surveys).

The statements contained in this RFP are made subject to the Reservation of Rights set forth in Appendix E of this RFP and the terms and acknowledgements set forth in the Proposal Submission Agreement

**APPENDIX C-1**  
Preliminary Due Diligence List (Developmental Resources)

5.2. Permitting

- 5.2.1. Provide a list of all environmental permits required by the project owner or operator or any of its Affiliates. Provide a copy of any permits received for the project to date.
- 5.2.2. Provide evidence that it has completed all permitting due diligence necessary to prepare to apply for all required permits (*e.g.*, a copy of the draft permit application(s), or a summary of the permit application requirements including how those requirements will be met).
- 5.2.3. Bidder must provide a “Phase I” environmental site assessment according to ASTM E1527 or evidence and documentation of due diligence specific to the proposed site necessary and sufficient to support such an assessment (*e.g.*, documentation of work necessary to meet the primary components required under a Phase I according to ASTM E1527).
- 5.2.4. Bidder must disclose any reasonably anticipated permitting obstacles and any pending claims, actions, or disputes related to permitting activities completed to date.

5.3. Noise/Federal Aviation Administration/Department of Defense/Avian/Wetlands/  
Endangered Species

- 5.3.1. Has the site or facility been evaluated to determine concerns or needs related to construction required for the project in connection with compliance with any applicable noise, Federal Aviation Administration, Department of Defense, avian, wetlands, or endangered species regulations? If so, state any special concerns or limitations and note whether any regulatory compliance activity has been undertaken by the project owner or submitted to any governmental agency.
- 5.3.2. If applicable, what are the anticipated or current controls for noise?
- 5.3.3. Identify the location of the nearest residence.
- 5.3.4. Identify the location of the nearest business.

5.4. Water

- 5.4.1. If material to the operation of the resource:
  - 5.4.1.1. What is the anticipated source and estimated daily usage of water at this facility? Are there any state usage fees or taxes associated with the water source?
  - 5.4.1.2. Has a water supply source been identified? If so, provide and describe the supply type.
  - 5.4.1.3. Are identified water source(s) capable of supplying the maximum design requirements of the facility?
  - 5.4.1.4. If applicable, what is the daily wastewater discharge rate (in mgd) anticipated to be?

5.5. Waste

- 5.5.1. Describe the type and disposal management method for wastes generated or anticipated to be generated at the location.

The statements contained in this RFP are made subject to the Reservation of Rights set forth in Appendix E of this RFP and the terms and acknowledgements set forth in the Proposal Submission Agreement

**APPENDIX C-1**  
Preliminary Due Diligence List (Developmental Resources)

- 5.6. Environmental Compliance (applicable to brownfield development sites or existing facilities except where noted)
  - 5.6.1. Where are copies of any facility or site environmental audit reports maintained, including results and corrective actions (including audits conducted internally and externally by federal or state agencies).
  - 5.6.2. Have there been any compliance actions as a result of prior environmental audit findings?
  - 5.6.3. Has the facility/site received any complaints from governmental or citizen groups concerning environmental matters (including, for purposes of this question, noise, fishkill, birdkill, and “Not in My Backyard” complaints) involving the project owner or any of its Affiliates? (Bidders of greenfield development proposals should respond as well.)
  - 5.6.4. Does the Bidder/project owner have (i) an environmental policy or statement of environmental commitment and (ii) an environmental management system? (Bidders of greenfield development proposals should respond as well.) If so, provide a copy of the policy(ies).
- 5.7. Operations (applicable to brownfield sites except where noted)
  - 5.7.1. Are there any proposed or pending environmental regulatory changes that would affect the expected plant operating status? Will facility equipment changes be required? If so, list and describe each pending change.
  - 5.7.2. Are there any environmental authorizations that (i) limit production or throughput or (ii) would render it necessary to increase significantly the volume of production or throughput at the facility? (Bidders of greenfield development proposals should respond as well.)
  - 5.7.3. Have there been any discontinued operations of the owner and any of its Affiliates at the location of the resource/site?
  - 5.7.4. Has an assessment been made to determine if any material capital expenditures or material expenses need to be incurred to comply with any existing environmental regulations? (Bidders of greenfield development proposals should respond as well.)
  - 5.7.5. Has an assessment been made to determine if any material capital expenditures or material expenses need to be incurred to comply with any environmental regulations that have been proposed (whether in preliminary or final form) but have not become effective? (Bidders of greenfield development proposals should respond as well.)
- 5.8. Environmental Attributes
  - 5.8.1. Describe the environmental attributes (and associated renewable portfolio standard or other renewable energy or environmental attribute required compliance program, any voluntary renewable energy or environmental attribute compliance program, and any other renewable energy or environmental attribute program or monitoring, tracking, certification, or trading system) for which the proposed resource is expected to be eligible, including eligibility for the Midwest Renewable Energy Tracking System (M-RETS) and Green-e programs.

The statements contained in this RFP are made subject to the Reservation of Rights set forth in Appendix E of this RFP and the terms and acknowledgements set forth in the Proposal Submission Agreement

**APPENDIX C-1**  
Preliminary Due Diligence List (Developmental Resources)

- 5.9. Community Outreach
  - 5.9.1. Provide Bidder's plan for community outreach.
  - 5.9.2. Provide documentation of any community support or opposition for the proposed project.
- 5.10. List any potential environmental impediments to project development, provide any associated documentation, and describe the plan to mitigate the impediment.

**6. Project Structure and Finance**

- 6.1. Provide an overview of the projected ownership structure for the project prior to and following commercial operation.
- 6.2. Provide a summary of the Bidder's/developer's plan for structuring and funding the project financing.
- 6.3. Provide Bidder's/seller's plan for meeting the credit/collateral requirements outlined in the RFP.
- 6.4. Provide evidence of at least one recent successful financing completed by Bidder (or an Affiliate) or that potential lenders have been engaged in initial, bona fide discussions to ascertain interest, market conditions, and indicative terms for financing the resource.
- 6.5. For project development-based proposals (and without limiting the requirements and terms of the RFP), Bidder should describe with specificity its proposed collateral or security postings throughout the development phase (including amounts or means of determining the amounts, type(s), and other relevant information), interim development milestones, consequences for failing to meet an interim milestone, target commercial operation date, guaranteed commercial operation date, delay damages, final deadline for achieving commercial operation (which, if not met, will trigger a Buyer termination right), and Buyer's step-in and lien rights.
- 6.6. Describe the form of collateralization that Bidder or Bidder's Credit Support Provider intends to offer for purposes of meeting the RFP's credit and collateral requirements.
- 6.7. List of any actual or expected resource-specific debt instruments; credit agreements, indentures, letters of credit, reimbursement agreements, guarantees, indemnity or assumption agreements and agreements relating to contingent obligations and any amendments thereto; any security or pledge agreements and any agreements or instruments evidencing a lien or encumbrance on or other right with respect to any of the assets of the resource.

The statements contained in this RFP are made subject to the Reservation of Rights set forth in Appendix E of this RFP and the terms and acknowledgements set forth in the Proposal Submission Agreement



**APPENDIX C-1**  
Preliminary Due Diligence List (Developmental Resources)

- 6.8. Provide pro-forma financial statements for the Bidder's project and audited financial statements for the Bidder and/or the Bidder's Credit Support Provider, including balance sheet, income statement, and statement of cash flows, along with the long-term debt structure and lien information that might impact the creditworthiness of Bidder and/or its Credit Support Provider.
- 6.9. The proposal must include the following information for Bidder and any entity that Bidder proposes as a Credit Support Provider in respect of any Definitive Agreement:
  - 6.9.1. Type of Business
    - Corporation
    - Limited Liability Company
    - Partnership
    - Other (describe)
  - 6.9.2. Organization
    - Legal Corporate Name
    - Street Address
    - City, State, Zip Code
    - Dun & Bradstreet Number
    - Federal Tax ID Number
    - Beneficial Ownership
    - List of Executives and Directors
  - 6.9.3. Credit Contact
    - Name
    - Title
    - Phone Number
    - Email Address
  - 6.9.4. For Corporations/Limited Liability Companies
    - Date and State of Incorporation/Registration
    - Street Address
    - City, State, Zip Code
  - 6.9.5. For General Partnerships
    - Name of General Partner
    - Address of General Partner/Registered Agent
    - City, State, Zip Code
  - 6.9.6. Most recent credit rating as determined by Moody's and/or S&P (if any).
  - 6.9.7. Most recent two (2) fiscal years and current fiscal year quarterly audited financial statements and accompanying notes. Indicate which statements below are being submitted.
    - 10-K
    - 8-K
    - 10-Q

The statements contained in this RFP are made subject to the Reservation of Rights set forth in Appendix E of this RFP and the terms and acknowledgements set forth in the Proposal Submission Agreement

**APPENDIX C-1**  
Preliminary Due Diligence List (Developmental Resources)

- Other (describe)

(Note that if financial information is consolidated with other entities, all data related to Bidder or Credit Support Provider should be extracted and submitted as separate documents by Bidder.)

- 6.10. List any pending claims, actions, disputes, or other proceedings currently pending or threatened against the project.
- 6.11. Provide copies of all relevant bankruptcy court orders, including the order discharging the project, debtor, and /or any Credit Support Provider from the bankruptcy proceedings.
- 6.12. Provide any tax abatement agreements with state or local authorities and any amendments thereto.
- 6.13. Provide documents related to any formal or informal property tax protests, litigation filed, related correspondence, legal opinions received, and judicial or administrative decisions rendered during the last ten years and year-to-date, and current status of any such proceedings.
- 6.14. Provide copies of any formal or informal property tax agreements (*i.e.*, PILOT, TIP, etc.) with state or local authorities in force during the preceding five years or effective in the current year or succeeding years.
- 6.15. List all applicable tax jurisdictions, tax rates, millage rates, assessment ratios, and the current equalization ratio.
- 6.16. If applicable, describe how the Federal production tax credit (PTC) established pursuant to Section 45 of the U.S. Internal Revenue Code would apply to the resource included in the proposal and for what duration.
- 6.17. If applicable, describe how the Federal investment tax credit (ITC) established pursuant to Section 48 of the U.S. Internal Revenue Code would apply to the resource.
- 6.18. Describe any other awards, grants, special tax treatment or credits, or subsidies that are or may be available to the resource. Describe the subsidies, identify any critical schedule deadlines, and indicate the anticipated likelihood of Bidder and/or the resource receiving such subsidies.
- 6.19. Explicitly identify the economic and other impacts to the resource in the event that any applicable award, grant, special tax treatment or credit, or subsidy is not received.
- 6.20. List the required real estate and related facilities, both owned and leased, with legal description, for development, ownership, use, and/or operation of the resource.

The statements contained in this RFP are made subject to the Reservation of Rights set forth in Appendix E of this RFP and the terms and acknowledgements set forth in the Proposal Submission Agreement

**APPENDIX C-1**  
Preliminary Due Diligence List (Developmental Resources)

- 6.21. List all easements, right-of-way, or other agreements for use of land or facilities entered into for purposes of securing the ability to construct the generating facility and associated infrastructure.

**7. NERC/CIP Compliance**

- 7.1. Identify the NERC Region within which the resource would be registered.
- 7.2. Provide a copy of NERC/CIP compliance program documents which would pertain to the resource.
- 7.3. Provide a copy of or explanation of any open mitigation plans and associated actions.
- 7.4. Provide a copy of the last audit report (public version).
- 7.5. If Bidder does not currently have active registrations or a current NERC/CIP compliance program, provide a summary of Bidder's compliance plan that will form the basis for a more detailed plan for compliance by the project and seller with any applicable NERC/CIP requirements for the proposed project once placed in service.

**8. Cost Recovery**

- 8.1. Specify with particularity the extent to which bidder proposes in a Special Consideration a different treatment or apportionment between Buyer and Seller of the Cost Recovery Risks described in Section 2.5 of the Main Body.

**9. Appendix D (Minimum Requirements) Information**

- 9.1. Provide all material and information that Bidder is required or requested to provide under Appendix D, to the extent not previously requested and provided in Appendix C-1.

The statements contained in this RFP are made subject to the Reservation of Rights set forth in Appendix E of this RFP and the terms and acknowledgements set forth in the Proposal Submission Agreement



## ***Appendix C-2***

***Preliminary Due Diligence List  
(Existing Resources)  
For  
2016 Request For Proposals  
For  
Long-Term Renewable  
Generation Resources  
For  
Entergy New Orleans, Inc.***

Entergy Services, Inc.  
July 13, 2016

The statements contained in this RFP are made subject to the Reservation of Rights set forth in Appendix E of this RFP and the terms and acknowledgements set forth in the Proposal Submission Agreement.

**APPENDIX C-2  
PRELIMINARY DUE DILIGENCE LIST (EXISTING RESOURCES)**

Bidders that intend to submit a proposal in the RFP based upon an Existing Resource must provide a comprehensive response to each question set forth in this Appendix C-2. Bidders should respond to any question that does not apply to the proposed existing resource with an “N/A” or “not applicable.” **Bidders must respond to each question by 5:00 pm CPT on the Proposal Submission Deadline.** Bidders are required to submit their response to the questions below in writing in such a way that clearly identifies the question to which each response pertains, and then provide the response via electronic mail or express delivery to the RFP Administrator.

Failure to submit a response to a question as required will increase the likelihood of a Bidder’s proposal being rejected as non-conforming and rejected from further consideration. Failure to provide a comprehensive response could negatively affect a proposal’s overall viability ranking. Bidders should keep in mind that this Appendix C-2 is not a prescriptive list of requirements for its resource, but instead is a list of items that RFP Evaluation Teams will use to assess the viability of individual resources. Any item requested in this Appendix C-2 that is not available, not presently known, or not otherwise provided by Bidder may count against its final viability score, but will not necessarily, in and of itself, cause its proposal to be declared non-conforming.

**1. Resource Overview and Market Experience**

- 1.1. Provide a thorough summary description of the resource, including, but not limited to, the location, site description, nameplate capacity, and the capacity of the resource, technology/generating equipment, and water source(s), if applicable. Anything provided in the summary should not otherwise limit Bidder’s response to any of the requirements below.
- 1.2. In detail, describe Bidder’s experience within MISO or other RTO markets.
- 1.3. Describe Bidder’s experience with the proposed technology.
- 1.4. Provide a list and summary of all power supply contracts (including ancillary services) to which Bidder is a party.
- 1.5. Provide a summary of the ownership or joint ownership of the resource.
- 1.6. Indicate whether the resource is or will be registered as a small power production facility with QF status.

**2. Environmental**

- 2.1. Does your resource have an environmental management system in place? If so, describe the system in detail.

The statements contained in this RFP are made subject to the Reservation of Rights set forth in Appendix E of this RFP and the terms and acknowledgements set forth in the Proposal Submission Agreement.

**APPENDIX C-2**  
**Preliminary Due Diligence List (Existing Resources)**

- 2.2. Provide a list and summary of any potentially contaminated activities at or nearby the resource/site that may have been identified or that Bidder may be aware of.
- 2.3. Provide a list and summary of all environmental permits/registrations associated with development, construction, ownership, use, operation of the resource or site, including any federal, state, or municipal permits issued related to the resource or site.
- 2.4. Describe any relevant pending permit/approval-renewal proceedings, any pending requests for permit/approval modification, and any expected hurdles to re-issuance.
- 2.5. Provide copies of any past or current environmental site assessments, including any draft and final reports of investigations or remediation studies of site or resource conditions, regarding past or current environmental conditions whether prepared on behalf of the owner or in the owner's possession or control.
- 2.6. Is the project site within a floodplain? If so, please identify the designated zone and the corresponding level of exposure.
- 2.7. Is there a storm water mitigation plan in place for the project site? Please include the details of the plan and mitigation controls.
- 2.8. Describe the resource's environmental performance over the past five years (*i.e.*, any violations, reportable events, or known investigations or environmental claims).
- 2.9. If applicable, provide a list of all groundwater monitoring or production wells at the site or resource and provide copies of state registrations for each well. Additionally, provide copies of geological and hydrogeological maps that provide details of the soil and groundwater underneath the resource.
- 2.10. Describe the environmental attributes (and associated renewable portfolio standard or other renewable energy or environmental attribute required compliance program, any voluntary renewable energy or environmental attribute compliance program, and any other renewable energy or environmental attribute program or monitoring, tracking, certification, or trading system) for which the proposed resource is eligible and currently registered and qualified, including eligibility for the Midwest Renewable Energy Tracking System (M-RETS) and Green-e programs.
- 2.11. Provide details on environmental attribute registration and tracking.

**3. Electric Interconnection**

The statements contained in this RFP are made subject to the Reservation of Rights set forth in Appendix E of this RFP and the terms and acknowledgements set forth in the Proposal Submission Agreement.

**APPENDIX C-2**  
**Preliminary Due Diligence List (Existing Resources)**

Interconnection

- 3.1. Provide a description of the interconnection facilities for the resource.
- 3.2. Provide the maximum generator/resource capability as studied in the generator interconnection agreement (PMAX Value).
- 3.3. List all applicable interconnection agreements.
  - 3.3.1. Provide the current status of the interconnection agreement(s), including the status of any pending interconnection requests (including, if applicable, for ERIS and NRIS) and any interconnection-related upgrades associated with those requests. For resources interconnected at distribution level within the ENOI Load Zone, provide details of existing interconnection, including interconnection voltage level and interconnection facilities.
  - 3.3.2. List any mandatory thermal, stability, and short-circuit upgrades, along with cost and time frames to implement the mitigation. (*Based upon facility study, if completed and available.*)

Network Service; Transmission

- 3.4. Provide any available information that may help ESI evaluate the ability of the Bidder to qualify the Facility (or portion thereof) as a Long-Term Network Resource in MISO.
- 3.5. Provide a description and details of any existing NRIS for the Facility.
- 3.6. Provide any available details about any past system impact studies, facility, or similar studies for NRIS for the Facility for deliverability or transmission service from the resource.
- 3.7. List any requests for any Regional Transmission Organization-sponsored deliverability study for the Facility and provide details of any such study.
- 3.8. If the resource is directly interconnected to the MISO System, provide details regarding any pending request for NRIS for the Facility, including a complete copy of the submitted interconnection application, a copy of either the MISO letter acknowledging the application or, if available, the actual study results related to such application and the associated MISO queue number as described in the first paragraph in Section 2.4.2 of the Main Body.
- 3.9. If the resource is directly interconnected to the MISO System, provide a description of any and all NRIS that will be needed for the resource as well as the timing requirements to secure that service.

The statements contained in this RFP are made subject to the Reservation of Rights set forth in Appendix E of this RFP and the terms and acknowledgements set forth in the Proposal Submission Agreement.

**APPENDIX C-2**  
**Preliminary Due Diligence List (Existing Resources)**

- 3.10. If the resource is not directly interconnected to the MISO System, provide the complete copy of the appropriate interconnection service application(s) and a copy of any acknowledgement letter (or similar document) from the applicable Balancing Authority or transmission authority as described in the second paragraph in Section 2.4.2 of the Main Body.
- 3.11. If the resource is not directly interconnected to the MISO System, provide a description of the plan to obtain the necessary firm point-to-point transmission service from the resource to the MISO South portion of the MISO System that will be needed for the resource as well as the timing requirements to secure that service and any applications submitted for such service.

**4. Financial Information**

- 4.1. Describe the current ownership structure of the resource.
- 4.2. Describe the form of collateralization that Bidder or Bidder's Credit Support Provider intends to offer for purposes of meeting the RFP's credit and collateral requirements.
- 4.3. List of resource-specific debt instruments; credit agreements, indentures, letters of credit, reimbursement agreements, guarantees, indemnity or assumption agreements, and agreements relating to contingent obligations and any amendments thereto; any security or pledge agreements; and any agreements or instruments evidencing a lien or encumbrance on or other right with respect to any of the assets of the resource.
- 4.4. Provide audited financial statements for the past three years for Bidder and/or Bidder's Credit Support Provider, including balance sheet, income statement, and statement of cash flows, along with the long-term debt structure.
- 4.5. The proposal must include the following information for Bidder and any entity that Bidder proposes as a Credit Support Provider in respect of any Definitive Agreement:
- 4.5.1. Type of Business
- Corporation
  - Limited Liability Company
  - Partnership
  - Other (describe)
- 4.5.2. Organization
- Legal Corporate Name
  - Street Address
  - City, State, Zip Code
  - Dun & Bradstreet Number
  - Federal Tax ID Number

The statements contained in this RFP are made subject to the Reservation of Rights set forth in Appendix E of this RFP and the terms and acknowledgements set forth in the Proposal Submission Agreement.



**APPENDIX C-2**  
**Preliminary Due Diligence List (Existing Resources)**

- Beneficial Ownership
  - List of Executives and Directors
- 4.5.3. Credit Contact
- Name
  - Title
  - Phone Number
  - Email Address
- 4.5.4. For Corporations/Limited Liability Companies
- Date and State of Incorporation/Registration
  - Street Address
  - City, State, Zip Code
- 4.5.5. For General Partnerships
- Name of General Partner
  - Address of General Partner/Registered Agent
  - City, State, Zip Code
- 4.5.6. Most recent credit rating (if any) as determined by Moody's and/or S&P
- 4.5.7. Most recent two (2) fiscal years and current fiscal year quarterly audited financial statements and accompanying notes. Indicate which statements below are being submitted.
- 10-K
  - 8-K
  - 10-Q
  - Other (describe)
- (Note that if financial information is consolidated with other entities, all data related to Bidder or Credit Support Provider should be extracted and submitted as separate documents by Bidder.)
- 4.6. Provide lien information that might impact the creditworthiness of Bidder and/or Bidder's Credit Support Provider.
- 4.7. List any material contracts/commitments not otherwise requested and any amendments thereto.
- 4.8. List any pending claims, actions, disputes, or other proceedings currently pending or threatened against the resource, Bidder, or Credit Support Provider.
- 4.9. List all relevant bankruptcy court orders, including the order discharging the project and debtor from the bankruptcy proceedings.
- 4.10. List all project contracts not rejected during the bankruptcy proceedings and still in effect, if any.

The statements contained in this RFP are made subject to the Reservation of Rights set forth in Appendix E of this RFP and the terms and acknowledgements set forth in the Proposal Submission Agreement.

**APPENDIX C-2**  
**Preliminary Due Diligence List (Existing Resources)**

- 4.11. List all contracts rejected by the debtor/project and terminated during the bankruptcy proceedings.
- 4.12. Advise as to whether any project funds are subject to a constructive trust or equitable lien in favor of third parties (per ruling of bankruptcy court).
- 4.13. If applicable, describe how the Federal production tax credit (PTC) established pursuant to Section 45 of the U.S. Internal Revenue Code would apply to the Facility or resource and for what duration.
- 4.14. If applicable, describe how the Federal investment tax credit (ITC) established pursuant to Section 48 of the U.S. Internal Revenue Code would apply to the resource with respect to Bidder's proposal, including whether Bidder has taken the ITC.
- 4.15. Describe any other awards, grants, special tax treatment or credits, or subsidies that are or may be available to the Facility. Describe the subsidies, identify any critical schedule deadlines, and indicate the anticipated likelihood of Bidder and/or the Facility receiving such subsidies.
- 4.16. Explicitly identify the economic and other impacts to the resource in the event that any applicable award, grant, special tax treatment or credit, or subsidy is not received.

**5. NERC/CIP Compliance**

- 5.1. Identify the NERC Region within which the resource is registered, the NERC registration number and when such registration occurred.
- 5.2. Provide a copy of current NERC/CIP compliance program documents pertaining to the resource.
- 5.3. Provide a copy of or explanation of any open mitigation plans and associated actions.
- 5.4. Provide a copy of the last audit report (public version).

**6. Plant and Equipment**

- 6.1. Provide a summary of property, plant, and equipment for the Facility.
- 6.2. Provide the site plan and general arrangement drawings for the Facility, including any relevant fuel and transportation infrastructure, inventory storage (if applicable) and one-line diagrams.

The statements contained in this RFP are made subject to the Reservation of Rights set forth in Appendix E of this RFP and the terms and acknowledgements set forth in the Proposal Submission Agreement.

**APPENDIX C-2**  
**Preliminary Due Diligence List (Existing Resources)**

- 6.3. Provide a station description and major equipment list (*e.g.*, turbines, P&ID, single line drawings).
- 6.4. Provide the plant design life.
- 6.5. Operational characteristics
  - 6.5.1. Provide P50, P75, P90, and P99 annual generation levels for each year of the remaining life of the facility and the methodology and supporting documentation for the determination of such generation levels.
  - 6.5.2. Provide historic hourly generation output data for the lesser of (i) each year the facility has been operating and (ii) the past five (5) years.
  - 6.5.3.
  - 6.5.4. Provide a description of the various modes of operation of the resource.
  - 6.5.5. Provide the minimum and maximum load range in each mode of operation.
  - 6.5.6. Provide the maximum ramp rates over the load range for each mode of operation.
  - 6.5.7. Provide the MVAR capability range of the resource; include “as tested results.”
  - 6.5.8. Is the resource equipped with automatic generation control (AGC)?
  - 6.5.9. If applicable, what is the operating range of the resource under AGC?
  - 6.5.10. What other electric products is the resource capable of providing?
  - 6.5.11. For wind resources, describe any sector management requirements.

**7. Operations and Maintenance**

- 7.1. Provide the budgeted and actual O&M expenses from 2013 to current, by significant category.
- 7.2. List the various entities that have been in charge of operation and maintenance of the resource, including any major subcontractors to date, and provide a timeline if there have been multiple entities.
- 7.3. Identify the expected operating party of the resource (self-operated, third-party contract, etc.).
- 7.4. Provide the qualifications of the expected operating party for the resource.
- 7.5. If expected to be operated under contract, provide a description of the expected contract, including term, scope, pricing structure, liability provisions, etc.
- 7.6. Describe any contract for maintenance of the resource or site not expected to be performed by the operating party.

The statements contained in this RFP are made subject to the Reservation of Rights set forth in Appendix E of this RFP and the terms and acknowledgements set forth in the Proposal Submission Agreement.

**APPENDIX C-2**  
**Preliminary Due Diligence List (Existing Resources)**

- 7.7. Provide the anticipated major maintenance schedule for the resource, by year, for the shorter of the life of the resource or anticipated PPA term.
- 7.8. Provide all electric generating statistics, including, but not limited to: (COD – present)
  - 7.8.1. Gross, auxiliary, and net generation and (if applicable) current UCAP (or unforced capacity) and ICAP (or installed capacity) recognized by MISO (or the RTO where the resource is located).
  - 7.8.2. EFOR.
  - 7.8.3. XEFOR.
  - 7.8.4. Historic outage rates (forced, maintenance, planned, etc.).
  - 7.8.5. Derate causes, time, and kWh.
  - 7.8.6. Curtailments and explanations.
- 7.9. Provide a list and results summary of any performance tests for the Facility.
- 7.10. List all inspection reports prepared for turbines, towers, and all electric systems.
- 7.11. Capital Projects – describe any major capital expenditures required over the term of the proposed PPA.
  - 7.11.1. Provide detailed information on all major capital expenditures (over \$1 million) with respect to the resource or site over the last three years.
  - 7.11.2. Describe capital work requests and any major maintenance expenditures planned.
  - 7.11.3. List all capital projects/commitments contracts, agreements, and orders.
- 7.12. Describe the balance of plant routine, predictive, and preventive maintenance activities.
- 7.13. Capacity-Related Benefits
  - 7.13.1. Identify any benefits associated with the capacity of the resource offered to Buyer, including any capacity credits or similar rights or benefits for which the resource qualifies, and the basis therefor.
  - 7.13.2. Describe any study or other action needed to qualify the resource for capacity-related benefits and provide the status and any results of each such study or action.
- 7.14. Other Commitments
  - 7.14.1. If applicable, provide a detailed description of any and all existing or future commitments of energy, capacity, capacity-related benefits, other electric products, and environmental attributes of the resource other than those contemplated by Bidder's proposal in the RFP.
  - 7.14.2. If applicable, confirm the offered capacity can be separately metered and operated as a separate resource into MISO markets.

The statements contained in this RFP are made subject to the Reservation of Rights set forth in Appendix E of this RFP and the terms and acknowledgements set forth in the Proposal Submission Agreement.

**APPENDIX C-2**  
**Preliminary Due Diligence List (Existing Resources)**

- 7.14.3. If applicable, describe how the output of the resource will be allocated between or among multiple offtakers (*e.g.*, dedicated units to each offtaker, pro rata, etc.) and how the market participant role is expected to be handled under such circumstances.

**8. Cost Recovery**

- 8.1. Specify with particularity the extent to which bidder proposes in a Special Consideration a different treatment or apportionment between Buyer and Seller of the Cost Recovery Risks described in Section 2.5 of the Main Body.

The statements contained in this RFP are made subject to the Reservation of Rights set forth in Appendix E of this RFP and the terms and acknowledgements set forth in the Proposal Submission Agreement.



## ***Appendix D***

***Minimum Requirements  
For  
Developmental Resources  
For  
2016 Request For Proposals  
For  
Long-Term Renewable  
Generation Resources  
For  
Entergy New Orleans, Inc.***

Entergy Services, Inc.  
July 13, 2016

**Appendix D**

**MINIMUM REQUIREMENTS FOR DEVELOPMENTAL RESOURCES**

This Minimum Requirements for Developmental Resources sets forth certain minimum requirements that Developmental Resources must satisfy in the 2016 Request for Proposals for Long-Term Renewable Resources for Entergy New Orleans, Inc. (“ENOI”) (the “RFP”) issued by Entergy Services, Inc. (“ESI”) on behalf of ENOI (the “**Minimum Requirements**”). The proposed Minimum Requirements are specified in the chart below, and are in addition to other RFP requirements that a Bidder in the RFP must satisfy. The Minimum Requirements are being created to ensure that a Developmental Resource offered in any proposal submitted in response to the RFP is developed to a degree meriting detailed, full-scale evaluation by the appropriate RFP Evaluation Teams and potential selection. Bidders are advised that the RFP will seek a substantial amount of information about any Developmental Resource proposed by a Bidder, not just the information necessary for a Bidder to meet the Minimum Requirements, and that satisfaction of the Minimum Requirements, standing alone, does not ensure a proposal’s eligibility for participation in the RFP; other RFP eligibility requirements specified in the RFP must also be met.

<b>Category</b>	<b>Minimum Requirement</b>	<b>Information Required to Evaluate Proposals against the Minimum Requirements</b>
Project Overview	Complete description of the Developmental Resource project.	Bidder must provide a reasonably thorough and accurate summary description of the project, including, but not limited to, the proposed location, site description, generation technology, major equipment, design basis, water source(s) (if applicable), plan for engineering, procurement, and construction, environmental compliance, and permitting, status of interconnection and non-standard project components/considerations, as well as a summary of the work completed on each of the Minimum Requirements. The provision of information in the summary description does not limit the requirement for Bidder to provide the information sought below.

The statements contained in this RFP are made subject to the Reservation of Rights set forth in Appendix E of this RFP and the terms and acknowledgements set forth in the Proposal Submission Agreement.

**Appendix D**  
**Minimum Requirements for Developmental Resources**

Category	Minimum Requirement	Information Required to Evaluate Proposals against the Minimum Requirements
Bidder Experience	Bidder (or the Person that will be the seller under Bidder’s proposal or a parent of either) must have completed at least one utility-scale project with the proposed technology and have project team members with a combined direct responsibility for at least three (3) completed utility-scale projects, regardless of technology.	Bidder must provide a summary that includes the key project team members, their relationship to Bidder ( <i>e.g.</i> , employee of Bidder or Bidder parent), their backgrounds, current title/position, and development experience, a description or list of relevant projects they and Bidder or Seller have completed, including project size and location.
Project Development	Bidder must provide evidence that project development for the proposed resource is beyond the conceptual phase for design, engineering, and plan for execution.	<ul style="list-style-type: none"> <li>○ <i>Engineering:</i> Bidder must provide evidence that the project has been translated from the screening and planning phase of development into a project definition of sufficient detail and quality to allow the efficient progression of detailed engineering and procurement if the Developmental Resource is selected.</li> <li>○ <i>Cost Estimate:</i> Bidder must provide evidence that its project cost estimate is based on front-end engineering from a qualified external and/or internal source that supports a Class 3 (as defined by AACE standards) cost estimate (-20% to +30%). (Bidders should not read the cost estimate allowance incorporated in this minimum requirement as indicating that Bidders may offer contingent pricing in their RFP proposals, except to the extent the contingency is solely the result of discrete, separately priced options offered to ENOI in Bidder’s proposal and that are permitted by the RFP.) At a minimum, the cost estimate should account for the following:           <ul style="list-style-type: none"> <li>i) generation equipment (<i>e.g.</i>, wind turbines, solar panels, hydro turbines, etc.) and technology;</li> <li>ii) mechanical and electrical equipment;</li> </ul> </li> </ul>

The statements contained in this RFP are made subject to the Reservation of Rights set forth in Appendix E of this RFP and the terms and acknowledgements set forth in the Proposal Submission Agreement.



**Appendix D**  
**Minimum Requirements for Developmental Resources**

Category	Minimum Requirement	Information Required to Evaluate Proposals against the Minimum Requirements
		<ul style="list-style-type: none"> <li>iii) instrumentation and controls;</li> <li>iv) piping;</li> <li>v) miscellaneous buildings;</li> <li>vi) utilities and major commodities (<i>e.g.</i>, steel, copper, etc.);</li> <li>vii) structural steel;</li> <li>viii) site work and foundations;</li> <li>ix) retrofit allowance (if applicable);</li> <li>x) sales and other applicable taxes;</li> <li>xi) engineering costs;</li> <li>xii) labor costs;</li> <li>xiii) interconnection costs;</li> <li>xiv) deliverability costs;</li> <li>xv) indirect costs;</li> <li>xvi) spare parts;</li> <li>xvii) escalation;</li> <li>xviii) licenses and permits;</li> <li>xix) construction financing costs;</li> <li>xx) taxes, including tax benefits (but excluding, for acquisition proposals, tax benefits unavailable to ENOI after the closing);</li> <li>xxi) project site and related real property costs;</li> <li>xxii) insurance; and</li> <li>xxiii) any other category not listed here and reasonably expected to be included for or applicable to the proposed technology.</li> </ul> <p>○ <i>Project Schedule:</i> Bidder must provide, at a minimum, a Level 2 (as defined by AACE standards) project schedule that supports all aspects of project execution, including development, design, engineering, financing,</p>

The statements contained in this RFP are made subject to the Reservation of Rights set forth in Appendix E of this RFP and the terms and acknowledgements set forth in the Proposal Submission Agreement.

**Appendix D**  
**Minimum Requirements for Developmental Resources**

Category	Minimum Requirement	Information Required to Evaluate Proposals against the Minimum Requirements
		<p>procurement, permitting, interconnection, construction, and testing, and project support materials that, along with the information provided in response to ESI’s due diligence questions in the RFP, demonstrate Bidder’s (or Seller’s) capability to meet the date by which commercial operation of the Developmental Resource is guaranteed by Bidder to have occurred and related project milestones for the proposed resource (financial closing, partial and full notices to proceed for major project contractors, completion of material environmental studies, applications for and receipt of major permits and environmental attribute accreditation, major equipment deliveries, foundation pours, completion of power and other material interconnections, etc.).</p>
Project Location	<p>ENOI prefers, but does not require, that resources other than Aggregated Solar PV Resources be located in or near the ENOI Load Zone. Aggregated Solar PV Resources must be located entirely within the ENOI Load Zone. Resources interconnecting at a distribution voltage level (less than 69 kV) must be located within specified portions of the ENOI Load Zone (as shown in the map in Section 2.4 of the Main Body).</p>	<p>Power from External Resources must be proposed to be physically delivered to a specified Physical Delivery Point on the MISO South portion of the MISO System. Bidders proposing resources other than an Aggregated Solar PV Resource must include a map and plat of the project location. Bidders proposing an Aggregated Solar PV Resource must provide the location of each host site or, if providing a site procurement plan pursuant to the “site control” Minimum Requirement, the information described in clauses (i) and (ii) below in such Minimum Requirement.</p>
Site Control	<p>For resources other than an Aggregated Solar PV Resource, Bidder must show that Seller (or an affiliate under Seller’s control) has control of the site on which the project would be located or has a</p>	<ul style="list-style-type: none"> <li>○ Bidder should provide a redacted copy of the definitive agreements or documents establishing the requisite control.</li> <li>○ Bidder must provide its own project site. ENOI will not offer to third-party bidders the use or control of any potential project site that ENOI owns or controls.</li> </ul>

The statements contained in this RFP are made subject to the Reservation of Rights set forth in Appendix E of this RFP and the terms and acknowledgements set forth in the Proposal Submission Agreement.

**Appendix D**  
**Minimum Requirements for Developmental Resources**

Category	Minimum Requirement	Information Required to Evaluate Proposals against the Minimum Requirements
	<p>valid, binding, and enforceable contract to obtain control of the project site for the full delivery term proposed by Bidder or the expected useful life of the resource. A letter of intent, memorandum of understanding, or other similar document contemplating the subsequent negotiation of a definitive agreement, in each case regarding Bidder's control of the project site, will not satisfy the foregoing site control requirement.</p> <p>If a Bidder of an Aggregated Solar PV Resource (or Seller or an affiliate under Seller's control) has not obtained site control over each of the sites upon which its individual Solar PV generating facilities will be located, such Bidder must have in place at the time of proposal submission (and provide to ESI upon request) a reasonable written site procurement plan to gain site control by a time that will support the project schedule (including the in-service date) for the proposed resource.</p>	<p>For an Aggregated Solar PV Resource, any site procurement plan relied upon by a Bidder that has not obtained the requisite site control as of proposal submission must identify and describe, in reasonable detail, (i) the sites that Bidder/Seller intends to utilize to locate such facilities, (ii) any back-up sites that Bidder/Seller intends to utilize if it is unable to obtain the requisite control of the sites identified in clause (i) above, (iii) the actions taken to date to obtain the requisite site control, (iv) the future actions Bidder/Seller intends to take to obtain the requisite site control, and (v) the timeline for establishing the requisite site control. In addition, the site procurement plan must assess in reasonable detail the risk that Bidder/Seller would be unable to obtain the requisite site control consistent with the schedule set forth in the timeline, including, without limitation, the material impediments to obtaining site control.</p>

The statements contained in this RFP are made subject to the Reservation of Rights set forth in Appendix E of this RFP and the terms and acknowledgements set forth in the Proposal Submission Agreement.

**Appendix D**  
**Minimum Requirements for Developmental Resources**

<b>Category</b>	<b>Minimum Requirement</b>	<b>Information Required to Evaluate Proposals against the Minimum Requirements</b>
Energy Source and Waste Disposal Plans	Bidder must have a viable plan for both the source of energy for and the disposal of waste from the project that is viable and, if implemented, would meet the requirements of the RFP applicable to Bidder’s proposal, and provide reasonable support for the viability of the plan.	<ul style="list-style-type: none"> <li>○ Bidder must provide expected hourly generation profiles and the methodology and supporting documentation for the determination of such generation. If available, Bidder should include supporting meteorological data from satellite, onsite, or nearby ground-mounted data measurement devices and/or a third-party resource assessment study. Preferably, the profiles should be based upon two (2) or more recent years of onsite meteorological data, to the extent available.</li> <li>○ Bidder must provide P50, P75, P90, and P99 annual generation levels and the methodology and supporting documentation for the determination of such generation levels.</li> <li>○ Include degradation rates over the term of the contract.</li> <li>○ For wind resources, Bidder must describe any expected sector management requirements.</li> <li>○ For resources that have a commercial waste component (including solid waste), Bidder must provide its waste disposal plan, which should include reasonable descriptions of the types of waste to be disposed of, the means and manner of disposal, and any material environmental issues associated with disposal known to or reasonably foreseeable by Bidder, and provide reasonable support for the viability of the plan.</li> </ul>
Environmental Assessment & Permitting	Bidder must provide a viable environmental compliance plan, including reasonable descriptions of Bidder’s plan to engineer, design, develop, procure, build, test, own/lease, operate, maintain, and repair the project (including the project site) in	<ul style="list-style-type: none"> <li>○ Bidder must provide a reasonable summary of the plan for complying with environmental laws and requirements applicable to the project.</li> <li>○ Bidder must show that all permitting due diligence necessary to prepare to apply for all required permits has been completed (<i>e.g.</i>, a copy of the draft permit application(s) <u>or</u> a summary of the permit application</li> </ul>

The statements contained in this RFP are made subject to the Reservation of Rights set forth in Appendix E of this RFP and the terms and acknowledgements set forth in the Proposal Submission Agreement.

**Appendix D**  
**Minimum Requirements for Developmental Resources**

Category	Minimum Requirement	Information Required to Evaluate Proposals against the Minimum Requirements
	<p>compliance with all applicable environmental laws, permits, authorizations, and other requirements, and provide reasonable support for the viability of the plan. Bidder must show that due diligence has been completed and action plans established to a level sufficient to support all permitting and material environmental attribute accreditation activities.</p>	<p>requirements, including descriptions of the plan to meet those requirements and obtain the permit(s)).</p> <ul style="list-style-type: none"> <li>○ Bidder must provide reasonably detailed plans to complete a Phase I environmental site assessment in accordance with ASTM E1527-13 and evidence and documentation of due diligence specific to the proposed site sufficient to support such an assessment (<i>e.g.</i>, documentation of work necessary to meet the primary components required under a Phase I according to ASTM E1527) or, if completed, an accurate summary of such assessment.</li> <li>○ Bidder must disclose any reasonably anticipated material permitting obstacle and any pending claim, action, or dispute related to its permitting activities related to the resource.</li> <li>○ Bidder must submit its reasonably detailed local community engagement and action plans related to permitting activities related to the resource.</li> <li>○ Bidder must have the necessary licenses and other authorizations under applicable laws and regulations to submit a proposal to ENOI in this RFP or offer to construct a Developmental Resource that would provide products to ENOI.</li> </ul>
<p>Electric Interconnection /Transmission/ Distribution</p>	<p>For a Developmental Resource to be interconnected at a transmission level directly to the MISO System, Bidder, Seller, or a third party acting on its or their behalf must complete and submit to MISO a complete interconnection application (“<u>IA</u>”) for the proposed resource in accordance with the MISO</p>	<p>Transmission Interconnection:</p> <ul style="list-style-type: none"> <li>○ Bidder must provide a copy of the IA application submitted to MISO and MISO queue number.</li> <li>○ Bidder’s IA must have sought a quantity of network resource interconnection service (“<u>NRIS</u>”) from MISO sufficient to allow the resource to be eligible to receive the maximum capacity credits a resource of its capacity size could receive under applicable MISO rules or</li> </ul>

The statements contained in this RFP are made subject to the Reservation of Rights set forth in Appendix E of this RFP and the terms and acknowledgements set forth in the Proposal Submission Agreement.

**Appendix D**  
**Minimum Requirements for Developmental Resources**

Category	Minimum Requirement	Information Required to Evaluate Proposals against the Minimum Requirements
	<p>generator interconnection process and the paragraph below. The resource must be able to be qualified as a long-term (or have a third party obtain such service or so qualify the resource) network resource and fully deliverable to MISO South.</p> <p>The application must request at least the amount of NRIS necessary for the resource to have the Minimum Required NRIS Quantity. The completed application must identify the location of the proposed resource, the Balancing Authority substation to which the proposed resource would be interconnected, and the Electric Interconnection Point.</p> <p>For External Resources, Bidder, Seller or a third party acting on its or their behalf will be required to obtain both interconnection service and firm deliverability/transmission service to enable Seller to deliver at least the maximum amount of energy that Seller</p>	<p>allocation and prioritization of NRIS for the resource such that the NRIS level associated with the resource capacity that would be under contract to ENOI could not limit the amount of MISO capacity credits that ENOI would receive for any planning period during the delivery term to be proposed (“<u>Minimum Required NRIS Quantity</u>”).</p> <p>External Resources:</p> <p>For External Resources, Bidder must have initiated the process(es) for receipt of the interconnection, deliverability, and transmission service required under the terms of the RFP for the proposed resource, completed and submitted to the applicable Balancing Authority/transmission owner the appropriate application(s), including the required supporting information, to receive such service, and provided as part of its Proposal Package a complete and accurate copy of each such application.</p> <p>Distribution Interconnection:</p> <ul style="list-style-type: none"> <li>○ Bidders selected for negotiation of a Definitive Agreement or so directed by ESI will be required to prepare, complete, and submit to ENOI, in accordance with the applicable application requirements (and, if applicable, ESI’s directions), an interconnection service application for the proposed distribution-level resource. Bidder must provide to the RFP Administrator complete and accurate copies of any interconnection application submitted to ENOI pursuant to ESI’s direction and other documents related to such application required by ESI.</li> <li>○ Bidder must interconnect the resource to a portion of the distribution system owned by ENOI, and the proposed resource must be compliant with applicable laws, rules, codes, contractual requirements (including,</li> </ul>

The statements contained in this RFP are made subject to the Reservation of Rights set forth in Appendix E of this RFP and the terms and acknowledgements set forth in the Proposal Submission Agreement.

**Appendix D**  
**Minimum Requirements for Developmental Resources**

<b>Category</b>	<b>Minimum Requirement</b>	<b>Information Required to Evaluate Proposals against the Minimum Requirements</b>
	<p>may deliver to the Physical Delivery Point under a Definitive Agreement.</p> <p>Bidders proposing to interconnect a resource to the ENOI distribution grid may, but are not required to (unless otherwise directed by ESI), complete, execute, and submit (or have Seller or a third party complete, execute, and submit) the Appendix H, Exhibit H-3, Distribution Inter-Connection Process application. The resource must be able to be qualified as a load modifying resource in MISO and may not require more than 10 MW of distribution interconnection service.</p> <p>A proposed resource may not interconnect to the ENOI distribution grid “behind the meter” or be offered to ENOI under or as part of a “net metering” billing arrangement.</p>	<p>without limitation, those in applicable interconnection contract(s)), and health and safety standards, such as, for example only, IEEE 1547.</p> <ul style="list-style-type: none"> <li>○ Resources proposed to be interconnected at a distribution level should be designed to deliver three-phase alternating current at the required voltage to the distribution grid. Bidders must furnish revenue quality metering equipment and systems (including RTU equipment) with power quality (harmonics, flicker, etc.) monitoring features, all meeting applicable ENOI requirements, and step-up transformers as provided in the Main Body.</li> </ul> <p>Bidders should note that electrical interconnection and deliverability costs and risks associated with a resource may be an important part of the evaluation of proposals in the RFP. Bidders should be prepared to develop and provide detailed information about the electrical interconnection and deliverability costs and risks associated with their resources/proposals. Some of this information could require significant time and the expertise of one or more third parties to develop and prepare. Bidders will bear exclusive responsibility for obtaining and paying for electrical interconnection and transmission/distribution service for their proposed resource, including, without limitation, the costs of interconnection upgrades and upgrades necessary for the required amounts of NRIS and other interconnection service for the resource, and for developing their proposals to include and account for, without limitation, all such upgrades.</p>
Water Source	Bidder must have a viable plan for access to adequate and sustainable supplies of water capable of meeting the maximum design requirements of the proposed resource, the treatment of	For renewable resources that require water for the generation of power or have a significant need for reliable water supply for normal operation and/or maintenance of the resource, Bidder must provide a viable water supply plan, including reasonable descriptions of the proposed primary source and quality

The statements contained in this RFP are made subject to the Reservation of Rights set forth in Appendix E of this RFP and the terms and acknowledgements set forth in the Proposal Submission Agreement.

**Appendix D**  
**Minimum Requirements for Developmental Resources**

Category	Minimum Requirement	Information Required to Evaluate Proposals against the Minimum Requirements
	water for the resource, and provide reasonable support for the viability of the plan.	of the project’s raw water supply and any physical and contractual requirements necessary to secure and utilize the water supply.
Project Structure & Finance	Bidder must have a viable plan for project structure and financing that is supported by recent experience and/or market intelligence.	<ul style="list-style-type: none"> <li>○ Bidder must describe the plan to finance the project, including a detailed description of any application for publicly subsidized loans, debt guarantees, tax relief or incentives, bonds, or other public funding.</li> <li>○ Bidder must describe the projected ownership structure of the Developmental Resource prior to the delivery term commencement date and after the delivery term commencement date (for PPA proposals) or prior to the closing (for acquisition proposals).</li> <li>○ Bidder must be able to provide evidence of at least one recent successful project financing completed by Bidder, Seller, or the parent of Seller or that potential lenders have been engaged in initial, bona fide commercial discussions to ascertain interest, market conditions, and indicative terms.</li> <li>○ Bidder must describe how it intends to meet the applicable credit/collateral requirements specified in the RFP.</li> </ul>

Bidders that fail to meet one or more of the Minimum Requirements may be required, at ESI’s election, to provide, or to have Seller provide, supplemental security (i) as a condition to continued participation in the RFP and, if applicable, (ii) to support any letter of intent entered into by Bidder or Seller (or a party acting on its behalf) in connection with the RFP (see Section 6.2 of the Main Body and Appendix F). The security would be separate from, and in the case of clause (ii) above, incremental to, any letter of credit required to be posted in connection with clause (ii). The purpose of the enhanced collateral support would be to hedge the risk that Bidder (or Seller) will withdraw the proposal, substantially change the material terms of the proposal, or be unable or choose not to honor the terms of the proposal prior to completing the negotiation of a Definitive Agreement between Seller and ENOI. The amount of the supplemental security would be determined by ESI on a case-by-case basis and would be dependent upon its assessment of the Minimum Requirements not satisfied by Bidder. ESI’s assessment would take into consideration evidence provided by Bidder that it has been using, continues to use, and will

The statements contained in this RFP are made subject to the Reservation of Rights set forth in Appendix E of this RFP and the terms and acknowledgements set forth in the Proposal Submission Agreement.



**Appendix D**  
**Minimum Requirements for Developmental Resources**

continue to use good faith efforts to meet the Minimum Requirements that Bidder has failed to satisfy. The amount of supplemental security a Bidder may be required to post would not exceed \$1 million.

If called upon to post supplemental security, Bidder will have the option either to post (or have Seller post) the required amount of supplemental security or to withdraw the proposal(s) that failed to meet the Minimum Requirements from the RFP. The proposal(s) of any Bidder that posts the required amount of supplemental security according to the terms of the RFP will be allowed to remain in the RFP, subject to the other terms of the RFP.

Supplemental security posted as a condition to continued participation in the RFP may be replaced with other security upon execution of a Definitive Agreement between Seller and ENOI. If Bidder is required to post supplemental security pursuant to clause (i) above and its proposal (a) is not selected for negotiation or potential negotiation of a Definitive Agreement with ENOI or (b) is selected but is subsequently released from its proposal(s) as allowed for in the RFP, the supplemental security will be returned to Bidder, subject to and in accordance with the terms of the RFP and the letter of credit. ENOI will have no obligation to return and may retain any and all funds drawn under the letter of credit in accordance with the terms thereof.

The statements contained in this RFP are made subject to the Reservation of Rights set forth in Appendix E of this RFP and the terms and acknowledgements set forth in the Proposal Submission Agreement.

2016 ENOI RENEWABLES RFP



***Appendix E***

***Reservation of ESI Rights  
and Other RFP Terms***

***For***

***2016 Request For Proposals***

***For***

***Long-Term Renewable  
Generation Resources***

***For***

***Entergy New Orleans, Inc.***

Entergy Services, Inc.  
July 13, 2016

## APPENDIX E RESERVATION OF ESI RIGHTS AND OTHER RFP TERMS

### 1. Reservation of Rights

Notwithstanding anything to the contrary, each of ESI and ENOI may, and expressly reserves the right to, at any time, and from time to time, without prior notice, and without assigning or providing any reason therefor:

- cancel, suspend, withdraw, or terminate this RFP (including, without limitation, after the selection under this RFP of one or more Bidders for a Definitive Agreement) or cancel or suspend its participation in this RFP;
- modify this RFP, including, without limitation, any Appendix to this RFP or any of the dates, times, or places set forth in this RFP or related to the RFP process<sup>1</sup> ;
- accept, refuse to accept, consider, not consider, favor, disfavor, recommend, not recommend, pursue, or reject any proposal, in its sole and absolute discretion, for any reason;
- without limitation of the generality of any of the other terms herein, reject or eliminate any proposal that is incomplete, is non-conforming, or contains irregularities (or waive or disregard any deficiency, non-conformity, or irregularity in any proposal), or that it determines was made with the intent to create artificial prices, terms, or conditions or would have that effect;
- carry out negotiations with any, some, or all Bidders or other Persons (other than (i) any Entergy Regulated Affiliate except ENOI or (ii) any Entergy Competitive Affiliate) related to this RFP, and suspend or terminate negotiations with any Bidder or other Person at any time, including, without limitation, as a result of (a) any change in any of the resource needs of ENOI, (b) any adverse diligence finding by ESI or ENOI, or (c) any other issue related to the potential Transaction arising during negotiations of any LOI, Definitive Agreement, or other agreement, including, without limitation, any issue arising out of any special consideration submitted by Bidder in its proposal or any new or modified rule, regulation or other law;
- discuss the terms of any proposal or any other material submitted by Bidder with, and obtain clarification or additional information concerning such proposal or such other material from, Bidder or its directors, officers, employees, agents, representatives, and advisors;
- request from Bidder any information not detailed in or required by this RFP but that, in ESI's sole opinion, may be necessary or relevant to the evaluation of Bidder's proposal(s) and utilize such information as ESI deems appropriate in connection with such evaluation of this RFP;

#### 1.1.1. \_\_\_\_\_

<sup>1</sup> Modifications to this RFP will be posted on ESI's website for this RFP; although ESI will attempt to notify prospective Bidders of any material modifications to this RFP, Bidders should monitor the website on a regular basis for updates that could affect Bidder.

The statements contained in this Appendix E are subject to the terms and acknowledgements set forth in the Proposal Submission Agreement.

- receive, consider, pursue, and/or transact on (i) opportunities to acquire or contract for other assets or resources offered or that become available outside of the RFP process as such opportunities arise or (ii) proposals offered in response to this RFP that are non-conforming or have been eliminated from consideration in this RFP;
- invite further proposals in or outside of this RFP or supplemental submissions or modifications of previously submitted proposals in this RFP;
- determine which Bidders or entities to allow, or continue to allow, to participate in the RFP process;
- pursue or transact on proposals offered in response to this RFP regardless of any rank order of proposals established in the RFP evaluation process, in order to limit exposure to a particular counterparty, technology type or vintage, manufacturer, or resource or a particular set of risks, diversify its power supply portfolio, gain experience with one or more generation technologies or resources, or achieve one or more other commercial goals as ESI or ENOI deems appropriate;
- sign or not sign Definitive Agreement(s) with Bidders or other Persons relating to the Products solicited by this RFP;
- in consultation with the IM, accept or reject any recommendation of any consulting engineer engaged by ESI in connection with the Self-Build Option (if any) or any proposal submitted in this RFP;
- subject to the terms of any applicable confidentiality agreement entered into between ESI and Bidder, retain, archive, or destroy any information or material provided to or for the benefit of ESI in the Proposal Submission Process;
- taking actions it deems appropriate after selections have been made, including, without limitation, conducting analyses of proposals, updating evaluations of proposals, correcting errors in prior analyses of proposals, accounting for contingencies, and re-ranking proposals; and
- take any and all other actions it deems necessary or appropriate, in its sole and absolute discretion, in connection with this RFP and the RFP process.

Each of the foregoing rights (including any right listed in a series of rights) may be exercised individually by ESI, the Entergy Operating Committee (until the termination or cancellation of the Entergy System Agreement), the operating committee for ENOI, or any director, officer, employee, or authorized agent or representative of ESI, ENOI, or any of their respective parents. The reservation of rights contained herein is in addition to all other rights reserved or granted to ESI or any of its Affiliates elsewhere in this RFP or otherwise held by or available to ESI or any of its Affiliates.

## **2. No Warranties or Liabilities**

**BY PARTICIPATING IN THE RFP PROCESS, EACH BIDDER AGREES THAT, EXCEPT TO THE EXTENT OTHERWISE EXPRESSLY SET FORTH IN A DEFINITIVE AGREEMENT WITH BIDDER:**

The statements contained in this Appendix E are subject to the terms and acknowledgements set forth in the Proposal Submission Agreement.

- (A) ALL MATERIAL AND OTHER INFORMATION FURNISHED BY OR ON BEHALF OF ESI, ENOI, OR ANY OTHER AFFILIATE OF ESI IN CONNECTION WITH THIS RFP IS PROVIDED WITHOUT ANY REPRESENTATION OR WARRANTY OF ANY KIND, INCLUDING, WITHOUT LIMITATION, ANY REPRESENTATION OR WARRANTY AS TO THE ACCURACY OR COMPLETENESS OF SUCH INFORMATION, AND
- (B) ESI, ITS AFFILIATES, AND THEIR RESPECTIVE DIRECTORS, OFFICERS, MEMBERS, PARTNERS, EMPLOYEES, AGENTS, REPRESENTATIVES, AND ADVISORS, AS WELL AS THE IM, SHALL HAVE NO LIABILITY TO ANY BIDDER, ANY OF ITS AFFILIATES, OR ANY OF THEIR RESPECTIVE DIRECTORS, OFFICERS, MEMBERS, PARTNERS, EMPLOYEES, AGENTS, REPRESENTATIVES, ADVISORS, LENDERS, OR INVESTORS RELATING TO OR ARISING FROM THE USE OF OR RELIANCE UPON ANY SUCH INFORMATION, ANY ERROR OR OMISSION THEREIN, OR OTHERWISE IN CONNECTION WITH THIS RFP.

### **3. Acceptance of Proposals**

Without prejudice to ESI's rights under the Proposal Submission Agreement or at law or in equity, no proposal submitted by any Bidder shall be deemed accepted by, or otherwise binding upon, ESI or any of its Affiliates (including ENOI) and ESI, its Affiliates (including ENOI) and their respective directors, officers, members, employees, agents, and representatives shall have no obligation or liability of any kind with respect to any such proposal or otherwise in connection with this RFP, unless and until a Definitive Agreement has been mutually executed and delivered by ESI or any of its Affiliates and Seller, and then such obligation or liability shall exist only if and to the extent expressly set forth or provided for therein or in another signed, binding written agreement entered into by ESI or any of its Affiliates and Seller. Notwithstanding anything to the contrary in this RFP, all proposals delivered to ESI shall become the sole and exclusive property of ESI upon receipt, and ESI shall have all rights and privileges of ownership of such property, subject to any provision of this RFP relating to confidentiality and any applicable confidentiality or other signed, binding written agreement between ESI and Bidder or Seller executed in connection with this RFP process.

### **4. Bidder Costs and Expenses**

Each Bidder is solely responsible for all costs and expenses it incurs in connection with this RFP. Through its participation in this RFP, each Bidder agrees that under no circumstance, including, without limitation, ESI's withdrawal from or suspension, cancellation, or termination of the RFP process, will ESI, any of its Affiliates, or any of their respective directors, officers, members, partners, employees, agents, representatives, or advisors have any responsibility or liability of any kind to Bidder, its Affiliates, or any of their respective directors, officers, members, partners, trustees, employees, agents, representatives, advisors, or lenders for any cost

The statements contained in this Appendix E are subject to the terms and acknowledgements set forth in the Proposal Submission Agreement.

or expense directly or indirectly incurred by Bidder (no matter how incurred) in connection with the RFP process, except to the limited extent provided in Section 5.2 of the Main Body (relating to Bidder Registration Fee refunds). Nothing in this Section 4 shall be construed to limit the generality of Section 2 above.

## **5. Bidder Disclosure of RFP Information**

No Bidder may, without the prior consent of ESI, disclose to any other Person (except those participating in the same proposal, to the extent permitted in Section 7.7 of the Main Body, the RFP Administrator, and the Independent Monitor) its participation in the RFP process, other than by attendance at any meeting to which more than one participant is invited by ESI, which attendance in and of itself will not violate this provision of this RFP. Further, no Bidder may disclose, collaborate on, or discuss with any other Person (except those participating in the same proposal, to the extent permitted in Section 7.7 of the Main Body, the RFP Administrator, and the Independent Monitor) bidding strategies or the substance of proposals, including, without limitation, the price or any other terms or conditions of any contemplated, indicative, or final proposal. Any such disclosure, collaboration, or discussion would violate this RFP and the Proposal Submission Agreement and may result in the rejection of Bidder's proposal or elimination of Bidder from further participation in this RFP.

## **6. Consents and Regulatory Approvals**

Bidder/Seller will be responsible for obtaining and maintaining all consents, authorizations, and regulatory approvals necessary for the performance of its obligations under the Definitive Agreement. Please consult Appendices B-1 and B-2 of this RFP for additional information regarding regulatory approvals and conditions precedent to the Delivery Term.

ENOI will be responsible for obtaining all applicable regulatory approvals it requires for any Transaction arising out of this RFP, including, without limitation, authorization from any Governmental Authority with jurisdiction over ENOI. The commencement of the Delivery Term under any PPA arising out of this RFP will be conditioned upon the receipt of regulatory approvals on terms acceptable to ESI or ENOI in its sole and absolute discretion.

## **7. Bidder Acceptance of Appendix E**

By participating in the RFP process, each Bidder agrees that it will be deemed to have accepted all of the rights and terms included in this Appendix E and to have agreed that its participation in this RFP is subject to such rights and terms. ESI and ENOI are conducting this RFP and participating in the RFP process in reliance upon the foregoing agreement.

The statements contained in this Appendix E are subject to the terms and acknowledgements set forth in the Proposal Submission Agreement.



***Appendix F***

***Credit/Collateral Requirements***

***For***

***2016 Request For Proposals***

***For***

***Long-Term Renewable***

***Generation Resources***

***For***

***Entergy New Orleans, Inc.***

Entergy Services, Inc.  
July 13, 2016

**Appendix F**  
**Credit/Collateral Requirements**

**APPENDIX F**

**CREDIT/COLLATERAL REQUIREMENTS**

This Appendix F contains a brief overview of the credit evaluation procedures expected to be utilized during the overall proposal evaluation process for the RFP. These procedures seek to assure that Seller’s credit quality, when considered in the context of Bidder’s proposal to ESI, complies with Entergy’s corporate risk management standards, and that any requirement for credit support associated with the proposal is identified.

**A. Requirements for Proposal Submission**

For purposes of ESI’s credit evaluation procedures, a conforming proposal must include the information requested in either Section 6 of Appendix C-1 or Section 4 of Appendix C-2, as applicable, to the RFP for Seller and any Credit Support Provider, including, if financial information is consolidated with other entities, all data related to Seller or Credit Support Provider that must be extracted and submitted as separate documents by Bidder according to Section 2.3.4 of the Main Body. If the information Bidder provides in support of a proposal falls below the Credit Assessment Threshold Requirements for credit (as specified in Section 2.3.4 of the Main Body), Bidder must, upon ESI’s request, provide reasonable evidence of Seller’s ability to provide the credit support required to meet this RFP’s credit support requirements.

**B. Determination of Credit Support Requirements**

The Credit Evaluation Team (“CET”) will apply its own internal procedures to determine, for each Bidder who submits a proposal, the “**CET Credit Rating**” of Seller. These procedures include, without limitation, a credit analysis of financial statements utilizing, among other things, leverage, liquidity, and profitability metrics. If Seller has a Published Credit Rating, the CET Credit Rating will, in most cases, be equivalent to such Published Credit Rating.

Based on Seller’s CET Credit Rating, the CET will determine how much credit support Seller will be required to provide initially under the Definitive Agreement, if entered into by Seller and ENOI. For rough guidance, a Seller will initially be required to provide credit support in the amount set forth in the table below for each MW of nameplate capacity allocated to Buyer under the applicable Definitive Agreement, depending on the length of the Delivery Term:

<u>Length of Delivery Term</u>	<u>\$ per MW of Nameplate Capacity Allocated to Buyer</u>
10-20 years	\$100,000-\$250,000/MW

Sellers with a CET Credit Rating equivalent to BB+ or below from S&P or Ba1 or below from Moody’s will not have any offsets to these required amounts of credit support, while Sellers with higher CET Credit Ratings will get credit towards these amounts that may reduce or eliminate the requirement for such Sellers to initially provide credit support under the Definitive Agreement.

Required credit support could take the form of:



**Appendix F**  
**Credit/Collateral Requirements**

- a parent guaranty
- a letter of credit from a bank acceptable to ESI
- cash collateral
- a lien on the power generation project and/or other assets
- other forms of credit support suggested by Bidder
- combinations of the foregoing.

The form and substance of any credit support initially provided by or on behalf of Seller must be acceptable to ESI in its sole discretion.

For Credit Support Providers, the CET will undertake a similar process. Seller will get credit toward its credit support requirements for the credit support provided by such Credit Support Provider if and only if the CET Credit Rating for such Credit Support Provider meets the requirements for such type of credit support. For rough guidance, a Credit Support Provider that is the direct or indirect parent of Bidder and has a CET Credit Rating equivalent to BBB- or higher from S&P and Baa3 or higher from Moody's will be eligible to provide a parent guaranty. The CET Credit Rating requirements are higher for a bank providing a letter of credit or holding cash collateral. In either case, the amount of credit Seller will receive toward its credit support requirements for the credit support provided by such Credit Support Provider will vary depending on the CET Credit Rating of such Credit Support Provider.

If a Seller's or Seller's Credit Support Provider's CET Credit Rating is sufficiently reduced at any time or Buyer has reasonable grounds for insecurity regarding the payment or performance of an obligation under the Definitive Agreement during the term of the Definitive Agreement, Buyer will have the right to require that additional credit support (or, if such Seller did not initially provide credit support, an initial amount of credit support) be provided by such Seller at that time. Conversely, credit support may be returned to Seller if its CET Credit Rating improves sufficiently during the term of the Definitive Agreement.

With respect to any credit support that does not involve a Credit Support Provider (such as a lien on assets), the CET will apply its own internal procedures to determine the credit Bidder will get toward its credit support requirements for such credit support. The amount of such credit will be discussed with Bidder as part of the credit support discussion for each proposal (if any) from such Bidder is selected for the applicable Primary Selection List or the applicable Secondary Selection List.

**C. Minimum Requirements-Based Credit Support**

The VAT will notify the CET whether one or more Bidders have submitted proposals in which the Developmental Resource or the proposal fails to meet one or more of the Minimum Requirements set forth in Appendix D. After receipt of such notice, the CET may require Bidder to post a letter of credit, generally in the form described herein [the draw conditions will be modified as provided in Exhibit 2 to Annex F-1 below], of up to \$1 million, within 30 days after Bidder's receipt of notice of such requirement. The amount of the letter of credit will be determined by the CET, with input from the VAT, and in consultation with the IM. The letter of credit must be issued by a U.S. commercial bank or the U.S. branch office of a foreign bank that (in either case) has a Published Credit Rating of at least A- from S&P and A3 from Moody's and

**Appendix F**  
**Credit/Collateral Requirements**

total assets of at least \$10 billion. If Bidder's proposal(s) supported by the letter of credit are eliminated from consideration in this RFP or otherwise do not result in an LOI, the letter of credit will be returned to the posting party within thirty (30) days after such date, provided that if ESI, as agent for ENOI, has determined, in its good faith judgment, that ESI, as agent, has or may have a right to draw under the terms of the letter of credit, ESI will notify Bidder thereof in writing within thirty (30) days after such date and, subject to the following sentence, will not be required to cause the letter of credit to be returned to the posting party until ESI, as agent, has determined not to draw under the letter of credit. If ESI has provided such notice, but has neither drawn an amount under the letter of credit on or before five (5) months of such notice nor notified Bidder that it has elected to draw under the letter of credit, then ESI will cause the letter of credit to be returned to the posting party no later than ten (10) days after the expiration of such five (5)-month period.

**D. Bidder Selection**

A Bidder whose proposal is selected to the applicable Primary Selection List or the applicable Secondary Selection List is expected to be invited to discuss with the CET the CET Credit Rating of Seller proposed for such Bidder and asked to indicate the type of credit support Seller desires to provide in order to meet the RFP's credit support requirements. During such discussions, ESI will also discuss with Bidder the CET Credit Rating for any Credit Support Provider and the value determined by the CET with respect to any proposed credit support that does not involve a Credit Support Provider. While credit support will not, except as provided in Section C above and Section E below, need to be posted until the execution of the Definitive Agreement, Bidder's proposal may be eliminated from further consideration if, at the time of such discussions, Bidder either fails to describe adequately its strategy for providing (or does not have an adequate strategy), or demonstrates an unwillingness or inability to provide, the required credit support. Further, while ESI reserves the right to move forward with any Bidder unwilling to offer satisfactory credit support, ESI will be reluctant to select any proposal from any such Bidder unless the proposal, even without satisfactory credit support, is clearly superior to proposals for similar product offerings. Finally, please note that, in the selection of Bidders for the Primary Selection List and the Secondary Selection List, the CET may establish limits for the aggregate amount of ENOI's exposure under or pursuant to the RFP and existing transactions of ENOI to a Seller or to certain groups of suppliers, including groups that are supported by the same Credit Support Provider and groups with weak CET Credit Ratings. These limits may be taken into account in the CET's evaluation of proposals.

**E. LOI Execution and Contract Negotiation**

Any Bidder notified that its proposal has been selected for final negotiation (and, if different from Bidder, the proposed Seller) may be required by Buyer to enter into an LOI setting forth and/or addressing key terms and conditions of the proposed Transaction. Upon execution of the LOI, Bidder or Seller (as applicable) will be required to provide to ESI or its designee (i) a letter of credit in the amount of \$100,000/MW for each MW of Capacity to be purchased under the proposed Transaction plus (ii) if, at the time of execution of the LOI, Bidder fails or continues to fail to meet one or more of the Minimum Requirements found in Appendix D, an additional amount, to be determined by the CET, with input from the VAT, of up to \$1 million. The incremental amount in clause (ii) above will not duplicate amounts posted pursuant to

**Appendix F**  
**Credit/Collateral Requirements**

Section C above and will be a function of the number, severity, and other aspects of the failures to meet the Minimum Requirements. The letter of credit must be issued by a U.S. commercial bank or the U.S. branch office of a foreign bank that (in either case) has a Published Credit Rating of at least A- from S&P and A3 from Moody's and total assets of at least \$10 billion. Such letter of credit will be in a form substantially similar to the form letter of credit attached as Annex F-1. If Bidder puts in place a letter of credit pursuant to Section C and enters into an LOI with Buyer, it is expected that the existing letter of credit would be modified to reflect the new principal amount due under this Section E and the new draw conditions that would apply. If the existing letter of credit is not modified, however, and a new and separate letter of credit is posted in support of the LOI, the incremental amount in clause (ii) above will not duplicate the amounts that are subject to the existing letter of credit.

**Annex F-1**  
**Form of Letter of Credit**

Irrevocable Standby Letter of Credit No. [L/C NUMBER]

Date: [L/C ISSUANCE DATE]

BENEFICIARY:  
ENTERGY SERVICES, INC.  
FOR THE BENEFIT OF ENTERGY NEW ORLEANS, INC. AND ITS SUCCESSORS AND  
PERMITTED ASSIGNS  
10055 GROGANS MILL RD, SUITE 300  
THE WOODLANDS, TEXAS 77380

APPLICANT:  
[INSERT NAME]  
[ON BEHALF OF [\_\_\_\_\_]]  
[INSERT ADDRESS]  
[INSERT CITY/STATE/ZIP CODE]

LADIES AND GENTLEMEN:

AT THE REQUEST AND FOR THE ACCOUNT OF [INSERT NAME OF APPLICANT] (THE "APPLICANT"), [INSERT ADDRESS OF APPLICANT], [AND ON BEHALF OF [INSERT NAME OF ACCOUNT PARTY] (THE "ACCOUNT PARTY")], WE, [INSERT NAME OF BANK] (THE "ISSUER"), HEREBY ESTABLISH, EFFECTIVE IMMEDIATELY, IN FAVOR OF ENTERGY SERVICES, INC. (THE "BENEFICIARY"), OUR IRREVOCABLE STANDBY LETTER OF CREDIT NO. [L/C NUMBER] IN THE AGGREGATE AMOUNT OF [INSERT AMOUNT REQUIRED PURSUANT TO THE AGREEMENT (DEFINED BELOW)] UNITED STATES DOLLARS (U.S. \$\_\_\_\_\_) (AS SUCH AMOUNT MAY BE REDUCED FROM TIME TO TIME BY PARTIAL DRAWS HEREUNDER, THE "STATED AMOUNT").

WE ARE INFORMED BY THE APPLICANT THAT THIS LETTER OF CREDIT IS BEING ISSUED PURSUANT TO THAT CERTAIN LETTER OF INTENT, DATED AS OF [INSERT DATE], BETWEEN THE [APPLICANT/ACCOUNT PARTY] AND THE BENEFICIARY (TOGETHER WITH ITS SUCCESSORS AND PERMITTED ASSIGNS, "BUYER") (SUCH LETTER OF INTENT, AS MAY BE AMENDED, SUPPLEMENTED OR OTHERWISE MODIFIED FROM TIME TO TIME, THE "AGREEMENT").

THIS LETTER OF CREDIT IS ISSUED, PRESENTABLE AND PAYABLE AT OUR OFFICE LOCATED AT [INSERT PHYSICAL ADDRESS OF BANK'S COUNTERS] AND, EXCEPT AS PROVIDED BELOW, EXPIRES WITH OUR CLOSE OF BUSINESS ON [INSERT DATE THAT IS AT LEAST 364 DAYS AFTER THE EFFECTIVE DATE OF L/C] (AS MAY BE EXTENDED AS PROVIDED BELOW, THE "EXPIRATION DATE").

IT IS A CONDITION OF THIS LETTER OF CREDIT THAT IT SHALL BE DEEMED AUTOMATICALLY EXTENDED WITHOUT WRITTEN AMENDMENT FOR A PERIOD OF ONE (1) YEAR FROM THE INITIAL EXPIRATION DATE, AND THEREAFTER FOR ONE YEAR FROM EACH FUTURE EXPIRATION DATE, UNLESS, AT LEAST SIXTY (60) DAYS PRIOR TO THE THEN APPLICABLE EXPIRATION DATE, WE NOTIFY YOU IN WRITING BY REGISTERED MAIL, RETURN RECEIPT REQUESTED, OR COURIER SERVICE THAT WE ELECT NOT TO CONSIDER THIS LETTER OF CREDIT EXTENDED BEYOND THE THEN APPLICABLE EXPIRATION DATE.

THIS LETTER OF CREDIT SHALL FINALLY EXPIRE ON [INSERT DATE THAT IS AT LEAST ONE YEAR AFTER THE INITIAL EXPIRATION DATE OF L/C], IF IT HAS NOT PREVIOUSLY EXPIRED IN ACCORDANCE WITH THE PRECEDING PARAGRAPH.

FUNDS IN PAYMENT OF A DRAWING UNDER THIS LETTER OF CREDIT ARE AVAILABLE TO THE BENEFICIARY BY PAYMENT AT SIGHT AGAINST PRESENTATION AT OUR OFFICE STIPULATED HEREIN ABOVE OF THE BENEFICIARY'S APPROPRIATELY COMPLETED SIGHT DRAFT(S) IN THE FORM OF EXHIBIT 1 ATTACHED HERETO AND DRAWING CERTIFICATE(S) IN THE FORM OF EXHIBIT 2 ATTACHED HERETO, EACH PURPORTEDLY BEARING THE SIGNATURE OF AN AUTHORIZED PERSON FOR THE BENEFICIARY (COLLECTIVELY, THE "DRAWING DOCUMENTS").

WE SHALL HAVE A REASONABLE AMOUNT OF TIME, NOT TO EXCEED TWO (2) BUSINESS DAYS FOLLOWING THE DATE OF OUR RECEIPT OF THE DRAWING DOCUMENTS, TO EXAMINE SUCH DRAWING DOCUMENTS AND DETERMINE WHETHER TO HONOR OR DISHONOR SUCH DRAWING DOCUMENTS AND TO INFORM YOU ACCORDINGLY. WE MAY DISHONOR SUCH DRAWING DOCUMENTS ONLY IF THEY DO NOT COMPLY WITH THE TERMS OF THIS LETTER OF CREDIT. WE HAVE NO DUTY OR RIGHT TO INQUIRE INTO THE VALIDITY OF, OR THE BASIS FOR, ANY DRAW. ANY NOTICE OF DISHONOR SHALL STATE ALL DISCREPANCIES UPON WHICH OUR DISHONOR IS BASED.

PARTIAL AND MULTIPLE DRAWINGS ARE PERMITTED HEREUNDER. ANY DRAWING HONORED HEREUNDER BY THE ISSUER SHALL REDUCE THE STATED AMOUNT AVAILABLE FOR DRAWINGS BY THE AMOUNT OF ANY DRAWING HONORED BY THE ISSUER. PRESENTATION OF DEMANDS FOR AMOUNTS IN EXCESS OF THE AMOUNT OF THIS LETTER OF CREDIT ARE ACCEPTABLE AND NOT DISCREPANT FOR THAT REASON; HOWEVER, THE AMOUNT PAYABLE ON ANY SUCH DEMAND WILL NOT EXCEED THE AMOUNT AVAILABLE UNDER THIS LETTER OF CREDIT.

WE HEREBY ENGAGE WITH YOU THAT ALL DOCUMENTS PRESENTED IN COMPLIANCE WITH THE TERMS OF THIS LETTER OF CREDIT SHALL BE DULY HONORED IF PRESENTED FOR PAYMENT ON OR BEFORE THE EXPIRATION DATE.

THIS LETTER OF CREDIT IS NOT TRANSFERABLE EXCEPT AS SET FORTH IN THIS PARAGRAPH. THIS LETTER OF CREDIT (INCLUDING THE DRAWING RIGHTS HEREUNDER) IS TRANSFERABLE BY THE BENEFICIARY, INCLUDING AS COLLATERAL FOR INDEBTEDNESS OF THE BUYER OUTSTANDING FROM TIME TO TIME, AND MAY BE SUCCESSIVELY TRANSFERRED. BY OUR EXECUTION AND DELIVERY OF THIS LETTER OF CREDIT, WE ALSO HEREBY ACKNOWLEDGE AND CONSENT, WITHOUT FURTHER CONDITIONS, TO YOUR PRESENT OR FUTURE ASSIGNMENT OF THE PROCEEDS OF ANY DRAWING UNDER THIS LETTER OF CREDIT. TRANSFER OF THIS LETTER OF CREDIT (INCLUDING THE DRAWING RIGHTS HEREUNDER), OR AN ASSIGNMENT OF THE PROCEEDS OF ANY DRAWING HEREUNDER, TO A TRANSFEREE SHALL BE EFFECTED, WITH NO OTHER CONDITIONS, BY THE PRESENTATION TO US OF AN APPROPRIATELY COMPLETED CERTIFICATE SUBSTANTIALLY IN THE FORM OF EXHIBIT 3 ATTACHED HERETO PURPORTEDLY BEARING THE SIGNATURE OF AN AUTHORIZED PERSON FOR THE BENEFICIARY. UPON RECEIPT OF ANY SUCH CERTIFICATE, WE UNDERTAKE TO PROMPTLY EXECUTE THE CONFIRMATION SET FORTH AT THE END OF SUCH CERTIFICATE AND FORWARD THE SAME DIRECTLY TO THE TRANSFEREE (PROVIDED THAT SUCH CONFIRMATION SHALL NOT BE A CONDITION TO THE TRANSFER). WE HAVE NO DUTY OR RIGHT TO INQUIRE INTO WHETHER ANY TRANSFEREE OF THIS LETTER OF CREDIT (INCLUDING THE DRAWING RIGHTS HEREUNDER) IS BUYER'S PERMITTED ASSIGNEE UNDER THE AGREEMENT AND MAY RELY EXCLUSIVELY ON YOUR CERTIFICATE.

ALL BANKING CHARGES ASSOCIATED WITH THIS LETTER OF CREDIT ARE FOR THE ACCOUNT OF THE APPLICANT.

AS USED HEREIN, "BUSINESS DAY" MEANS (I) ANY DAY OTHER THAN A SATURDAY, SUNDAY OR A DAY ON WHICH BANKS IN THE STATE OF NEW YORK ARE AUTHORIZED OR REQUIRED TO BE CLOSED, AND (II) ANY DAY ON WHICH PAYMENTS CAN BE EFFECTED ON THE FEDWIRE SYSTEM.

THIS LETTER OF CREDIT IS GOVERNED BY THE INTERNATIONAL STANDBY PRACTICES, INTERNATIONAL CHAMBER OF COMMERCE (ICC) PUBLICATION NO. 590 ("ISP98"), EXCEPT TO

THE EXTENT THAT THE TERMS OF THIS LETTER OF CREDIT ARE INCONSISTENT WITH THE PROVISIONS OF THE ISP98, IN WHICH CASE THE TERMS OF THIS LETTER OF CREDIT SHALL GOVERN. AS TO MATTERS NOT ADDRESSED BY THE ISP98, AND TO THE EXTENT NOT INCONSISTENT WITH THE ISP98 OR THE TERMS OF THIS LETTER OF CREDIT, THIS LETTER OF CREDIT SHALL BE GOVERNED BY AND CONSTRUED IN ACCORDANCE WITH THE LAWS OF THE STATE OF NEW YORK (INCLUDING, WITHOUT LIMITATION, ARTICLE 5 OF THE UNIFORM COMMERCIAL CODE OF THE STATE OF NEW YORK) AND APPLICABLE U.S. FEDERAL LAW.

THIS LETTER OF CREDIT, INCLUDING THE EXHIBITS HERETO, SETS FORTH IN FULL THE TERMS OF OUR UNDERTAKING AND SUCH UNDERTAKING SHALL NOT IN ANY WAY BE MODIFIED, AMENDED OR AMPLIFIED BY REASON OF OUR REFERENCE TO ANY AGREEMENTS OR INSTRUMENT REFERRED TO OR IN WHICH THIS LETTER OF CREDIT IS REFERRED TO. ANY SUCH AGREEMENTS OR INSTRUMENT SHALL NOT BE DEEMED INCORPORATED HEREIN BY REFERENCE.

SINCERELY,

\_\_\_\_\_  
[ISSUING BANK]

NAME: \_\_\_\_\_

TITLE: \_\_\_\_\_

**EXHIBIT 1**

**[BENEFICIARY LETTERHEAD]**

**SIGHT DRAFT**

[DATE]

[BANK NAME AND ADDRESS]

RE: IRREVOCABLE STANDBY LETTER OF CREDIT NUMBER \_\_\_\_\_

FOR THE VALUE RECEIVED, PAY TO THE ORDER OF \_\_\_\_\_ BY WIRE TRANSFER OF IMMEDIATELY AVAILABLE FUNDS TO THE FOLLOWING ACCOUNT:

[NAME OF ACCOUNT]  
[ACCOUNT NUMBER]  
[NAME AND ADDRESS OF BANK AT WHICH ACCOUNT IS MAINTAINED]  
[ABA NUMBER]  
[REFERENCE]

THE FOLLOWING AMOUNT:

[INSERT NUMBER OF DOLLARS IN WRITING] UNITED STATES DOLLARS  
(US\$ [INSERT NUMBER OF DOLLARS IN FIGURES])

DRAWN UPON YOUR LETTER OF CREDIT NO. \_\_\_\_\_ DATED  
[\_\_\_\_\_].

[INSERT NAME OF THE BENEFICIARY]

BY: \_\_\_\_\_

NAME: \_\_\_\_\_

TITLE: \_\_\_\_\_

**EXHIBIT 2**

**DRAWING CERTIFICATE**

[DATE]

[BANK NAME AND ADDRESS]

RE: IRREVOCABLE STANDBY LETTER OF CREDIT NUMBER \_\_\_\_\_

LADIES AND GENTLEMEN:

THE UNDERSIGNED, A DULY AUTHORIZED OFFICER OF [\_\_\_\_\_] (THE "BENEFICIARY"), AS THE BENEFICIARY OF THE ABOVE-REFERENCED LETTER OF CREDIT (THE "LETTER OF CREDIT"), HEREBY CERTIFIES TO [\_\_\_\_\_] (THE "ISSUER") WITH RESPECT TO THE LETTER OF CREDIT (THE TERMS DEFINED THEREIN AND NOT OTHERWISE DEFINED HEREIN BEING USED HEREIN AS THEREIN DEFINED) THAT:

1. THE [APPLICANT/ACCOUNT PARTY], [\_\_\_\_\_] AND BUYER ARE PARTIES TO THE AGREEMENT.

[PICK ONE OF THE FOLLOWING ALTERNATIVES FOR PARAGRAPH 2]<sup>1</sup>

[2. THE DRAW AMOUNT (AS DEFINED BELOW) IS DUE AND OWING BY THE APPLICANT TO THE BENEFICIARY UNDER THE TERMS OF THE AGREEMENT.] OR

[2. A BREACH BY THE ACCOUNT PARTY HAS OCCURRED UNDER THE AGREEMENT.] OR

[2. THE LETTER OF CREDIT WILL EXPIRE ON OR BEFORE THIRTY (30) DAYS AFTER THE DATE OF THIS CERTIFICATE AND THE APPLICANT HAS FAILED TO DELIVER TO BENEFICIARY A REPLACEMENT LETTER OF CREDIT OR EXTEND THE LETTER OF CREDIT IN ACCORDANCE WITH THE AGREEMENT AND SECURITY IS STILL REQUIRED UNDER THE AGREEMENT.]

3. THE BENEFICIARY IS ENTITLED TO MAKE A DRAWING UNDER THE LETTER OF CREDIT IN THE AMOUNT OF \$\_\_\_\_\_ (THE "DRAW AMOUNT") [INSERT BRACKETED

---

<sup>1</sup>If the Letter of Credit is issued, in whole or in part, in support of a Developmental Resource that has failed to meet the requirements of Appendix D, the following will be added to the listed alternatives:

2. THE BIDDER HAS CANCELLED, WITHDRAWN, OR MATERIALLY MODIFIED THE PROPOSAL(S) SUPPORTED BY THE LETTER OF CREDIT OR HAS OTHERWISE ELECTED TO TERMINATE ITS PARTICIPATION IN THE 2016 REQUEST FOR PROPOSALS FOR LONG-TERM RENEWABLE GENERATION RESOURCES FOR ENTERGY NEW ORLEANS, INC., DATED AS OF JULY 13, 2016, ISSUED BY ENTERGY SERVICES, INC. (AS MAY BE MODIFIED FROM TIME TO TIME, THE "RFP"), IT BEING UNDERSTOOD THAT "BIDDER" FOR THIS PURPOSE IS THE ACCOUNT PARTY OR THE PERSON ON WHOSE BEHALF THE ACCOUNT PARTY POSTED THE LETTER OF CREDIT.]

[2. ESI HAS TERMINATED BIDDER'S PARTICIPATION IN THE RFP DUE TO INTENTIONAL MISCONDUCT, FRAUD, OR OTHER ACTIONS OR INACTIONS OF BIDDER (OR ON BEHALF OF BIDDER) THAT ESI HAS DETERMINED, IN ITS GOOD FAITH JUDGMENT, IN CONSULTATION WITH THE IM, WERE TAKEN (OR NOT TAKEN) IN BAD FAITH, IT BEING UNDERSTOOD THAT "BIDDER" FOR THIS PURPOSE IS THE ACCOUNT PARTY OR THE PERSON ON WHOSE BEHALF THE ACCOUNT PARTY POSTED THE LETTER OF CREDIT.]



*LANGUAGE IF THE BENEFICIARY IS NOT THE SAME AS BUYER*[, AND THE BENEFICIARY IS MAKING SUCH DRAWING FOR THE BENEFIT OF BUYER].

IN WITNESS WHEREOF, THE UNDERSIGNED HAS EXECUTED THIS DRAWING CERTIFICATE AS OF THE \_\_\_\_ DAY OF \_\_\_\_\_ 20\_\_.

*[INSERT NAME OF THE BENEFICIARY]*

BY: \_\_\_\_\_  
NAME: \_\_\_\_\_  
TITLE: \_\_\_\_\_

**EXHIBIT 3**

**FORM OF TRANSFER NOTICE**

[DATE]

[BANK NAME AND ADDRESS]

RE: IRREVOCABLE STANDBY LETTER OF CREDIT NUMBER \_\_\_\_\_

LADIES AND GENTLEMEN:

REFERENCE IS MADE TO THAT CERTAIN IRREVOCABLE STANDBY LETTER OF CREDIT NO. \_\_\_\_\_ (THE "LETTER OF CREDIT") ISSUED BY YOU IN FAVOR OF \_\_\_\_\_ (THE "BENEFICIARY") ON BEHALF OF \_\_\_\_\_ ("APPLICANT"). THIS TRANSFER NOTICE IS PRESENTED UNDER THE LETTER OF CREDIT. CAPITALIZED TERMS NOT OTHERWISE DEFINED IN THIS TRANSFER NOTICE HAVE THE MEANINGS GIVEN TO THEM IN THE LETTER OF CREDIT.

FOR VALUE RECEIVED, THE BENEFICIARY HEREBY IRREVOCABLY ASSIGNS TO:

NAME OF TRANSFEREE:  
ADDRESS:

ALL RIGHTS OF THE UNDERSIGNED BENEFICIARY [PICK FIRST ALTERNATIVE FOR FULL ASSIGNMENT AND SECOND ALTERNATIVE FOR ASSIGNMENT OF PROCEEDS] [UNDER THE LETTER OF CREDIT IN ITS ENTIRETY] [TO THE PROCEEDS OF ANY DRAWINGS UNDER THE LETTER OF CREDIT, WHICH SHALL BE PAYABLE AS FOLLOWS: [INSERT ANY APPLICABLE PAYMENT INSTRUCTIONS]].

THIS ASSIGNMENT SHALL BE EFFECTIVE AS OF \_\_\_\_\_.

[INSERT ONLY FOR FULL ASSIGNMENT] [BY THIS TRANSFER, ALL RIGHTS OF THE UNDERSIGNED BENEFICIARY UNDER SUCH LETTER OF CREDIT ARE ASSIGNED TO THE TRANSFEREE AND THE TRANSFEREE SHALL HAVE THE SOLE RIGHTS AS BENEFICIARY THEREOF, INCLUDING SOLE RIGHTS RELATING TO ANY AMENDMENTS, WHETHER INCREASES OR EXTENSIONS OR OTHER AMENDMENTS AND WHETHER NOW EXISTING OR HEREAFTER MADE. ALL AMENDMENTS ARE TO BE ADVISED DIRECTLY TO THE TRANSFEREE WITHOUT NECESSITY OF ANY CONSENT OF OR NOTICE TO THE UNDERSIGNED BENEFICIARY.]

WE ASK YOU TO EXECUTE THE CONFIRMATION SET FORTH BELOW, AND FORWARD IT DIRECTLY TO THE TRANSFEREE.

IN WITNESS WHEREOF, THE UNDERSIGNED HAS EXECUTED THIS TRANSFER NOTICE AS OF THE \_\_\_\_\_ DAY OF \_\_\_\_\_ 20\_\_.

[INSERT NAME OF THE BENEFICIARY]

BY: \_\_\_\_\_  
NAME: \_\_\_\_\_  
TITLE: \_\_\_\_\_

IN WITNESS WHEREOF, THE UNDERSIGNED HAS EXECUTED THIS TRANSFER NOTICE AS OF THE \_\_\_\_\_ DAY OF \_\_\_\_\_ 20\_\_, AND HEREBY CONFIRMS THE ASSIGNMENT OF THE LETTER OF CREDIT TO THE TRANSFEREE REFERENCED ABOVE.

[INSERT BANK NAME]

BY: \_\_\_\_\_  
NAME: \_\_\_\_\_  
TITLE: \_\_\_\_\_



***Appendix G***

***Process For  
Protection of Proposal Information***

***For***

***2016 Request For Proposals***

***For***

***Long-Term Renewable  
Generation Resources***

***For***

***Entergy New Orleans, Inc.***

Entergy Services, Inc.  
July 13, 2016

The statements contained in this Appendix are made subject to the Reservation of Rights set forth in Appendix E of the RFP and subject to the terms and acknowledgements set forth in the Proposal Submission Agreement.

## APPENDIX G

### PROCESS FOR PROTECTION OF PROPOSAL INFORMATION

This Appendix G describes the process ESI will follow to ensure that information provided by Bidders in this RFP is kept confidential and not improperly disclosed to or used by any employee, consultant, or other representative of ESI or any other Affiliate of ESI. Additionally, this Appendix G outlines ESI's process for evaluating proposals submitted in response to this RFP in a manner that affords objective and impartial treatment to all Bidders, including self-build projects,<sup>1</sup> and complies with all applicable legal and regulatory requirements, including applicable Affiliate Rules.

#### OVERVIEW

This Appendix G details various mechanisms ESI has developed and installed to protect the confidentiality of Bidder's information in the RFP process and to achieve the additional objectives identified in the opening paragraph above, including:

- (1) Use of an Independent Monitor (IM);
- (2) Reliance upon an RFP Administrator;
- (3) Reliance upon an RFP Administration Team;
- (4) Adherence to protocols for Receipt of Bidder Registration Information;
- (5) Adherence to procedures for Receipt of Proposal Information and Protection of Confidentiality;
- (6) Adherence to protocols for Protection of Market-Sensitive Proposal Information;
- (7) Compliance with applicable Affiliate Rules; and
- (8) Adherence of Self-Build Commercial Team to Codes of Conduct.

#### 1. Use of Independent Monitor

ESI has retained the IM in order to (i) oversee the design and implementation of this RFP's solicitation, evaluation, selection, and contract negotiation process to ensure that the process is impartial and objective, (ii) help ensure that all proposals are treated in a consistent fashion and without undue preference given to any Bidder, including designated personnel responsible for developing the self-build option (including with respect to cost estimates, performance data, and other information related to such option), and (iii) otherwise assist ESI in its efforts to ensure that this RFP is conducted in a fair and impartial manner. The IM's role is described in the Scope of Work Activities, which is posted on the 2016 ENOI Renewables RFP Website.

---

<sup>1</sup> As specified in Section 1.7 of the Main Body, Entergy Competitive Affiliates are ineligible to participate in this RFP. Safeguards to ensure that confidential RFP information is not shared with Entergy Competitive Affiliates are discussed later in this Appendix G.

The statements contained in this Appendix are made subject to the Reservation of Rights set forth in Appendix E of the RFP and subject to the terms and acknowledgements set forth in the Proposal Submission Agreement.

**Appendix G**  
**Process for Protection of Proposal Information**

During each of the following phases in the RFP process, the IM will perform specific roles, as generally described below:

**1.1. RFP Process Design and Implementation.** The RFP process has been developed with the advice and oversight of the IM in an attempt to ensure that the RFP process is designed and implemented in a fair and impartial manner and is consistent with principles associated with a market-based procurement process.

**1.2. Proposal Review.** All proposals submitted by Bidders will be reviewed and screened by the IM. The IM will work with members of the RFP Administration Team to redact certain information from Bidders' proposals before being distributed to the Evaluation Teams. For each proposal, the IM and the RFP Administration Team will redact Bidder's name prior to the proposal's distribution to the Economic Evaluation Team and the pricing terms prior to the proposal's distribution to the Viability Assessment Team. The redactions are part of a process designed to protect Bidder confidentiality and to ensure that the evaluation of all proposals by the Evaluation Teams is impartial and that information that is or may be needed for review of the proposals is provided to the Evaluation Teams without the disclosure of proposal information to persons who do not need such information to perform their evaluation obligations. The IM will also oversee the segregation of information from Bidder's Proposal Package. After segregation, each Evaluation Team will receive and have access to only the information it needs to perform its portion of the proposal evaluation. The information segregation process is designed to protect Bidder confidentiality and ensure impartial evaluation of all proposals by the Evaluation Teams. While no process can ensure that a Bidder's identity remains completely anonymous, the review and redaction process was developed to provide the maximum reasonably practicable level of assurance of anonymity in order to maintain a fair and consistent evaluation process.

**1.3. Proposal Submission Process.** The IM, the RFP Administrator, and, as necessary, other members of the RFP Administration Team will oversee receipt of all proposals during the Proposal Submission Period. The IM, Authorized members of the RFP Administration Team, and the Evaluation Teams (as needed) will review information submitted by Bidders to determine whether the proposals meet the Threshold Requirements specified in Section 2.3 of the Main Body and whether additional information is needed or appropriate.

**1.4. Proposal Evaluation and Selection Process.** The IM will monitor the proposal evaluation and selection processes to ensure that the RFP process is objective and impartial and to ensure that all proposals are treated in a consistent fashion, and that no undue preference is provided to any Bidder, including the commercial team responsible for developing and submitting the self-build option (the "Self-Build Commercial Team"). In addition, the IM will review the measures taken to restrict access to proposal information to only those members of the Evaluation Teams who need such information for evaluation purposes.

The statements contained in this Appendix are made subject to the Reservation of Rights set forth in Appendix E of the RFP and subject to the terms and acknowledgements set forth in the Proposal Submission Agreement.

**Appendix G**  
**Process for Protection of Proposal Information**

**1.5. Oversight of Communications with Bidder.** During the period prior to the creation of the Primary Selection List and/or the Secondary Selection List, the IM will obtain and review in advance copies of all written communications from the RFP Administrator to Bidders. To the extent any Bidder is contacted pursuant to Section 2.2 of this Appendix G, the RFP Administrator will consult with the IM before initiating contact to minimize the dissemination of information that explicitly identifies Bidders to Evaluation Team members who do not need such information.

**1.6. Contract Negotiation and Due Diligence Phase.** After a Bidder has been notified of the inclusion of a proposal submitted on the Primary Selection List or the Secondary Selection List, the IM will monitor the status of developments relating to such proposals, including the status of negotiations of an LOI and/or a Definitive Agreement with such Bidder. If the self-build option is selected for the Primary Selection List, the IM will monitor and, as it deems appropriate, participate in any discussions between members of the Evaluation Team(s) and the Self-Build Commercial Team. If the self-build option is selected to the Secondary Selection List, unless and until the self-build option is selected to the Primary Selection List, the IM shall participate in all discussions between the Evaluation Team(s) and the Self-Build Commercial Team. The IM also may participate in negotiations with Bidders as it deems necessary.

**2. Role of RFP Administrator**

ESI has designated an individual to serve as the “RFP Administrator.” The RFP Administrator will serve, under the IM’s supervision, in a multi-purpose role that includes, but is not limited to, the following responsibilities:

**2.1. Responsibility as Liaison.** The RFP Administrator will serve as a liaison between all Bidders or potential Bidders and ESI regarding RFP-related matters.

**2.2. Processing of Questions.** In the event that ESI needs to contact a Bidder to clarify its proposal(s), to request additional information, or for other purposes contemplated by this RFP, the RFP Administrator will perform those functions and communicate directly with Bidders. The IM will obtain and review in advance copies of all written communications from ESI to Bidders. Bidders will be required to submit any written response to such communications to the RFP Administrator, who will engage the IM in accordance with Section 1.5 above before transmitting the information to the appropriate Evaluation Team.

**2.3. Responsibility for RFP Files.** The RFP Administrator will ensure that all RFP-related files and information are properly organized, stored, and secured so as to protect adequately the confidentiality of information in accordance with the processes and procedures described herein.

**3. Role of RFP Administration Team**

The statements contained in this Appendix are made subject to the Reservation of Rights set forth in Appendix E of the RFP and subject to the terms and acknowledgements set forth in the Proposal Submission Agreement.

**Appendix G**  
**Process for Protection of Proposal Information**

For this RFP, ESI has established an RFP Administration Team, which consists of (i) the RFP Administrator, (ii) the VP of System Planning for ESI, (iii) the Director of Planning Analysis for ESI, (iv) the Manager of Project and Performance Management for ESI, (v) the Director of Commercial Operations for ESI, (vi) the Manager of Financial Analysis for ESI, and (vii) the Director of Back Office and Support Services. None of the members of the RFP Administration Team are members of any Evaluation Team or the Self-Build Commercial Team. The role of the RFP Administration Team includes, but is not limited to, the following responsibilities:

**3.1. Responses to Bidder Questions.** The RFP Administration Team will ensure that Bidder questions received by the RFP Administrator concerning this RFP are addressed, with questions and answers posted on the 2016 ENOI Renewables RFP Website, subject to Section 7 of the Main Body.

**3.2. Distribution of Proposal Information.** The RFP Administration Team will ensure that proposal information is distributed to appropriate members of the RFP Evaluation Teams after review and approval by the IM.

**3.3. Provision of Assistance to IM.** The RFP Administration Team will work directly with the IM on all questions associated with a specific proposal and will assist the IM in an administrative capacity in support of the IM's efforts to ensure compliance with the processes and procedures contemplated by this RFP.

**4. Protocols for Receipt of Bidder Registration Information**

Bidders will register for this RFP in accordance with the instructions provided in Section 5.2 of the Main Body. Information submitted to ESI through the Bidder Registration Process will be submitted to the RFP Administrator. Only the IM, the RFP Administrator, and, if necessary, members of the RFP Administration Team will have access to and review the information received from Bidders in the Bidder Registration Process.

**5. Procedures for Receipt of Proposal Information and Protection of Confidentiality**

Bidders will be required to submit proposals responsive to this RFP in accordance with the instructions provided in Section 5.3 of the Main Body. A key process objective of the RFP process is to ensure that information provided by Bidders in response to this RFP is kept confidential. ESI has designed procedures, described in the Main Body, that its employees, agents, and consultants must follow in the proposal review and the proposal evaluation processes of this RFP. These procedures are designed to preserve, to the extent practicable, the confidentiality of any confidential information contained in Bidders' proposals. Procedural protections include requiring the submission, via electronic mail or courier, of Bidder's Proposal Packages to the RFP Administrator and the redaction of certain information in the Bidder Proposal Packages so that different members of the Economic Evaluation Team and the Viability Assessment Team receive the information needed to carry out

The statements contained in this Appendix are made subject to the Reservation of Rights set forth in Appendix E of the RFP and subject to the terms and acknowledgements set forth in the Proposal Submission Agreement.

**Appendix G**  
**Process for Protection of Proposal Information**

their respective evaluations. These procedures are intended to provide reasonable assurance to Bidders that, except as noted below with respect to legal or regulatory requirements, information contained in their proposals will be disclosed (i) only to the appropriate members of the Evaluation Teams, and (ii) only to select agents and consultants utilized by ESI/the Evaluation Teams, and only to the extent necessary for such agents and consultants to perform their respective functions in connection with this RFP.

**5.1. Basic Preliminary Protective Measures.** Immediately after the end of the Proposal Submission Period, each Proposal Package will be reviewed by the IM, who will work with members of the RFP Administration Team to review each Proposal Package and redact certain information from the Proposal Package before any information from the Proposal Package is given to any member of any Evaluation Team. The IM and the RFP Administration Team will review proposal information before its distribution to the Evaluation Teams and will endeavor to ensure that Bidder's name is redacted in the version of the proposal provided to the EET and the pricing terms are redacted in the version of the proposal distributed to the VAT.

Preliminary Executive Report

After completion of each of the Bidder Registration Process and the Proposal Submission Process, the IM may prepare an Executive Report (each a "**Preliminary Executive Report**"), which will communicate the following: (1) the total number of Bidders submitting proposals in this RFP; (2) the total number of resources for which proposals have been submitted in this RFP; (3) the total number of proposals and the total amount of Capacity offered in this RFP; (4) the total number of technologies for which proposals were submitted in this RFP, the total number of proposals submitted for each technology and resource, and the total amount of Capacity offered for each technology and resource; and (5) any additional information that the recipients of the Executive Report may request and that the IM concurs is appropriate to provide. Preliminary Executive Reports will be communicated only to the Entergy Operating Committee (provided the Entergy System Agreement has not been terminated or cancelled and is still in effect), the operating committee for ENOI, the Chief Executive Officer of Entergy Corporation, the Chief Executive Officer of ENOI, the Senior Vice President and Chief Accounting Officer of Entergy Corporation, the Executive Vice President and Chief Financial Officer of Entergy Corporation, the Executive Vice President and Chief Operating Officer of Entergy Corporation, the Group President of Utility Operations of Entergy Corporation, and, as needed and with the IM's concurrence, other senior executives of Entergy Corporation or any direct or indirect subsidiary thereof ("**Authorized Executive Report Recipients**").

Supplemental Executive Reports

After reviewing proposals for compliance with the Threshold Requirements or in connection with a decision to eliminate a proposal from this RFP, the IM may prepare an Executive Report (each a "**Supplemental Executive Report**") that will communicate the following with respect to the

The statements contained in this Appendix are made subject to the Reservation of Rights set forth in Appendix E of the RFP and subject to the terms and acknowledgements set forth in the Proposal Submission Agreement.



**Appendix G**  
**Process for Protection of Proposal Information**

proposals remaining in this RFP or the proposal(s) that have been or may be eliminated: (1) Proposal IDs; (2) capacity amount; (3) resource location; (4) if applicable, the generic basis for elimination of the proposal(s); and (5) any additional information that the recipients of the Supplemental Executive Report may request and that the IM concurs is appropriate to provide. Any Supplemental Executive Report will be communicated only to Authorized Executive Report Recipients.

**5.2. Proposal Data.** Proposal information will be segregated and distributed to the Evaluation Teams as follows:

- a) operational and economic information will be provided to members of the EET;
- b) technical, environmental, operational, commercial, and other information related to the viability of the proposal will be provided to members of the VAT;
- c) reliability, production cost input, resource location, electric interconnection, and network deliverability information will be provided to the DAT members of the VAT;
- d) information relevant to assessing accounting treatment and effects of the proposal will be provided to members of the AET; and
- e) credit information will be provided to members of the CET.

The proposal information described above will be provided only as needed for the Evaluation Team to perform the specified evaluation functions for which it is responsible. The proposal information provided to the Evaluation Teams may exclude data specifically identifying the Bidder (Bidder company name, Bidder company address, Bidder company contact information, etc.). The IM will work with members of the RFP Administration Team to redact Bidder's proposal information prior to providing it to the appropriate Evaluation Teams. While no process can ensure that Bidder's identity remains completely anonymous, the intention of the foregoing process is to provide the maximum reasonably practicable level of assurance of anonymity in order to maintain a fair and consistent evaluation process. As described above, the IM will review all proposal information prior to distribution to members of the Evaluation Teams. During proposal evaluation, each proposal will be identified by its unique Bidder ID, Proposal ID and/or Resource ID.

**5.3. Evaluation Team Reports.** The Evaluation Teams will prepare reports informed by results of their analysis of the proposals. The Evaluation Team reports will be reviewed by the RFP Administration Team, the IM, and by senior advisors and other decision-makers at ESI and ENOI. If and after a proposal has been selected for the Primary Selection List or the Secondary Selection List, all information relating to such proposal may be made available to the team or individuals tasked with negotiating the Definitive Agreement, to appropriate executives and other decision-makers at ESI and ENOI, and, with the IM's concurrence, to the Economic Evaluation Team. ESI reserves the

The statements contained in this Appendix are made subject to the Reservation of Rights set forth in Appendix E of the RFP and subject to the terms and acknowledgements set forth in the Proposal Submission Agreement.

**Appendix G**  
**Process for Protection of Proposal Information**

right to disclose, with the IM's concurrence, proposal information to additional ESI personnel as necessary to address unforeseen circumstances that may materialize and materially affect the evaluation of one or more of the proposals received in this RFP. Without limiting Section 5.5 below, all Entergy personnel and other agents and consultants having access to confidential information in this RFP will be contractually and/or professionally bound to protect the confidentiality of confidential Bidder information and to use it for no purpose other than activities related to the RFP process and resource evaluation processes. Notwithstanding the foregoing, and without limiting Appendix E, ESI and ENOI expressly disclaim and have no liability to any Bidder for damages of any kind resulting from any disclosure of any Bidder or proposal information.

**5.4. Post-RFP Treatment of Proposals and Related Information.** Proposals and any correspondence or other material (including electronic material) provided to ESI in connection with this RFP will not be returned to Bidders. At the conclusion of the RFP process (including regulatory review of any transaction entered into as a result of this RFP), all proposals will be either destroyed or archived by ESI in accordance with internal policies governing the storage and retention of records and subject to the procedures described in this section providing for the treatment of such proposals as confidential and subject to any applicable Affiliate Rules.

**5.5. Certain Permitted Disclosures of Proposal Information.** All information contained in a proposal or otherwise provided by Bidder to ESI in connection with this RFP may be: (i) required to be disclosed by ESI or ENOI pursuant to any applicable law, rule, or regulation or in any proceeding or review, audit, or investigation involving ESI or ENOI and (ii) subject to review by one or more of the regulatory bodies, including their staffs, having jurisdiction over ESI or ENOI in connection with any proceeding, audit, or investigation involving ESI or ENOI, or by any other Governmental Authority with jurisdiction over ESI or ENOI over any matter related to or affected by, directly or indirectly, this RFP, and may be subject to legal discovery or disclosure. By submitting a proposal in this RFP, and subject to any less restrictive terms included in any confidentiality agreement entered into by ESI or ENOI and Bidder (or party on whose behalf Bidder submitted its proposal), Bidder agrees to (a) allow ESI and ENOI to use any of the information contained in any of its proposals or otherwise submitted to ESI in connection with this RFP in filings, pleadings, responses to information requests, testimony, or evidence in any proceeding before or review, audit, or investigation involving any such regulatory body or other Governmental Authority and, without limiting the generality of the foregoing, (b) disclose any of such information when required to do so as described above. In the event such information is to be so disclosed, ESI or ENOI, as applicable, will use good faith efforts to attempt to obtain from such Governmental Authority (or other Person to whom such disclosure is being made), prior to the disclosure of such information, a confidentiality agreement or protective order or other mechanism to protect the confidentiality of such information and limit its dissemination. ESI and ENOI can provide and makes no assurance of the outcome of any such attempt. ESI advises Bidders that intervenors have sought access to confidential Bidder information about potential resource acquisitions in prior regulatory proceedings relating to previous ESI requests for proposals or in which ENOI has been involved, and similar requests for access could be made in proceedings relating to this RFP.

The statements contained in this Appendix are made subject to the Reservation of Rights set forth in Appendix E of the RFP and subject to the terms and acknowledgements set forth in the Proposal Submission Agreement.

**Appendix G**  
**Process for Protection of Proposal Information**

**6. Protocols for Protection of Market-Sensitive Proposal Information**

Because numerous departments and personnel in the ESI organization are involved in the resource planning, asset management/supply procurement, and operations functions, ESI has implemented specific protocols for the protection of proposal information to limit access to specific market-sensitive proposal information provided by Bidders in this RFP, including the protocols listed below:

- (i) No proposal information shall ever be disclosed to any Entergy Competitive Affiliate or to members of the Self-Build Commercial Team, except to the extent that such information is made public.
- (ii) Subject to Section 5.1 and 5.2 above, prior to the selection of proposals to the Primary Selection List and the Secondary Selection List, no proposal information shall be provided to any person within ESI who is not a member of an RFP Evaluation Team or the RFP Administration Team, other than the information that may be provided to counsel for confidential legal analysis involving such information and to senior advisors and decision-makers at ESI and ENOI as provided for in Section 5.3 above.
- (iii) No proposal information shall be provided to any member of an Evaluation Team prior to the Proposal Submission Deadline or before review and approval by the IM.
- (iv) All files created in connection with the RFP process shall be available only to approved personnel. Approved personnel will include only the IM, members of the RFP Administration Team, and those of the Evaluation Teams with designated access to the subject information.
- (v) ESI management is responsible for communicating to the members of the Evaluation Teams the importance of compliance with these protocols, both at the outset of the RFP process and on a continuing basis.
- (vi) ESI personnel involved with the RFP process shall sign a confidentiality acknowledgement that governs access to and uses of information contained in proposals and proposal documents or shall be professionally bound to protect the confidentiality of confidential Bidder information and to use it for no purpose other than activities related to the RFP process and resource evaluation processes.

For the avoidance of doubt, the foregoing protocols will be subject to Section 5.5 above.

**7. Affiliate Rules**

The statements contained in this Appendix are made subject to the Reservation of Rights set forth in Appendix E of the RFP and subject to the terms and acknowledgements set forth in the Proposal Submission Agreement.

**Appendix G**  
**Process for Protection of Proposal Information**

All employees of ESI, any Entergy Operating Company, or any Entergy Competitive Affiliate must adhere to the following Affiliate Rules, as applicable:

- i. FERC Transmission Standards of Conduct, codified at 18 CFR § 358;
- ii. FERC Market-Based Rate Affiliate Restrictions, codified at 18 CFR § 35.39;
- iii. FERC Cross-Subsidization Restrictions on Affiliate Transactions, codified at 18 CFR §§ 35.43-44;
- iv. Arkansas Affiliate Transaction Rules, as applicable;
- v. Texas Affiliate Transaction Rules, as applicable;
- vi. Council for the City of New Orleans Code of Conduct for Entergy New Orleans, Inc.;
- vii. October 1992 Settlement Agreement between Entergy and the Arkansas Public Service Commission;
- viii. Appendix 3 to the Louisiana Public Service Commission's May 3, 1993, Order No. U-19904;
- ix. March 26, 1998, Settlement Agreement between Entergy and the Council for the City of New Orleans;
- x. April 10, 1998, Settlement Agreement between Entergy and the Mississippi Public Service Commission;
- xi. October 19, 2000, Gas Settlement Agreement between the Council for the City of New Orleans and Entergy New Orleans, Inc.; and
- xii. Entergy Corporation Standards of Conduct regarding the relationship between Entergy Corporation's regulated and unregulated subsidiaries.

A link to these Affiliate Rules is posted on the 2016 ENOI Renewables RFP Website.

**8. Code of Conduct for Self-Build Commercial Team**

The Self-Build Commercial Team will adhere to the provisions of an Acknowledgement of Confidentiality, which will require, among other things, that the members of the Self-Build Commercial Team refrain from participation in the RFP evaluation process.

The statements contained in this Appendix are made subject to the Reservation of Rights set forth in Appendix E of the RFP and subject to the terms and acknowledgements set forth in the Proposal Submission Agreement.



***Appendix H***

***Form Distribution Interconnection  
Process Documentation***

***For***

***2016 Request For Proposals***

***For***

***Long-Term Renewable  
Generation Resources***

***For***

***Entergy New Orleans, Inc.***

Entergy Services, Inc.  
July 13, 2016

## **APPENDIX H**

### **FORM DISTRIBUTION INTERCONNECTION PROCESS DOCUMENTATION**

Exhibits H-1, H-2, and H-3 contained within Appendix H, describe detailed information about the interconnection process for resources seeking to interconnect at a distribution service level, including applications for service. Additional information regarding distribution-level interconnection applications can be found in the Main Body sections 2.4 and 2.4.1.

Exhibit H-1, “Connecting Small Electric Generators to the Entergy Distribution System (less than 300kVA),” describes the requirements and procedures for safe and effective connection and operation of electric generators smaller than 300kV on the Company Distribution electric grid.

Exhibit H-2, “Connecting Large Electric Generators to the Entergy Distribution System (300kVA to 20MVA),” describes the requirements and procedures for safe and effective connection and operation of electric generators 300kVA to 20MVA on the Entergy Distribution electric system.

Exhibit H-3, “Distribution Inter-Connection Process,” describes the overall process for queuing, processing, executing, and maintaining Interconnection Agreements for Generators 20MW and smaller in size connecting to the Entergy System via Distribution.

**Exhibit H-1**

**Connecting Small Electric Generators to the Energy Distribution System  
(less than 300kVA)**



Title: Connecting Small Electric Generators to the Entergy Distribution System (less than 300kVA)		Effective Date: <b>May 04, 2016</b>
Prepared By: Michael R. Gray Distribution Design Basis / Standards	Approved By: James R. Hickman Manager of Distribution Design Basis / Standards	

## Contents

<b>1</b>	<b>INTRODUCTION.....</b>	<b>3</b>
<b>1.1</b>	<b>PURPOSE .....</b>	<b>3</b>
1.1.1	<i>Operating Agreement Requirements.....</i>	<i>3</i>
1.1.2	<i>Explicit Criteria for Parallel Operations.....</i>	<i>4</i>
<b>1.2</b>	<b>SCOPE.....</b>	<b>5</b>
<b>2</b>	<b>DEFINITIONS.....</b>	<b>6</b>
<b>3</b>	<b>DETAILS .....</b>	<b>9</b>
<b>3.1</b>	<b>AVAILABLE VOLTAGE SYSTEMS.....</b>	<b>9</b>
<b>3.2</b>	<b>MANUALLY OPERATED LOAD BREAK SWITCH /LABELING/ REASONS FOR DISCONNECT FROM THE DISTRIBUTION DELIVERY SYSTEM .....</b>	<b>9</b>
3.2.1	<i>Manually Operated Load Break Switch.....</i>	<i>9</i>
3.2.2	<i>Labels.....</i>	<i>9</i>
3.2.3	<i>Reasons for Disconnect from the Distribution Delivery System.....</i>	<i>10</i>
<b>3.3</b>	<b>ELECTRICAL CURRENT AND VOLTAGE OF EXISTING SERVICE.....</b>	<b>10</b>
<b>3.4</b>	<b>SYSTEM CHANGES .....</b>	<b>11</b>
3.4.1	<i>Company Changes to Distribution Delivery System.....</i>	<i>11</i>
3.4.2	<i>Customer Changes to Interconnection.....</i>	<i>11</i>
<b>3.5</b>	<b>ALLOWABLE TIE POINTS.....</b>	<b>11</b>
<b>3.6</b>	<b>ENERGY FLOW DURING EMERGENCIES .....</b>	<b>11</b>
<b>3.7</b>	<b>TYPES OF ALLOWED GENERATORS .....</b>	<b>11</b>
<b>3.8</b>	<b>GENERAL INTERCONNECTION REQUIREMENTS.....</b>	<b>11</b>
3.8.1	<i>Customer’s Equipment and Interconnection Standards.....</i>	<i>11</i>
3.8.2	<i>Rating of Customer’s Equipment.....</i>	<i>12</i>
3.8.3	<i>Protection of Customer’s Equipment.....</i>	<i>12</i>
3.8.4	<i>Required Drawings.....</i>	<i>12</i>
3.8.5	<i>Changes to Company Facilities.....</i>	<i>12</i>
3.8.6	<i>Power Factor .....</i>	<i>13</i>
3.8.7	<i>Reactive Power Requirements.....</i>	<i>13</i>
3.8.8	<i>Voltage Surges or Sags.....</i>	<i>13</i>
3.8.9	<i>Voltage Flicker, Harmonic Distortion, Transients and other Power Quality Issues .....</i>	<i>13</i>
3.8.10	<i>Frequency .....</i>	<i>14</i>
3.8.11	<i>Interconnected Electric Generators in Central Business District Grids.....</i>	<i>14</i>
<b>3.9</b>	<b>INSPECTION PRIOR TO OPERATIONS AND ADDITIONAL REQUIREMENTS .....</b>	<b>14</b>
<b>3.10</b>	<b>RESPONSIBILITY FOR CUSTOMER’S OPERATIONS .....</b>	<b>15</b>
<b>3.11</b>	<b>RESPONSIBILITY FOR CUSTOMER’S ANNUAL MAINTENANCE.....</b>	<b>15</b>

This document is the property of Entergy Services, Inc. and contains confidential and proprietary information owned by Entergy Services, Inc. Any copying, use, or disclosure of this information without the written permission of Entergy Services, Inc. is strictly prohibited. This material is protected under trade secret and unfair competition laws and the expression of the information contained herein is protected under Federal copyright laws. Violations thereof may result in criminal penalties and fines.



**3.12 PROTECTION/INTERFACE REQUIREMENTS ..... 15**

    3.12.1 *Changes to Company Fault Interruption Equipment..... 15*

    3.12.2 *Tests of the Customer’s Equipment ..... 16*

    3.12.3 *Requirements for Specific Technologies..... 16*

**3.13 SYNCHRONIZING REQUIREMENTS ..... 17**

**3.14 METERING REQUIREMENTS ..... 17**

**4 REFERENCES ..... 18**

**5 FLOW CHARTS (ONE LINE DIAGRAMS)..... 19**

**6 REVISIONS ..... 21**

## 1 Introduction

### 1.1 Purpose

A Customer may operate an Electric Generator at 60 Hertz (Hz), single- or three-phase at voltages up to and including 34.5 kV in parallel with the Company's Distribution Delivery System provided that the equipment meets or exceeds the requirements of Company standards.

The purpose of this standard is to describe the **requirements and procedures for safe and effective connection and operation of electric generators smaller than 300kVA** on the Company Distribution electric grid. Customers who have 300kVA to 20MVA generators to connect should refer to *Connecting Large Electric Generators to the Entergy Distribution System*. Customers larger than 20MVA or who would interconnect at Transmission level voltages (69 kV and above) should contact Entergy Transmission. Cost of interconnect, service, payment for electricity and other economic considerations are regulated by the governing Public Service Commission.

Special Rates are allowed by Utility Regulators for consumers who own and interconnect (generally small) renewable energy facilities, such as wind, solar power or home fuel cells. In some areas this is called Net Metering. . Consult the Entergy webpage of your franchise or the appropriate Public utility for details. (These Customers are described by Case 5 in Section 1.2 Scope)

If they do not meet the requirements above or want another option, FERC Qualifying facilities or small power producers also have special rates in each jurisdiction allowing them to sell power to the Company at avoided cost. Agreement from the Company is required to inject Electric Power onto the Company Distribution System.

**The process of Connection is started by a Customer submitting a completed Application (Available on the internet. Go to [www.entergy.com](http://www.entergy.com), select your state or jurisdiction, select residential and select Net Metering or contact 1 800 ENTERGY.) The Customer may request the vendor of the equipment or the electrician help fill out the application.** The third step is to contact your local Entergy Representative or call 1-800-ENTERGY to get a representative assigned.

#### 1.1.1 Operating Agreement Requirements

A written agreement (which is available from your Company Representative and on the Internet) will be required between the Company and the Customer specifying the liability provisions, indemnities, terms of payment of cost to modify Distribution Delivery System (if not paid in advance), and other items affecting service under this document. This agreement will explain in detail the authority

or responsibilities of the parties involved. **An Interconnection between the Company's Distribution Delivery System and a Customer's Electric Generator System will not be allowed prior to the execution of a written Standard Interconnection Agreement for the Facilities.**

Interconnected Electric Generators in Central Business District Grids is discussed in Section 3.8.11

### **1.1.2 Explicit Criteria for Parallel Operations**

Two objectives must be met to arrive at compliance by the proposed installation:

#### **1.1.2.1 Safety**

Customer's Electric Generators will be held to the same Standard of Care, as the Company is required to maintain. In addition, the safety of the general public and the personnel and equipment of the Company shall in no way be reduced or impaired as a result of the Interconnection.

- a Customer's Electrical Generator shall be equipped with Protective Functions designed to prevent the Generator from being connected to a de-energized circuit owned by the Company.
- b Customer's Electrical Generation Facility shall be equipped with the necessary Protective Functions designed to prevent connection or Parallel Operation of the Customer's facility with the Distribution Delivery System unless the Distribution Delivery System service voltage and frequency are of normal magnitude. The design of some systems provides these functions without adding equipment at the Point of Common Coupling (PCC). Each system not providing additional devices at the PCC must be shown to be capable of these functions.

#### **1.1.2.2 Customer Impact**

The quality, reliability and the availability of service to the Company's other Customers shall not be diminished or impaired as a result of the Interconnection.

This standard describes typical connection requirements. Some installations, however, may require more extensive Interconnection Facilities, and will be addressed on a case by case basis. This is most likely to be required when several Customers desire to connect Electric Generators to the same transformer or on the same distribution feeder.

As specified in FERC Order 2006 10 kw and less UL1741 Listed Pre Certified - Inverter based units order will be accepted. Customers should supply that information as part of the application.

**1.2 Scope**

Distribution generation installed within Company’s service area will fall into one of seven scenarios:

Case 1.	<p>The Customer may build facilities that are NEVER connected to the Entergy distribution system some examples are:</p> <ul style="list-style-type: none"> <li>• An emergency generator. Where electric cords are run directly to this generator for essential lights and appliances.</li> <li>• A house with a switch, rated for the customers generator size that does not allow electricity to flow from the generator into the facility when the facility is connected to the grid.</li> </ul>
---------	--

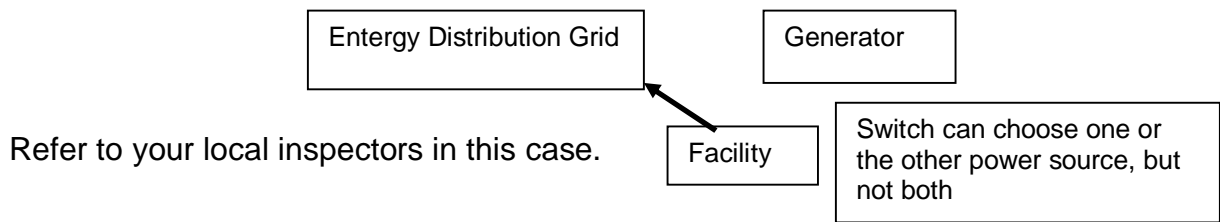

Case 2.	<p>The Customer may build facilities that are connected to their building or internal electrical system and are not intended to be connected to the distribution system. The Customer shall supply a open and visible break verifiable by Company personnel. The location shall be on the outside of the facility accessible to Company personnel at all hours. A main disconnect in the off position qualifies as an open break. It is recommended that the customer tag the disconnect to help prevent accidental closing.  <b>Failure to have a visible break is reason for being disconnected,</b> and subjects Customer to liability for resulting injury to people or property.</p>
Case 3.	<p>The Customer may build facilities that are NOT NORMALLY connected to the distribution system. Total connection time is 10 CYCLES OR LESS (@60 cycles/second). All loads become displaced. Stand-by facilities may or may not be requested. No energy is sold or sent to the Company. This Case is covered in <i>Connecting Large Electric Generators to the Entergy Distribution System (300kVA to 20MVA)</i></p>
Case 4.	<p>The Customer may build facilities that are connected to the distribution system more than 10 cycles (may be hours, days, months, etc.). Some or the entire load becomes displaced. Stand-by facilities may or may not be requested. No energy is sold or sent to the Company.</p>

Case 5.	The Customer may build facilities that are normally connected to the distribution system. Some or the entire load becomes displaced. Stand-by facilities are requested. A contract is signed for selling energy to the Company. The Company is required to buy electricity from FERC Qualified facilities This Case includes Net Metering Customers. Consult the Company.
Case 6	The Customer may build facilities that are normally connected to the distribution system. The Customer has no on-site load. A contract is signed for selling energy output to the Company. The Company is required to buy electricity from FERC Qualified facilities. Consult the Company.
Case 7.	The Customer may build facilities that are normally connected to the distribution system. A contract is signed with the Company for wheeling or wholesaling all energy output. This Case is covered in <i>Connecting Large Electric Generators to the Entergy Distribution System (300kVA to 20MVA)</i> and Entergy Transmission Standard PM3901.

## 2 Definitions

Abnormal Operating Conditions – A situation in which the Company is operating the Distribution Delivery System in a manner inconsistent with normal configuration or under conditions that do not normally exist. Examples of abnormal operating conditions are times when the Company must switch distribution feeder circuits out of use for repairs and switch other alternate feeders into use to deliver energy to Customers.

Central Business District Grids, Spot Network Grids and Downtown Underground Radially Fed Installations (CBD) are typically located in downtown areas in New Orleans, Baton Rouge, Lake Charles, West Monroe, Beaumont, Jackson, Little Rock, Pine Bluff, and Hot Springs. The common CBD setup is to have two or more transformers, each connected to a separate feeder and paralleled on the low voltage side through network protectors associated with each transformer. These protectors are commonly configured so that a small amount of fault current (usually in the range of one Amp) will cause the protector to trip. Injecting electric power (with a generator) will have a negative effect on reliability. Also see Network Service

Company - Entergy operating subsidiaries within the United States boundaries.

Customer - Any entity interconnected to the Company's Distribution Delivery System who takes electric service under one of Company's rate schedules.

Displaced load - The Customer's entire electrical requirement or a portion of it that, except for the output of the Customer's Energy Facilities, would have been served by the Company.

Distribution Delivery System - The Company's wires, equipment, and facilities having a voltage of 34.5 kV or below to which the Customer's Facility is interconnected.

Interconnection - The physical connection of facilities to the Distribution Delivery System so that Parallel Operation can occur

Interconnection Agreement - The Standard Interconnection Agreement for Facilities. (Available on the internet. Go to [www.entergy.com](http://www.entergy.com), select your state or jurisdiction, select residential and select Net Metering or contact 1 800 ENTERGY.)

Interconnection Facilities - Facilities installed solely to interconnect the Customer's system with that of the Company to facilitate the exchange of power between the Customers's Energy Facilities and the Company's power system including, but not limited to, connection, transmission, distribution, engineering, transformation, switching, metering, and safety equipment. Interconnection Facilities shall include any additions and/or modifications to the Company's system deemed by the Company to be necessary.

Network Service - Two or more primary distribution feeder sources electrically connected on the secondary (or low voltage) side to form one power source for one or more Customers. This configuration is designed to maintain service to the Customers even after the loss of one of these primary distribution feeder sources. Also see Central Business District Grids.

Net metering is an electricity policy for consumers who own (generally small) renewable energy facilities, such as wind, solar power or home fuel cells. "Net", in this context, is used in the sense of meaning "what remains after deductions" — in this case, the deduction of any energy outflows from metered energy inflows. Under net metering, a system owner receives retail credit for the electricity they generate using electricity meters accurately recording electric flow in both directions. Consult the Entergy webpage of your franchise or the appropriate Public utility for details.

Small Interconnected Electric Generators Customer's Facility - Hardware and software installed to measure the energy flow both into and out of the Customer's facilities for the purpose of determining the usage for billing, if any.

Parallel Operation - The operation of Energy Facilities by a Customer physically and electrically interconnected to the Company's Distribution Delivery System.

Point of Common Coupling (PCC) - The point where transfer of any electric power between the Customer's facilities and the Company's Distribution Delivery System takes place, normally at the point of attachment.

Protective Function - Unsafe Operating Conditions shall be prevented from occurring before, during, and after the Interconnection of a Customer Electric Generator System with the Distribution Delivery System. This system typically uses hardware (including switching devices), relay protection schemes and software that and shall be designed to isolate the Customer's System or to disconnect it from the Distribution Delivery System under Unsafe Operating Conditions or outages.

Quality of Service - An operating state of the Distribution Delivery System that provides usable power to a Customer. This state of usable power includes the parameters specified for power factor, voltage surges and sags, voltage flicker, frequency and harmonics. For more information on these parameters, refer to the first page of this standard for these sections.

Renewable Electric Generator System - A system of hardware and software by which electric energy is generated using sun, wind, water, or biomass products as the source and as allowed to be interconnected to the Company's Distribution Delivery System.

Stabilized - The Distribution Delivery System is considered stabilized when, following a disturbance, the system returns to the normal range of voltage and frequency for duration of five minutes.

Standard of Care - A term defining the level of awareness to maintain workplace and public safety in the design, installation and operation of facilities which generate power.

System Protection Facilities - The equipment required to protect the Company's system and its other Customers' facilities from Unsafe Operating Conditions occurring at the Customer's Energy Facilities. The protection requirements shall be met at the Point of Common Coupling (PCC), although the devices and functions providing the Protective Functions can be located elsewhere.

Unsafe Operating Conditions - A situation that if left uncorrected would result in: (1) harm to any personnel or damage to any equipment, (2) unacceptable system stability or, (3) operation outside established parameters affecting the Quality of Service to other Customers connected to the Distribution Delivery System.

### 3 Details

#### 3.1 Available Voltage Systems

The Company's primary Distribution Delivery Systems available for parallel generation operations are of grounded wye. Generally, all voltage levels from 120/240 V to 34.5 kV single-phase or three-phase (except delta, open-wye and Central Business District Grids) are available for Interconnection. Delta and open-wye secondary voltage configurations require special evaluation prior to Interconnection. The voltage level available for connecting the Customer Electric Generator System in parallel with the system depends on the desired location on the Company's Distribution Delivery System and the size of the Customer's Electrical Generator Facility. **Interconnected Electric Generators in Central Business District Grids is discussed in Section 3.8.11**

#### 3.2 Manually Operated Load Break Switch /Labeling/ Reasons for Disconnect from the Distribution Delivery System

##### 3.2.1 Manually Operated Load Break Switch

One visible blade opening, lockable, inspect-able disconnect for all the Net Metering generation within sight of service entrance meter preferably adjacent to meter, but within 10 feet of meter which is accessible to and lockable by Company personnel at all hours without notice shall be furnished by the Customer to the Company's specifications. (A pull-out type switch not accepted)

Company will accept one breaker (per customer) in lieu of blade opening type disconnect for non-battery backup solar units 25kVA and below. This breaker could be in a house panel/breaker box which is accessible to Company personnel at all hours without notice, and shall meet all of the other conditions of this section.

##### 3.2.2 Labels

Customer shall label

- Meter (or Breaker box if it is within one foot of meter) with type and size of generator with arrow pointing to it stating distance to disconnect. (Example 2.5 kW Solar & batteries, 3 ft → or 2.5 kW Solar & batteries, inside [when using breaker box only])
- If using breaker – The outside of the breaker box (that is more than one foot from meter) shall be labeled (example Solar Disconnect inside) and the breaker shall be labeled with arrow (Example solar disconnect ⇒)
- If using blade opening type disconnect – it shall be labeled with type of generator (Example Solar disconnect or wind power disconnect)

Label shall be red background with white letters and UV resistant. The lettering on each label/tag shall be 3/16 inch or larger and be either raised or incised on



each tag. Each tag shall be riveted or glued to the meter loop or switch or disconnect. Permanently attached tags are required.

The customer shall get **written approval of any and all variances** preferably in the design and planning stage. Contact the local Entergy Representative (or call 1-800-ENTERGY to get a representative assigned)

### **3.2.3 Reasons for Disconnect from the Distribution Delivery System**

The Company reserves the right, but has no responsibility either actual or implied, to open the disconnect switch without prior notice to the Customer for any of the following reasons:

- A. Distribution system emergency,
- B. Routine maintenance, repairs, and modifications,
- C. Elimination of a safety hazard, protection of the public or on-site personnel, or if instructed to do so by public safety personnel (law enforcement, fire department or other governmental personnel),
- D. Inspection of Customer's generating equipment and protective equipment reveals a hazardous condition, a lack of scheduled maintenance or maintenance records,
- E. The operation of the Customer's generating equipment results in a deteriorated quality of service or safety issue with other Customers or with the operation of the Company's system, or

The Company may disconnect a distributed generation unit from the distribution system under the following conditions:

- F. Expiration or termination of interconnection agreement
- G. Non-compliance with the technical requirements
- H. Lack of approved application and interconnection agreement
- I. Unauthorized modifications to the Customer's interface equipment

When possible, the Company shall provide the Customer with reasonable notice and reconnect the Customer as quickly as reasonably practical.

### **3.3 Electrical Current and Voltage of Existing Service**

The Company shall ascertain if the proposed generator output exceeds the current carrying capability and matches the voltage of the existing secondary service wires and transformers. If the Customer supplies his own transformation it should be configured for the Customer to monitor the Company's distribution system and react based upon specifications in this Standard. Grounded Wye to Grounded Wye transformers are preferred and Company approval is required before connection.

**The Company will advise Customer of any Customer costs which may be incurred if upgrades are required and the voltage, load carrying ability or transformation of the existing service.**

### **3.4 System Changes**

#### **3.4.1 Company Changes to Distribution Delivery System**

The Distribution Delivery System is a dynamic and changing system. If the Company changes the distribution voltage, the Customer will be responsible for paying for all modifications to the Customer's facilities required for reconnecting to the Company's reconfigured Distribution Delivery System. The Company will notify the Customer of reconfiguration programs.

#### **3.4.2 Customer Changes to Interconnection**

The Customer shall notify the Company to obtain prior approval for any proposed modifications to the interconnecting scheme.

### **3.5 Allowable Tie Points**

Normally, only one tie point between the Customer's facilities and the Company's Distribution Delivery System will be allowed.

### **3.6 Energy Flow during Emergencies**

Power flow from or to a Customer's facilities during periods of system emergencies may be discontinued. The Company shall pay for kWh actually received, not for Customer potential capacity.

### **3.7 Types of Allowed Generators**

Single- or three-phase alternating current generating units may be operated in parallel with the Distribution Delivery System. They may be synchronous generators, induction generators, or inverter-controlled systems. Direct-current generation shall not be directly connected to the Company's alternating-current Distribution Delivery System.

### **3.8 General Interconnection Requirements**

The Customer's Electrical Generation Facilities shall meet the technical requirements as prescribed in this section, in IEEE 1547 and IEEE 1547.1 latest version and in Section 4.0 References.

#### **3.8.1 Customer's Equipment and Interconnection Standards**

The Customer's Electrical Generation Facilities and Interconnection installation must meet all applicable national, state, and local construction and safety codes. The Customer shall be responsible for the design, installation, operation and maintenance of all equipment and facilities installed or that will be installed on the Customer's side of the Point of Common Coupling. Such design shall meet the latest standards of Institute of Electrical and Electronic Engineers, National Electric Manufacturers Association, American National Standards Institute, National Electric Code, other national codes and local codes pertaining to the design and construction of electrical facilities in effect at the time of installation.

The facility shall be subject to the requirements of all authorities having jurisdiction and shall comply with all applicable codes and ordinances.

### **3.8.2 Rating of Customer's Equipment**

The equipment selected by the Customer shall be rated for continuous Parallel Operation with the Company's system.

Customer's Electrical Generation Systems that are intended to provide the Customer with power during periods when the Company's facilities are unavailable shall be equipped with a transfer switch to prevent energizing a non-energized Company circuit consistent with sections 3.2, 3.13.3 and 3.8.1 of this policy.

### **3.8.3 Protection of Customer's Equipment**

The Customer will be responsible for protecting its facilities in such a manner that Distribution Delivery System outages, short circuits or other disturbances, including zero sequence currents and Ferro resonant over-voltages, do not damage the Customer's facilities.

The Customer's protective equipment shall be installed to prevent the Customer Electric Generator System from causing unnecessary tripping of the Distribution Delivery System breakers that would affect the Distribution Delivery System's ability to provide reliable service to other Customers.

Faults, single-phasing events, or other Abnormal Operating Conditions occurring on the Company's transmission system could affect a Customer's facilities connected to the Company's Distribution Delivery System. It is the Customer's responsibility to protect the Customer's facilities from these conditions.

### **3.8.4 Required Drawings**

Adequate drawings of the Customer's proposed Electric Generator System, which will include a one line diagram and proposed relay systems, must be submitted to the Company for review during the planning stage. Additional drawings may be required on a case by case basis.

### **3.8.5 Changes to Company Facilities**

The total cost of any additional equipment that must be installed by the Company on its Distribution Delivery System to allow Parallel Operation must be paid for by the Small Interconnected Electric Generators Customer, including the transformers and any facilities which must be added due to increased fault current or special operating conditions.

**3.8.6 Power Factor**

The power factor of the Customer Electric Generator System at the Point of Common Coupling shall be according to the appropriate rate schedule for this installation. The presence of the Customer Electric Generator System shall not cause the power factor to be lower than it was prior to installation and operation of the Customer Electric Generator System.

**3.8.7 Reactive Power Requirements**

The Customer's Electric Generator System shall normally be responsible for supplying the facility's own reactive power as required by the load to which it supplies power.

**3.8.8 Voltage Surges or Sags**

The Customer will operate its Electric Generator System in such a manner that the voltage levels on the Distribution Delivery System are in the same range (+5% or -5% from nominal voltage) as if the facilities were not connected to the Company's system. The Customer shall be responsible for any damages to the Customer's facilities, and shall be liable for any damages to the Company's facilities or the facilities of other Customers due to any under voltage or over voltage contribution from the Customer.

The Customer shall provide an automatic method of disconnecting the generating equipment from the distribution delivery system if:

Voltage Range (% of base voltage)	Time from beginning of event (seconds)
Less than 50%	0.16
50 to 89%	2.00
110% to 120%	1.00
Greater than 120%	0.16

**3.8.9 Voltage Flicker, Harmonic Distortion, Transients and other Power Quality Issues**

The Customer shall not create objectionable flicker, Harmonic Distortion, Transients, etc. for the Company's other Customers. Also consult Entergy's Power Quality Standards for Electric Service, latest edition which is available on The Entergy web site at [www.entergy.com](http://www.entergy.com). Go to your state, "Your Business", Builder Standards.

**3.8.10 Frequency**

When the operating frequency of the Customer's generating equipment deviates from the 60 Hz base. The Customer shall automatically disconnect the generating equipment from the distribution delivery system based upon the table below:

**Interconnection System Response to Abnormal Frequencies**

Generator size	Frequency range (Hz)	Time from beginning of event (seconds)
Less than or equal to 30kW	Greater than 60.5	0.16
	Less than 59.3	0.16
Greater than 30 kW	Greater than 60.5	0.16
	Less than 59.8 to 57	Adjustable 0.16 to 300 (consult Company)
	Less than 57	0.16

The Company may require the Customer to wait up to five minutes to reconnect after the distribution delivery system voltage and frequency return to normal range and the system is stabilized. Consult the Company for details. (IEEE 1547 4.2.6)

**3.8.11 Interconnected Electric Generators in Central Business District Grids**

The Company will not allow interconnection in Central Business District Underground Secondary Networks, Spot Network Grids and Downtown Underground Radially Fed Installations. In Central Business District Grids, Spot Networks, and Downtown Underground Radially Fed Installations a generator will have a negative effect on reliability and the safety of employees that maintain these systems. This policy will affect Spot Networks, CBD Grids and Downtown Underground Radially Fed Installations including those in New Orleans, Baton Rouge, Lake Charles, West Monroe, Beaumont, Jackson, Little Rock, Pine Bluff, and Hot Springs

**3.9 Inspection Prior to Operations and Additional Requirements**

The Company reserves the right to impose any herein described but unmet requirements and to make subsequent final inspection before the Customer Electric Generator System operates to verify that all such unmet requirements have been satisfied. However, the Company has no actual or implied responsibility in this regard. The Customer shall be responsible for making necessary changes, at the Customer's expense; to the facility should such changes be required.

Inspection by the Company of the Customer's equipment and Interconnection Facilities shall not constitute a determination by the Company of the continuing suitability of such equipment and Interconnection. An inspection by the Company shall in no way constitute a warranty or representation by the Company against future negligence, misuse, faulty repairs, or subsequently

developing defects, and the Company assumes no responsibility or liability therefore.

### **3.10 Responsibility for Customer's Operations**

The Company is not responsible for proper operations of the Customer's Electric Generator System upon and after Interconnection to the Company's Distribution Delivery System.

### **3.11 Responsibility for Customer's Annual Maintenance**

Annual maintenance of the Customer's facility is the Customer's sole responsibility. The Customer shall maintain records of such maintenance activities, which the Company may review at reasonable times. Such maintenance records shall be made available for the Company's inspection upon request. The Company reserves the right to inspect the records, but has no responsibilities for maintenance either actual or implied.

### **3.12 Protection/Interface Requirements**

Protecting both the Small Interconnected Electric Generators Customer's facilities and the Company's system are of great importance. Proper protective systems shall be established in the design phase and confirmed prior to start-up of the Customer's Electrical Generation Facility. An Interconnection between the Company and the Customer will not be allowed prior to the proper coordination of protective devices. The Customer shall be responsible for providing to the Company the necessary documentation certifying that maintenance and testing have been satisfactorily performed.

#### **3.12.1 Changes to Company Fault Interruption Equipment**

Customer Energy Facilities that are installed on the Company's Distribution Delivery System will provide additional fault current to the Distribution Delivery System. Thus, in special circumstances it is possible that the added facilities will necessitate the modification of the existing fault interrupting devices on the distribution feeder. The Customer will be responsible for paying the cost of these changes to the Company's system.

It is also possible that the added facilities will increase the available fault current on the Distribution Delivery System beyond the interrupting capability of the existing devices on the Distribution Delivery System. The Customer may be required to limit the fault current contribution from the Customer Electric Generator System. Should the Company also be required to make changes, the Customer shall pay the cost of the required changes. The issues will be examined on a case-by-case basis.

### **3.12.2 Tests of the Customer's Equipment**

The Company reserves the right, but has no responsibility either actual or implied, to observe the Customer's tests and/or inspection of any of the Customer's protective equipment that is essential to the Interconnection, including relays, circuit breakers, protective devices and related equipment. Inspection may include simulated test tripping of the Customer's Interconnection breakers by the protective relays to verify all protective set points and relay/breaker trip timing prior to Interconnection to the Company system.

Inspection by the Company of the Customer's equipment and Interconnection Facilities shall not constitute a determination by the Company of the continuing suitability of such equipment and Interconnection. An inspection by the Company shall in no way constitute a warranty or representation by the Company against future negligence, misuse, faulty repairs, or subsequently developing defects, and the Company assumes no responsibility or liability therefore.

The Customer shall provide the Company with notice at least two weeks before the initial energizing and start-up testing of the Customer's facilities so that the Company may witness the testing of any equipment and protective systems associated with the Interconnection.

If upon connecting to the Company's system a system emergency develops, safety issues arise, or the Quality of Service to other Customers is affected, the Company may then require additional inspections or tests of the Customer's protective equipment as per IEEE 1547 latest version.

### **3.12.3 Requirements for Specific Technologies**

Various technologies require unique control, protection, and safety equipment to be installed. The specifications in this section list those requirements unique to the technologies.

#### **3.12.3.1 Synchronous Generators**

For a Customer's synchronous generator, circuit breakers shall be three-phase devices with electronic or electro-mechanical control. The Customer is solely responsible for properly synchronizing its generator with the Company's Distribution Delivery System. The excitation system response ratio shall be 0.5 or greater. The generator's excitation system(s) shall conform, as near as reasonably achievable, to the field voltage versus time criteria specified in American National Standards Institute Standard C50.13-1989 in order to permit adequate field forcing during transient conditions.

### **3.12.3.2 Induction Generators and Inverter Systems**

Induction generation may be connected and brought up to synchronous speed (as an induction motor) if it can be demonstrated that the initial voltage drop measured on the Distribution Delivery System side of the Point of Common Coupling is within the allowable visible flicker standard - see §3.8.9. Otherwise, the Customer may be required to install hardware or employ other techniques to bring voltage fluctuations to acceptable levels.

Self-commutated inverters whether of the utility-interactive type or stand-alone type shall be used in parallel with the Distribution Delivery System only with synchronizing equipment.

Line-commutated inverters do not require synchronizing equipment. When a line commutated inverter system is used, no other fault-interrupting device is required. The inverter interrupts the fault.

### **3.13 Synchronizing Requirements**

The Customer shall be solely responsible for synchronizing and properly connecting and disconnecting its electrical system relative to Parallel Operation with the Company's system. The Customer shall provide an automatic synchronizing scheme to prevent the closing of its circuit breaker when the two electrical systems are out of synchronism. Also see Section 3.8.10.

### **3.14 Metering Requirements**

Based on the applicable rate schedule and the Company's standard practices, the Customer will provide the meter socket. The Company will supply the special meter that will measure the Customer's energy flow.

The Customer will be required to provide the Company with information regarding the total connected load. The Customer may be required to provide and / or install the meter socket, metering transformer enclosure, and adequate attachments or devices for attaching Company's metering facilities to the building. For additional information see the Company's *Customer Installation Standards for Electric Service* which is available on The Entergy web site at [www.entergy.com](http://www.entergy.com). Go to your state, "Your Business", Builder Standards.



#### **4 References**

*IEEE Guide for Protective Relaying of Utility-Consumer Interconnection C37.95  
(Latest revision)*

*IEEE Recommended Practices and Requirements for Harmonic Control in  
Electric Power Systems, 519-1992*

*IEEE Recommended Practice for Electric Power Distribution for Industrial Plants,  
141-1993*

*IEEE Standard for Interconnecting Distributed Resources with Electric Power  
Systems 1547*

*IEEE Standard Conformance for Test Procedures for Interconnecting Distributed  
Resources with Electric Power Systems 1547.1*

*American National Standards Institute Standard C50.13-1989*

*UL 1741 Inverters, Converters, Controllers and Interconnection System  
Equipment for Use with Distributed Energy Resources*

*Jurisdictional Rules and Rates for Arkansas, Louisiana, New Orleans and Texas*

*Entergy Customer Installation Standards for Electric Service, latest edition*

*Entergy Power Quality Standards for Electric Service, latest edition*

*Connecting Large Electric Generators to the Entergy Distribution System  
(300kVA to 20MVA) Entergy Standard DR701*

## 5 FLOW CHARTS (One Line Diagrams)

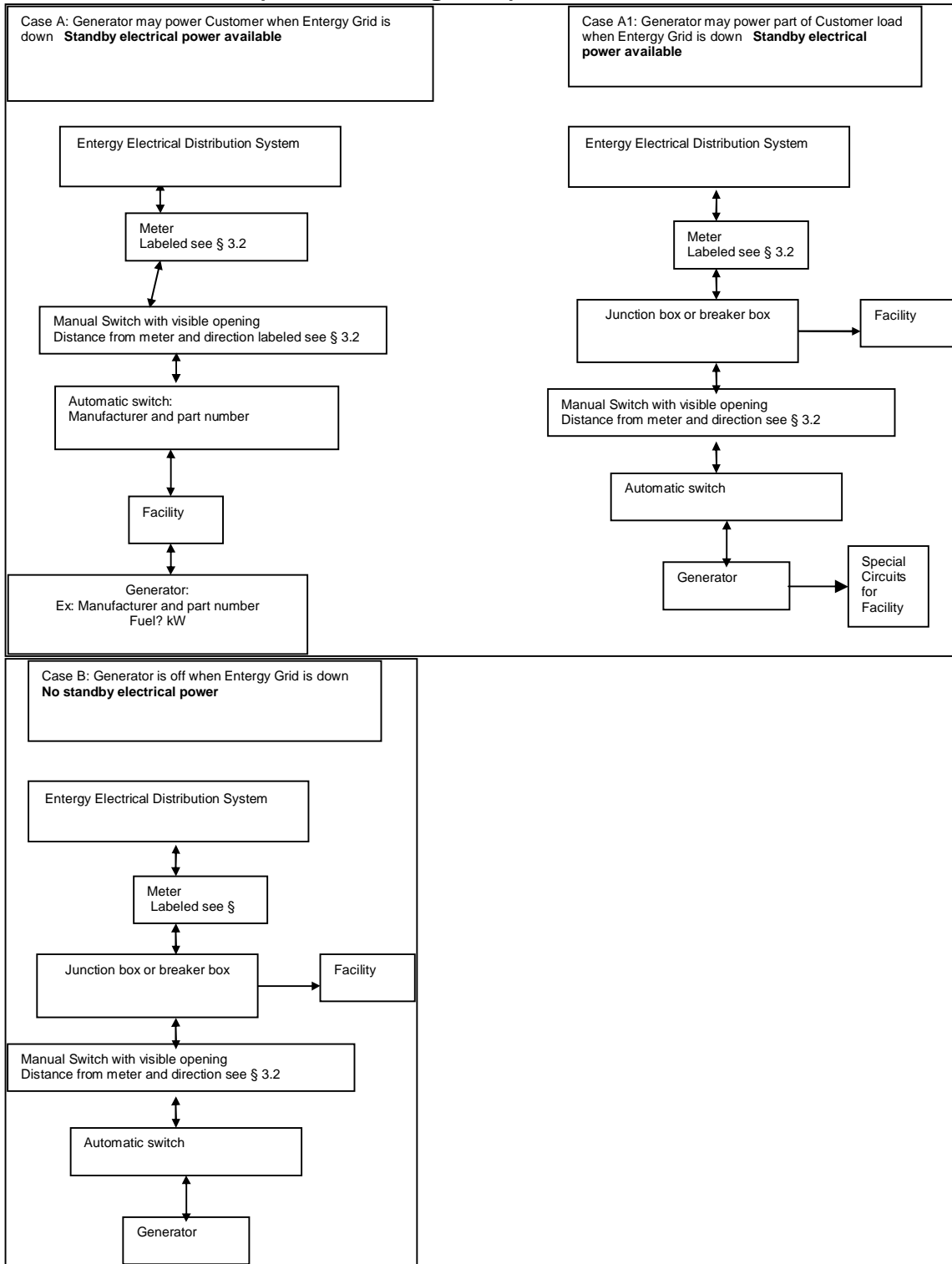

**Entergy Distribution Design Basis /Standards**

**Title: Connecting Small Electric Generators to the Entergy Distribution System (less than 300kVA)**

Effective Date:  
**May 04, 2016**

Note: A one line diagram submitted to the Company could be like the ones above with equipment specific information included

**6 Revisions**

06	<ul style="list-style-type: none"> <li>• Title of Standard changed from <i>Net Metering Facilities Safety and Performance Standards</i> to <i>Connecting Small Electric Generators to the Entergy Distribution System (less than 500kVA)</i> and expanded to include all interconnected generators below 500kVA.</li> <li>• Application moved to end of Standard</li> <li>• Added questions on application to learn if generator is to be connected less than 10 cycles.</li> <li>• Move Manually Operated Load Break Switch requirements from §3.8.1 and merge into §3.2 Reasons for Disconnection from the Distribution Delivery System</li> <li>• 3.14 Susceptibility to Transmission Faults moved to 3.8.3 Protection of Customer's Equipment</li> <li>• 3.8.11 sentence "Interconnections for Electric Generators will be allowed in Central Business Districts in overhead or standard underground distribution circuits which can comply with Company's Standards." Removed either the unit is in a legal downtown network grid or not</li> <li>• References to §3.2 added to 5.0 Flow Charts</li> </ul>	11/11/08
07	<ul style="list-style-type: none"> <li>• 3.2 The customer shall get written approval of any and all variances, preferably in the design and planning stage. Contact the local Entergy Representative (or call 1-800-ENTERGY to get a representative assigned).</li> <li>• In Application, short circuit rating of entire system only needed.</li> </ul>	10/15/09
08	<ul style="list-style-type: none"> <li>• Customer referred to website or 1 800 ENTERGY for application and Standards Interconnection Agreement form</li> <li>• Add to 3.2 .(A pull-out type switch not accepted unless it was installed, in place or approved before 1/26/2011)</li> </ul>	1/26/11
09	<ul style="list-style-type: none"> <li>• 3.2 Only one disconnect allowed for all Net metering generation at site. (submitted for clarity it was always one) per IEEE1547-2003 § 4.1.7</li> <li>• Disconnect must be within 10 feet of meter</li> </ul>	7/ 22/11

10	<p>Section 1.2 Scope</p> <p>Case 2. Has been changed to: “The Customer may build facilities that are connected to their building or internal electrical system and are not intended to be connected to the distribution system. The Customer shall supply a open and visible break verifiable by Company personnel. The location shall be on the outside of the facility accessible to Company personnel at all hours. A main disconnect in the off position qualifies as an open break. It is recommended that the customer tag the disconnect to help prevent accidental closing.</p> <p>Failure to have a visible break is reason for being disconnected, and subjects Customer to liability for resulting injury to people or property.”</p> <p>3.2 Manually Operated Load Break Switch / Reasons for Disconnect from the Distribution Delivery System  <b>Company will accept a breaker in lieu of blade opening type disconnect for non-battery backup solar units 25kVA and below. This breaker could be in a house panel/breaker box which is accessible to Company personnel at all hours without notice, and shall meet all of the other conditions of this section.</b></p>	4/17/2012
11	<p>Modified requirements for labels</p> <p>3.2.2 Labels Customer shall label</p> <ul style="list-style-type: none"> <li>• Meter (or Breaker box if it is within one foot of meter) with type and size of generator with arrow pointing to it stating distance to disconnect. (Example 2.5 kW Solar &amp; batteries, 3 ft → or 2.5 kW Solar &amp; batteries, inside [when using breaker box only])</li> <li>• If using breaker – The outside of the breaker box (that is more than one foot from meter) shall be labeled (example Solar Disconnect inside) and the breaker shall be labeled with arrow (Example solar disconnect ⇒)</li> <li>• If using blade opening type disconnect – it shall be labeled with type of generator (Example Solar disconnect or wind power disconnect)</li> </ul> <p>Label shall be red background with white letters and UV resistant. The lettering on each label/tag shall be 3/16 inch or larger and be either raised or incised on each tag. Each tag shall be riveted or glued to the meter loop or switch or disconnect. Permanently attached tags are required.</p>	3/12/12
Rev 12	Classified as Manual & reviewed/ reorganized for easier reading	4/30/12

**Entergy Distribution Design Basis /Standards**

Title: **Connecting Small Electric Generators to the Entergy Distribution System(less than 300kVA)**

Effective Date:

**May 04, 2016**

Rev 13	Changed Connecting Large Electric Generators to the Entergy Distribution System lower range from 500 kVA to 300 kVA to align with the less than 300kVA limit for Net Metering Inquiry and Application Processes Standard due to minimum impact on the Distribution System.	5/04/16
--------	--	---------

**Exhibit H-2**

**Connecting Large Electric Generators to the Entergy Distribution System  
(300kVA to 20MVA)**



<b>Title: Connecting Large Electric Generators to the Entergy Distribution System (300kVA to 20MVA)</b>	<b>Effective Date: May 04, 2016</b>
Prepared By: Michael R. Gray Distribution Design Basis / Standards	Approved By: James R. Hickman Manager of Distribution Design Basis / Standards

## Table of Contents

1	INTRODUCTION .....	3
1.1	PURPOSE.....	3
1.1.1	<i>Operating Agreement Requirements</i> .....	4
1.1.2	<i>Explicit Criteria for Parallel Operations</i> .....	4
1.2	SCOPE .....	5
2	DEFINITIONS.....	6
3	DETAILS .....	10
3.1	AVAILABLE VOLTAGE SYSTEMS .....	10
3.2	MANUALLY OPERATED LOAD BREAK SWITCH / REASONS FOR DISCONNECT FROM THE DISTRIBUTION DELIVERY SYSTEM .....	10
3.3	PRE-INTERCONNECTION STUDIES FOR INTERCONNECTION OF DISTRIBUTED GENERATION. ....	11
3.4	SYSTEM CHANGES.....	11
3.4.1	<i>Company Changes to Distribution System</i> .....	11
3.4.2	<i>Customer Changes to Interconnection</i> .....	12
3.5	ALLOWABLE TIE POINTS .....	12
3.6	ENERGY FLOW DURING EMERGENCIES.....	12
3.7	TYPES OF ALLOWED GENERATORS.....	12
3.7.1	<i>Limits on Three Phase Generators</i> .....	12
3.7.2	<i>Limits on Single Phase Generators</i> .....	12
3.8	GENERAL INTERCONNECTION REQUIREMENTS .....	12
3.8.1	<i>Customer's Equipment and Interconnection Standards</i> .....	12
3.8.2	<i>Rating of Customer's Equipment</i> .....	13
3.8.3	<i>Protection of Customer's Equipment</i> .....	14
3.8.4	<i>Required Drawings</i> .....	14
3.8.5	<i>Changes to Company Facilities</i> .....	14
3.8.6	<i>Communications Facilities</i> .....	14
3.8.7	<i>Power Factor</i> .....	14
3.8.8	<i>Reactive Power Requirements</i> .....	14
3.8.9	<i>Voltage Surges or Sags</i> .....	15
3.8.10	<i>Voltage Flicker, Harmonic Distortion, Transients and other Power Quality Issues</i> .....	15
3.8.11	<i>Frequency</i> .....	15
3.8.12	<i>Reconnection to distribution delivery system</i> .....	15
3.8.13	<i>Central Business District Network</i> .....	16
3.9	INSPECTION PRIOR TO OPERATIONS AND ADDITIONAL REQUIREMENTS.....	16
3.10	RESPONSIBILITY FOR CUSTOMER'S OPERATIONS .....	16
3.11	RESPONSIBILITY FOR CUSTOMER'S MAINTENANCE.....	16
3.12	LOAD SHED RESPONSIBILITIES.....	16
3.13	PROTECTION/INTERFACE REQUIREMENTS.....	17

This document is the property of Entergy Services, Inc. and contains confidential and proprietary information owned by Entergy Services, Inc. Any copying, use, or disclosure of this information without the written permission of Entergy Services, Inc. is strictly prohibited. This material is protected under trade secret and unfair competition laws and the expression of the information contained herein is protected under Federal copyright laws. Violations thereof may result in criminal penalties and fines.





<b>Title: Connecting Large Electric Generators to the Entergy Distribution System (300kVA to 20MVA)</b>	<b>Effective Date: May 04, 2016</b>
Prepared By Michael R Gray Distribution Design Basis / Standards	Approved By: James R. Hickman Manager of Distribution Design Basis / Standards

- 3.13.1 *Changes to Company Fault Interruption Equipment*..... 17
- 3.13.2 *Tests of the Customer's Equipment* ..... 17
- 3.13.3 *Specifying Protective Equipment*..... 17
- 3.13.4 *Service Interruption Equipment*..... 18
- 3.13.5 *Exception to Automatic Disconnect Equipment Requirements*..... 18
- 3.13.6 *Fault Interrupting Device* ..... 18
- 3.13.7 *Equipment to Block Energizing Dead Circuits*..... 18
- 3.14 CONTROL, PROTECTION AND SAFETY EQUIPMENT REQUIREMENTS FOR SPECIFIC TECHNOLOGIES ..... 18
  - 3.14.1 *Synchronous Generators*..... 18
  - 3.14.2 *Induction Generators and Inverter Systems*..... 19
- 3.15 SUSCEPTIBILITY TO TRANSMISSION FAULTS ..... 19
- 3.16 SYNCHRONIZING REQUIREMENTS..... 19
- 3.17 SUMMARY OF PROTECTIVE FUNCTION REQUIREMENTS..... 19
  - 3.17.1 *All Facilities*..... 19
  - 3.17.2 *Facilities Rated More than 2MVA*..... 20
  - 3.17.3 *Facilities Rated More than 10MVA*..... 20
- 3.18 METERING REQUIREMENTS..... 20
- 3.19 COMMUNICATION CRITERIA FOR REQUIRING TELEMETERING..... 20
- 3.20 TRANSFORMATION REQUIREMENTS..... 21
- 4 REFERENCES ..... 23
- 5 RESPONSIBILITIES ..... 23
  - 5.1 INTERPRETATION ..... 23
  - 5.2 DEVIATION..... 24
- 6 ATTACHMENTS - METERING ARRANGEMENTS..... 25
- 7 REVISIONS ..... 25
- 8 APPLICATION ..... 27
- 9 DISTRIBUTED GENERATION TECHNICAL REQUIREMENTS COMPLIANCE CHECKLIST ..... 30

Title: **Connecting Large Electric Generators to the Entergy Distribution System(300kVA to 20MVA)**

Effective Date:  
**May 04, 2016**

## 1 Introduction

### 1.1 Purpose

A Customer may operate 60 Hertz (Hz), three-phase or single-phase generating equipment in parallel with the distribution delivery system pursuant to an interconnection agreement, provided that the equipment meets or exceeds the Company standards. FERC Qualifying facilities or small power producers also have rates in each jurisdiction allowing them to sell power to the Company. Customers who do not meet the above conditions shall not inject Electric Power onto the Company Distribution System without agreement from the Company.

The purpose of this standard is to describe the requirements and procedures for safe and effective connection and operation of electric generators 300kVA to 20MVA on the Entergy Distribution electric system. Customers who are smaller than 300kVA (including QF-12 Mississippi Customers and Net Metering Customers) should refer to *Connecting Small Electric Generators to the Entergy Distribution System (less than 300kVA)*. Customers larger than 20 MVA or who would interconnect at Transmission level voltages (69kV and above) should contact Entergy Transmission. **Customers are encouraged to contact the Company early in the process, and learn about Customer requirement and specific requirements due to their location on the electric grid.** Customers may call 1 800 ENTERGY to get a local engineer assigned.

The **Distributed Generation Technical Requirements Compliance Checklist** at the end of this Standard is a summary of the requirements. The process of Connection is started by a Customer submitting a completed **Application** and a completed **Distributed Generation Technical Requirements Compliance Checklist** (both are at the end of this Standard).

This standard describes typical interconnection requirements. Certain specific interconnection locations and conditions may require more information from the Customer or the installation and use of more sophisticated protective devices and operating schemes, especially when the facility is exporting power through the distribution delivery system. **Interconnection in Central Business District Networks is discussed in Section 3.8.13.**

If the Company concludes that an Application to Connect Electric Generators to the Entergy Distribution System describes facilities that may require additional devices and operating schemes, the Company shall make those additional requirements known to the Customer at the time the interconnection studies are completed.

Title: **Connecting Large Electric Generators to the Entergy Distribution System(300kVA to 20MVA)**

Effective Date:  
**May 04, 2016**

### **1.1.1 Operating Agreement Requirements**

A written agreement will be required between the Company and the Customer outlining the liability provisions, indemnities, payment of cost to modify distribution system (if not paid in advance), and other items affecting service under this document. This agreement will explain in detail the authority or responsibilities of the parties involved. **An interconnection between the Company and a Customer will not be allowed prior to the execution of a written Operating Agreement covering parallel operation.**

### **1.1.2 Explicit Criteria for Parallel Operations**

Two objectives must be met to arrive at compliance by the proposed installation:

#### **1.1.2.1 Safety**

The Customer's Electric Generators will be held to the same Standard of Care, as the Company is required to maintain. In addition, the safety of the general public and the personnel and equipment of the Company shall in no way be reduced or impaired as a result of the Interconnection.

The Customer's Electrical Generator shall be equipped with Protective Functions designed to prevent the Generator from being connected to a de-energized circuit owned by the Company.

The Customer's Electrical Generation Facility shall be equipped with the necessary Protective Functions designed to prevent connection or Parallel Operation of the Customer's facility with the Distribution Delivery System unless the Distribution Delivery System service voltage and frequency are of normal magnitude. The design of some systems provides these functions without adding equipment at the Point of Common Coupling. Each system not providing additional devices at the Point of Common Coupling must be shown to be capable of these functions.

#### **1.1.2.2 Customer Impact**

The quality, reliability and the availability of service to the Company's other Customers shall not be diminished or impaired as a result of the Interconnection. This standard describes typical connection requirements. Some installations, however, may require more extensive Interconnection Facilities, and will be addressed on a case by case basis. This is most likely to be required when several Customers desire to connect Electric Generators to the same transformer or on the same distribution feeder.

Title: **Connecting Large Electric Generators to the Entergy Distribution System(300kVA to 20MVA)**

Effective Date:  
**May 04, 2016**

**1.2 Scope**

Distribution generation installed within Entergy’s service area will fall into one of seven scenarios:

Case 1.	The Customer may build facilities that are NEVER connected to the Entergy distribution system some examples are: An emergency generator. Where electric cords are run directly to this generator for essential lights and appliances. A house with a switch, rated for the customers generator size that does not allow electricity to flow from the generator into the facility when the facility is connected to the electric utility system.
---------	---

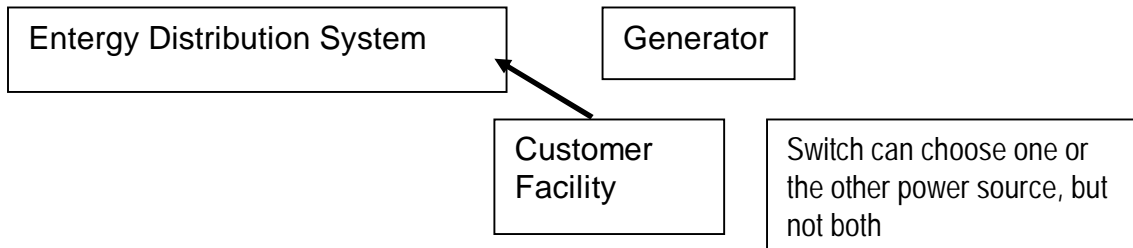

**Refer to your local inspectors in this case.**

Case 2.	The Customer may build facilities that are connected to their building or internal electrical system and are not intended to be connected to the distribution system. The Customer shall supply an open and visible break verifiable by Company personnel. The location shall be on the outside of the facility accessible to Company personnel at all hours. A main disconnect in the off position qualifies as an open break. It is recommended that the customer tag the disconnect to help prevent accidental closing. <b>Failure to have a visible break is reason for being disconnected,</b> and subjects Customer to liability for resulting injury to people or property.
Case 3.	The Customer may build facilities that are NOT NORMALLY connected to the distribution system. Total connection time is 10 CYCLES OR LESS (@60 cycles/second). All loads become displaced. Stand-by facilities may or may not be requested. No energy is sold or sent to the Company.
Case 4.	The Customer may build facilities that are connected to the distribution system more than 10 cycles (may be hours, days, months, etc.). Some or the entire load becomes displaced. Stand-by facilities may or may not be requested. No energy is sold or sent to the Company.
Case 5.	The Customer may build facilities that are normally connected to the distribution system. Some or the entire load becomes displaced. Stand-by facilities are requested. A contract is signed for selling energy to the Company.

List continued on next page

Title: **Connecting Large Electric Generators to the Entergy Distribution System(300kVA to 20MVA)**

Effective Date:  
**May 04, 2016**

Case 6	The Customer may build facilities that are normally connected to the distribution system. The Customer has no on-site load. A contract is signed for selling energy output to the Company.
Case 7.	The Customer may build facilities that are normally connected to the distribution system. A contract is signed with the Company for wheeling or wholesaling energy output. <b>Transmission Company involvement required.</b> Also see Section 3.17.2& 3.17.3

These provisions are the minimum requirements of non-Entergy Corporation distributed generation units for operation of the units in parallel with the Company's distribution system for voltages up to and including 34.5kV. (Refer to Entergy Transmission Standard PM3901, Generator Interconnection Customer Requirements Standard and Section 3.17.2 & 3.17.3 for provisions to connect to the Company's transmission system for voltages above 34.5kV.)

Generation systems of significant size on radial distribution systems can cause relaying and voltage control problems. The Company therefore retains the option to connect any generation facilities at either the transmission or the distribution voltage level.

## 2 Definitions

Abnormal operating conditions – When the Company is operating the distribution delivery system in other than normal configuration or under conditions that do not normally exist. Examples of abnormal operating conditions are: (1) high usage days when Customers are requested to conserve energy or, (2) switching feeders out of use for repairs and switching in alternate feeders to deliver energy to Customers.

Application to Connect Electric Generators to the Entergy Distribution System - The standard form of application attached the end to of this document.

Central Business District Networks, Spot Networks and Downtown Underground Radially Fed Installations (CBD) are typically located in downtown areas in New Orleans, Baton Rouge, Lake Charles, West Monroe, Beaumont, Jackson, Little Rock, Pine Bluff, and Hot Springs. The common CBD setup is to have two or more transformers, each connected to a separate feeder and paralleled on the low voltage side through network protectors associated with each transformer. These protectors are commonly configured so that a small amount of fault current (usually in the range of one Amp) will cause the protector to trip. Injecting electric power (with a generator) will have a negative effect on reliability. Also see Network Service

Company - Entergy operating subsidiaries within the United States boundaries.

Title: **Connecting Large Electric Generators to the Entergy Distribution System(300kVA to 20MVA)**

Effective Date:  
**May 04, 2016**

Customer - Any entity interconnected to the Company's distribution delivery system for the purpose of receiving or exporting electric power through the Company's distribution delivery system.

Displaced load - The Customer's entire electrical requirement or a portion of it that, except for the output of the Customer's Energy Facilities, would have been served by the Company.

Distributed generation (DG) – See On-site distributed generation.

Distribution delivery system – The Company's wires, equipment, and facilities with a voltage below 69kV to which the generation equipment is interconnected.

Facility - An electrical generating installation consisting of one or more on-site distributed generation units. The total capacity of a facility's individual on-site distributed generation units may exceed twenty megawatts (MW). Units greater than 2MW will require consultation with Transmission.

Interconnection - The physical connection of distributed generation to the distribution delivery system in accordance with the requirements of this standard so that parallel operation can occur.

Interconnection agreement – The document that sets forth the contractual conditions under which the Company and a Customer agree that one or more facilities may be interconnected with the Company's distribution delivery system.

Interconnection facilities - All facilities installed solely to interconnect and deliver/receive power from/to the Customer's generation facility to/from the Company's system including, but not limited to, connection, transmission, distribution, engineering, administration, transformation, switching, metering, and safety equipment. Interconnection Facilities shall include any additions and/or modifications to the Company's system deemed by the Company to be necessary.

Net Metering - To encourage Customers to generate electric power using solar, wind, hydropower, geothermal, or qualified biomass resources, these Customers may be entitled to sell electricity to their electric utility at more favorable rates. This varies by Jurisdiction. These Customers are all covered by **Connecting Small Electric Generators to the Entergy Distribution System (<300kVA)**

Network service - Two or more primary distribution feeder sources electrically tied together on the secondary (or low voltage) side to form one power source for one or more Customers. This configuration is designed to maintain service to the Customers even after the loss of one of these primary distribution feeder sources.

Title: **Connecting Large Electric Generators to the Entergy Distribution System(300kVA to 20MVA)**

Effective Date:  
**May 04, 2016**

On-site distributed generation (distributed generation or DG) - An electrical generating facility located at a Customer's point of delivery (point of common coupling) of twenty Mega Volt-Amps called "apparent power" (MVA) or less and connected at a voltage less than or equal to 35 kilovolts (kV) which may be connected in parallel operation to the distribution delivery system.

Parallel operation - The operation of on-site distributed generation by a Customer while the Customer's facilities are electrically connected to the Company's distribution delivery system.

Point of common coupling - The point where transfer of any electric power between the Customer's facilities and the distribution delivery system takes place, normally at the point of attachment.

Pre-interconnection study - A study or studies that may be undertaken by the Company in response to its receipt of a completed application for interconnection and parallel operation with the distribution delivery system. Pre-interconnection studies may include, but are not limited to:

Scoping meetings/Studies *includes*

A fact finding meeting/telecom with Customer and discussion of Customer responsibilities and requirements and applicable policies. (Customer Relations and Asset Planning)

Asset Planning to determine if interference with the system protective equipment may occur, electricity may flow back to the substation and impact transmission, available fault current, capacitor bank impact, frequency, and voltage may be effected under normal and worst case situations. Conductors / Lines or other devices and elements that may be undersized or otherwise need settings changes as a result of the proposed generation

Discussion/Meeting with Customer to either

If no impacts on Distribution or the Transmission grid are identified, accept the project and Customer Relations presents a contract, or Share potential impacts and future studies necessary, advise estimated costs of chosen study(s) and may provide order of magnitude estimates on facilities costs.

If transmission is to be involved to discuss this with Customer and get Transmission to contact Customer and discuss *Entergy Small Generator Interconnection Procedures* and other policies or procedures involved.

Product is the minimum information for attaching a small distributed generation unit at a particular location on the distribution system or results in identifying the necessity of further engineering studies or if transmission involvement is necessary.

Title: **Connecting Large Electric Generators to the Entergy Distribution System(300kVA to 20MVA)**

Effective Date:  
**May 04, 2016**

**Feasibility Study – A formal study identifying**

Any system protection equipment short circuit capacity limits exceeded,  
Thermal overload, frequency or voltage limit violations resulting from the interconnection,  
Initial review of grounding requirements and coordination.  
Transfer trip analysis,  
Product is initial and non-binding estimates of facilities, cost to interconnect and identification of further studies needed and their cost.  
Entergy requires a **\$1,000** deposit for the Feasibility Study. Study is done at Customer cost.

**System Impact Study – shall**

Identify and detail the electric system impacts that would result if the proposed Small Generating Facility were interconnected without project modifications or electric system modifications, focusing on the adverse system impacts identified in the feasibility study,  
Study potential impacts, including but not limited to those identified in the scoping meeting.  
Product is an evaluation of the impact of the proposed interconnection on the reliability of the electric system.  
Entergy requires a **\$50,000** deposit for the System Impact Study. Study is done at Customer cost.

**Facilities study –**

Shall specify and estimate the cost of the equipment, engineering, procurement and construction work (including overheads) needed to implement the conclusions of the system impact study(s).  
Entergy requires a deposit of the good faith estimated costs for the facilities study from the Customer. Study is done at Customer cost.

Protective function - A system that uses hardware (including switching devices), relay protection schemes and software that prevents unsafe operating conditions from occurring before, during, and after the interconnection of the generating unit with the distribution delivery system. This system will include isolating the Customer's Generation or decoupling it from the distribution delivery system.

Quality of service – An operating state of the distribution delivery system that provides usable power to a Customer. This state of usable power includes the parameters specified for voltage flicker (Section 3.8.10), voltage surges and sags (Section 3.8.9), power factor (Section 3.8.7 & 3.8.8), frequency (Section 3.8.11) and harmonics (Section 3.8.10).



Title: **Connecting Large Electric Generators to the Entergy Distribution System(300kVA to 20MVA)**

Effective Date:  
**May 04, 2016**

Stabilized - The distribution delivery system is considered stabilized when, following a disturbance, the system returns to the normal range of voltage and frequency for a duration of five minutes or a shorter time as mutually agreed to by the Company and Customer.

Standard of care - A term defining the level of awareness to maintain workplace and public safety in the design, installation and operation of a DG facility.

System protection facilities - The equipment required to protect the Company's system and its other Customers from unsafe operating conditions occurring at the Customer's generation facility. This includes inverter systems and any other devices provided with the on-site distributed generating unit for providing the system protection functions.

Unsafe operating conditions – A situation that if left uncorrected would result in: (1) harm to any personnel, damage to any equipment, (2) unacceptable system instability or, (3) operating outside legally established parameters affecting the quality of service to other Customers connected to the distribution delivery system.

### 3 Details

#### 3.1 Available Voltage Systems

The Company's distribution systems available for parallel generation operations are grounded wye configuration of various existing voltage levels from secondary voltage levels to 34.5kV (phase to phase). The voltage level available for connecting the DG in parallel with the system depends on the location and the size of the generation.

#### 3.2 Manually Operated Load Break Switch / Reasons for Disconnect from the Distribution Delivery System

The Customer's generation facilities shall have a lockable, manually operated, visible-break isolation load break switch that shall be in a location accessible to the Company's personnel at all hours with no notice. (Pull out type switches are not accepted) For a three phase generator, this disconnect must be a group operated device that through one operation will open/close all three phases simultaneously. Customer shall label meter can with type and size of generator with arrow pointing to it stating distance to disconnect. (Example 300kVA Gas engine generator, 3 ft.⇒) Permanently attached tags are required. The lettering on each tag shall be 3/16 inch or larger and be either raised or incised on each tag. Each tag shall be riveted or glued to the meter can. (If the circuit breaker is accessible to Company personnel, this requirement may be waived.) The Company reserves the right, but has no responsibility either actual or implied, to open the disconnect switch without prior notice to the Customer for any of the following reasons:

- A. Distribution system emergency,
- B. Routine maintenance, repairs, and modifications,

Title: **Connecting Large Electric Generators to the Entergy Distribution System(300kVA to 20MVA)**

Effective Date:  
**May 04, 2016**

- C. Elimination of a safety hazard, protection of the public or on-site personnel, or if instructed to do so by public safety personnel (law enforcement, fire department or other governmental personnel),
- D. Inspection of Customer's generating equipment and protective equipment reveals a hazardous condition, a lack of scheduled maintenance or maintenance records,
- E. The operation of the Customer's generating equipment results in a deteriorated quality of service or safety issue with other Customers or with the operation of the Company's system, or

The Company may disconnect a distributed generation unit from the distribution system under the following conditions:

- F. Expiration or termination of interconnection agreement
- G. Non-compliance with the technical requirements
- H. Lack of approved application and interconnection agreement
- I. Unauthorized modifications to the Customer's interface equipment

When possible, the Company shall provide the Customer with reasonable notice and reconnect the Customer as quickly as reasonably practical.

### **3.3 Pre-Interconnection Studies for Interconnection of Distributed Generation.**

The Company shall, at the Customer's expense, conduct one or more pre-interconnect studies prior to interconnection of a distributed generation facility.

Certain aspects of secondary network systems create technical difficulties that may make interconnection more costly to implement. In instances where Customers request interconnection to a secondary network system, the ability of the distributed generator owner to have access to the distribution delivery system and/or the transmission grid may be limited. The Company shall conduct pre-interconnection and network studies to determine to what amount additional distributed generation facilities can be safely added to the network or accommodated in some other fashion.

In Entergy Office of Records Series 1274– Planning Studies, the Company shall retain its documentation (of its evaluation of the reliability impact of the new facilities and their connections on the interconnected transmission systems) for three years and shall provide the documentation to the Regional Reliability Organization(s) and NERC on request (within 30 calendar days).

## **3.4 System Changes**

### **3.4.1 Company Changes to Distribution System**

The distribution system is a dynamic and changing system. If the Company changes the distribution voltage, the Customer will be responsible for paying for all modifications required for reconnecting to the Company's reconfigured distribution system.

Title: **Connecting Large Electric Generators to the Entergy Distribution System(300kVA to 20MVA)**

Effective Date:  
**May 04, 2016**

### **3.4.2 Customer Changes to Interconnection**

The Customer shall notify the Company to obtain prior approval for any proposed modifications to the interconnecting scheme.

### **3.5 Allowable Tie Points**

Normally, only one tie point between the Customer and the Company will be allowed at the Customer's site.

### **3.6 Energy Flow during Emergencies**

Purchases from or sales to a Customer during periods of system emergencies may be discontinued according to the regulatory body's rules, and the Company's rates, riders or contract with the Customer.

### **3.7 Types of Allowed Generators**

Single phase or three-phase alternating current generating units can be operated in parallel with the distribution system. They may be synchronous generators, induction generators, or inverter controlled systems. When the total connected capacity exceeds 10MW or when current will flow onto the Transmission grid application will be also sent to Transmission as per sections 3.17.2 & 3.17.3. Direct-current generation shall not be directly connected to the Company's alternating-current Distribution Delivery System.

#### **3.7.1 Limits on Three Phase Generators**

If three-phase service is not available in the area or if Company facilities must be upgraded or increased in order to enable the Customer to connect to these facilities, the Customer must bear the additional cost for such service or improvements as determined by the Company. The Company reserves the right to refuse three-phase service under certain circumstances.

#### **3.7.2 Limits on Single Phase Generators**

Where necessary to avoid the potential for a generating facility to cause problems with the service of other Customers, the Company may limit the capacity and operating characteristics of single-phase generators in a manner consistent with its existing limitations for single-phase motors and local line equipment and configuration.

### **3.8 General Interconnection Requirements**

The Customer's distributed generation facilities shall meet the technical requirements as prescribed in this section and in IEEE 1547 latest version.

#### **3.8.1 Customer's Equipment and Interconnection Standards**

The Customer's generation and interconnection installation must meet all applicable national, state, and local construction and safety codes.

The Customer shall be responsible for the design, installation, operation, testing and maintenance of all equipment and facilities installed or that will be installed on the

---

Title: **Connecting Large Electric Generators to the Entergy Distribution System(300kVA to 20MVA)**

---

Effective Date:  
**May 04, 2016**

---

Customer's side of the Point of Common Coupling. Such design shall meet the latest standards of IEEE, NEMA, ANSI, NEC, FERC other national codes and any local codes pertaining to the design and construction of electrical facilities. The facility shall be subject to the requirements of all authorities having jurisdiction and shall comply with all applicable codes and ordinances.

### **3.8.2 Rating of Customer's Equipment**

The equipment selected by the Customer shall be rated for continuous parallel operation with the Company's system.

Title: **Connecting Large Electric Generators to the Entergy Distribution System(300kVA to 20MVA)**

Effective Date:  
**May 04, 2016**

### **3.8.3 Protection of Customer's Equipment**

The Customer will be responsible for protecting its generating equipment in such a manner that distribution delivery system outages, short circuits or other disturbances including zero sequence currents and Ferro resonant over-voltages do not damage the Customer's generating equipment. The Customer's protective equipment shall also prevent unnecessary tripping of the distribution delivery system breakers that would affect the distribution delivery system's capability of providing reliable service to other Customers.

### **3.8.4 Required Drawings**

Adequate drawings of the proposed Customer's generation facility, which will include a one line diagram and proposed relay systems, must be submitted to the Company for review during the planning stage. Additional drawings may be required which will be determined on a case by case basis.

### **3.8.5 Changes to Company Facilities**

The total cost of any additional equipment that must be installed by the Company on its distribution system to allow parallel operation must be borne by the Customer, including the transformers and any facilities which must be added due to increased fault current or special operating conditions.

### **3.8.6 Communications Facilities**

For generating facilities greater than one megawatt (MW), the Company may require that a communication channel be supplied by the Customer to provide communication between the Company and the Customer's facility.

### **3.8.7 Power Factor**

The power factor of the Customer's generation facilities at the interconnection point with the Company shall be according to the appropriate rate schedule for this installation.

### **3.8.8 Reactive Power Requirements**

The Customer's generation facility shall normally be responsible for supplying its own reactive power as required by the load supplied from its own generation. Should the Customer be unable or unwilling to supply the reactive power, a separate rate schedule shall apply and the installation shall be metered for VAR flow.

Title: **Connecting Large Electric Generators to the Entergy Distribution System(300kVA to 20MVA)**

Effective Date:  
**May 04, 2016**

### 3.8.9 Voltage Surges or Sags

The Customer will operate its generating equipment in such a manner that the voltages levels on the distribution delivery system are in the same range as if the generating equipment were not connected to the Company's system. The Customer shall be liable for any damages done to their own facilities, the Company's facilities, or the facilities of other Customers due to any under voltage or over voltage contribution from the DG unit.

The Customer shall provide an automatic method of disconnecting the generating equipment from the distribution delivery system if:

Voltage Range (% of base voltage)	Time from beginning of event (seconds)
Less than 50%	0.16
50 to 89%	2.00
110% to 120%	1.00
Greater than 120%	0.16

### 3.8.10 Voltage Flicker, Harmonic Distortion, Transients and other Power Quality Issues

The Customer Energy Facility shall not create objectionable flicker, Harmonic Distortion, Transients, etc. for the Company's other Customers. Also consult Entergy's Power Quality Standards for Electric Service, latest edition which is available on The Entergy web site at [www.entergy.com](http://www.entergy.com). Go to your state, "Your Business", Builder Standards.

### 3.8.11 Frequency

When the operating frequency of the Customer's generating equipment deviates from the 60 Hz base. The Customer shall automatically disconnect the generating equipment from the distribution delivery system based upon the table below:

Interconnection System Response to Abnormal Frequencies

Frequency range (Hz)	Time from beginning of event (seconds)
Greater than 60.5	0.16
Less than 57	0.16

### 3.8.12 Reconnection to distribution delivery system

The Company may require the Customer to wait up to five minutes to reconnect after the distribution delivery system voltage and frequency return to normal range and the system is stabilized. Consult the Company for details. (IEEE 1547 4.2.6)

Title: **Connecting Large Electric Generators to the Entergy Distribution System(300kVA to 20MVA)**

Effective Date:  
**May 04, 2016**

### **3.8.13 Central Business District Network**

The Company will not allow interconnection in Central Business District Underground Secondary Networks, Spot Networks and Downtown Underground Radially Fed Installations. In Central Business District Networks, Spot Networks, and Downtown Underground Radially Fed Installations a generator will have a negative effect on reliability and the safety of employees that maintain these systems. This policy will affect Spot Networks, CBD Networks and Downtown Underground Radially Fed Installations including those in New Orleans, Baton Rouge, Lake Charles, West Monroe, Beaumont, Jackson, Little Rock, Pine Bluff, and Hot Springs.

### **3.9 Inspection Prior to Operations and Additional Requirements**

The Company reserves the right, but has no responsibility either actual or implied; to impose any additional requirements necessary and to make final inspection before the system operates to verify that all requirements have been satisfied. The Customer shall be responsible for making necessary changes, at the Customer's expense; to the equipment should such changes be required.

### **3.10 Responsibility for Customer's Operations**

The Company is not responsible for proper operations of the Customer's generation facilities upon connection to the distribution system.

### **3.11 Responsibility for Customer's Maintenance**

The maintenance of the Customer's electrical equipment is their sole responsibility. The Customer will maintain records of such maintenance activities, which the Company may review at reasonable times. For generation systems greater than 50 kW, a log of generator operations shall be kept. At a minimum, the log shall include the date, generator time on, and generator time off, and megawatt and megaVAR output. Maintenance records should be made available for the Company's inspection upon request. The Company reserves the right to inspect the records, but has no responsibilities for maintenance either actual or implied.

### **3.12 Load Shed Responsibilities**

If the DG drops off line, an automatic load shed scheme shall be used to shed the Customer's load should this additional load exceed the available capacity of or causes excessive voltage sag on the distribution circuit. The load shall be shed within 10 cycles of the generator dropping off line. Such requirements shall be noted in the contract and communicated to the appropriate Operations Information Center.

For Customers whose DG operations are described by Case 2, Case 3, or Case 4, and who also have a contract for stand-by or maintenance power, arrangements should be made in the design of the Customer's system to allow for load shed under emergency conditions on the distribution delivery system.

Title: **Connecting Large Electric Generators to the Entergy Distribution System(300kVA to 20MVA)**

Effective Date:  
**May 04, 2016**

### **3.13 Protection/Interface Requirements**

Protecting both the Customer's facilities and the Company's facilities are of great importance. Proper protective systems shall be established in the design phase and confirmed prior to start-up of the Customer's generation facilities. **An interconnection between the Company and the Customer will not be allowed prior to the proper coordination of protective devices.** The Customer shall be responsible for providing to the Company the necessary documentation certifying that maintenance and testing have been satisfactorily performed.

#### **3.13.1 Changes to Company Fault Interruption Equipment**

A generator source on the distribution system will provide an additional source of fault current to the distribution system. It is possible that the Customer's contribution will require the existing coordination of fault interrupting devices on the distribution feeder be changed. The Customer will be responsible for cost of these changes to the Company's system. It is also possible that the Customer's contribution will increase the available fault current on the distribution system beyond the interrupting capability of the existing devices on the distribution system. The Customer may be required to limit their fault current. Should the Company also be required to make changes, the Customer shall pay the cost of the required changes. The issues will be examined on a case by case basis.

#### **3.13.2 Tests of the Customer's Equipment**

The Company reserves the right, but has no responsibility either actual or implied, to observe the Customer's tests and/or inspection of any of the Customer's protective equipment that is essential to the interconnection, including relays, circuit breakers, protective devices and related equipment. Inspection may include simulated test tripping of the Customer's interconnection breakers by the protective relays to verify all protective set points and relay/breaker trip timing prior to connection to the Company system.

The Customer shall provide the Company with notice at least two weeks before the initial energizing and start-up testing of the Customer's generating equipment so that the Company may witness the testing of any equipment and protective systems associated with the interconnection.

#### **3.13.3 Specifying Protective Equipment**

The Company will have the right to specify certain protective devices, including relays and circuit breakers that the Customer must install. The Company will specify all relay settings on the intertie. Settings of interconnection protective devices on the Customer's system will be specified by the Customer, but will be checked, coordinated with, and reviewed by the Company before application and subsequent modification.



Title: **Connecting Large Electric Generators to the Entergy Distribution System(300kVA to 20MVA)**

Effective Date:  
**May 04, 2016**

### 3.13.4 Service Interruption Equipment

Circuit breakers or other interrupting devices at the Point of Common Coupling must be capable of interrupting maximum available fault current. If facilities are larger than 1MVA and an inverter or similar system is used, consult Company for additional requirements.

### 3.13.5 Exception to Automatic Disconnect Equipment Requirements

Generator systems which require an AC source to operate, such as an induction generator, are not required to have an automatic fast disconnect means if the VAR support is provided by the Company. Also, a study must be conducted to determine if the capacitors on the distribution system could continue to energize the generator when the distribution feeder is not energized. Unless supported by capacitor banks when the distribution feeder is not energized, these systems will not produce output on loss of the AC source and will generally function as an induction motor. They will be allowed to coast down. The Customer is still required to provide a manual means for isolating the generator from the system so that re-energizing the distribution system will not energize the generator.

### 3.13.6 Fault Interrupting Device

A fault-interrupting device must be installed at the point of intertie between the Company and the Customer. The device could be single-phase fuses with a group operated load break switch or a three phase breaker. The choice will be the Company's and will be made on a case by case basis depending on location, available fault current, and size of the facility.

### 3.13.7 Equipment to Block Energizing Dead Circuits

**Under no condition will the Customer be permitted to energize a non-energized Company distribution circuit.** Equipment to effectively block the Customer from energizing a non-energized Company circuit shall be installed.

## 3.14 Control, Protection and Safety Equipment Requirements for Specific Technologies

Different technologies have some unique requirements. The specifications in this section list those requirements unique to the technologies.

### 3.14.1 Synchronous Generators

For a Customer's synchronous generator, circuit breakers shall be three-phase devices with electronic or electromechanical control. The Customer is solely responsible for properly synchronizing its generator with the distribution delivery system. The excitation system response ratio shall be 0.5 or greater. The generator's excitation system(s) shall conform, as near as reasonably achievable, to the field voltage versus time criteria specified in American National Standards Institute Standard C50.13 latest version in order to permit adequate field forcing during transient conditions. For generating systems greater than one MW the Customer shall maintain the automatic

Title: **Connecting Large Electric Generators to the Entergy Distribution System(300kVA to 20MVA)**

Effective Date:  
**May 04, 2016**

voltage regulator (AVR) of each generating unit in service and operable at all times. If the AVR is removed from service for maintenance or repair, the Company's dispatching office shall be notified.

### **3.14.2 Induction Generators and Inverter Systems**

Induction generation may be connected and brought up to synchronous speed (as an induction motor) if it can be demonstrated that the initial voltage drop measured on the distribution delivery system side at the Point of Common Coupling is within the allowable visible flicker standard (see § 3.8.11). Otherwise, the Customer may be required to install hardware or employ other techniques to bring voltage fluctuations to acceptable levels.

Line-commutated inverters do not require synchronizing equipment.

Self-commutated inverters whether of the utility-interactive type or stand-alone type shall be used in parallel with the distribution delivery system only with synchronizing equipment.

### **3.15 Susceptibility to Transmission Faults**

A Customer connected to the distribution system might be affected by faults occurring on the Company's transmission system. A member of the Company's System Protection Department should review the proposed generation facilities to make recommendations concerning the Customer's susceptibility to transmission faults.

### **3.16 Synchronizing Requirements**

The Customer shall be solely responsible for synchronizing and properly connecting and disconnecting its electrical system relative to parallel operation with the Company's system. The Customer shall provide an automatic or semi-automatic synchronizing scheme to prevent the closing of its circuit breaker when the two electrical systems are out of synchronism. (See § 3.8.11 Frequency.)

### **3.17 Summary of Protective Function Requirements**

The size of the DG facility dictates many of the functional requirements. These sections summarize the required functions by the installed capacity of the facilities.

#### **3.17.1 All Facilities**

All facilities must have function summarized in the Distributed Generation Technical Requirements Compliance Checklist and

- an over-voltage trip,
- an under-voltage trip,
- an over/under frequency trip,

Either a ground over-voltage or over-current trip relay scheme depending on the grounding system as specified by the Company.

Title: **Connecting Large Electric Generators to the Entergy Distribution System(300kVA to 20MVA)**

Effective Date:  
**May 04, 2016**

Will be investigated based under minimum feeder load circumstances. This investigation may alter the requirements.

For generating facilities not exporting power, a reverse power-sensing scheme is also required. (This requirement may be waived if the generator is rated at less than the minimum load of the Customer.)

### **3.17.2 Facilities Rated More than 2MVA**

The facilities must have everything discussed in section 3.17.1. The facility shall have an automatic voltage regulator. A telemetry/transfer trip will be investigated and may also be required by the Company as part of a transfer tripping or blocking protective scheme. If Company is called upon to wheel or move power across its transmission system Entergy's OATT (Open Access Transmission Tariff), FERC orders 2006, 2006A and 2006B, NERC Reliability Standard FAC-002 (latest version), Entergy Transmission Standard PM3901, Generator Interconnection Customer Requirements, and Entergy Transmission Standard AM3901 (Latest Edition) Affected System New Facilities Coordination will apply. Consult the Company.

### **3.17.3 Facilities Rated More than 10MVA**

The facilities must have everything discussed in section 3.17.2. Facilities in this range may be covered under Entergy Transmission Standard PM3901, *Generator Interconnection Customer Requirements* for provisions to connect to the Company's transmission system for voltages above 34.5 kV.

### **3.18 Metering Requirements**

The Attachments (6.0) outlines the three metering arrangements approved by the Company. The Customer has the right to choose the metering option that best fits a particular situation. The Customer will pay any additional metering costs if the requested metering setup exceeds the configurations approved in Attachments.

The generator step-up transformer losses will be the Customer's responsibility, therefore the metering shall be at the distribution voltage level. Rate considerations will reflect these requirements.

### **3.19 Communication Criteria for Requiring Telemetry**

Telemetry requirements will be based on the cases described under **Section 1.2, Scope:**

1. Cases 1 through 4, no telemetry will be required.
2. Cases 5 and 6 may or may not require telemetry depending on the output of the Customer's generating facility.
  - A. For Customers' installations generating less than 1MVA:
 

The Customer shall furnish a telephone number that is manned during all hours of operation where the Company dispatcher can contact the Customer in the event of trouble on the distribution circuit serving the Customer.

Title: **Connecting Large Electric Generators to the Entergy Distribution System(300kVA to 20MVA)**

Effective Date:  
**May 04, 2016**

- The Company **may** require a dedicated telephone circuit at the site of the Customer's intertie to provide communication with the Company's dispatcher.
- B. For Customer's installation generating 1MVA or greater:
- The Company and the Customer shall maintain operating communications at the Customer's expense with the Company's system dispatcher or the designated representative. The operating communications shall include, but not be limited to, system paralleling or separation, scheduled and unscheduled shutdowns, equipment clearances and hourly and daily load schedules and reports.
- An RTU (Remote Terminal Unit) shall be installed by the Customer to gather accumulated and instantaneous data to be telemetered to a specified Company control center. The Company shall approve the RTU and its configuration. Instantaneous analog Watt flow and VAr flow information and breaker/switch status must be telemetered directly to the center. These signals will display the current status of the generation facility. Additionally, these signals will be used as input to the Company's control center computer system. These inputs will assist in providing decisions on economic dispatch for optimum system operation. Additional programs within the control center computer system will use the input data to assist in numerous other areas of system operation, such as load forecasting, generation scheduling and maintenance, contingency analysis, and training.

These interconnected facilities must be properly integrated into the Company communication and control systems.

Case 7 will always require the Customer to install telemetering as described in 2B above regardless of the size of the generating facilities.

### **3.20 Transformation Requirements**

**Customers are encouraged to contact the Company early in the process, and learn about Customer requirement and specific requirements due to their location on the electric grid.** Customers may call 1 800 ENTERGY to get a local engineer assigned.

If Customers' existing generation facilities need additional transformation, a different grounding system or other upgrades, the Customer shall be required to design, pay for and maintain all upgrades necessary to comply with Company's Connection Standards.

The Customer's grounding, transformer, relaying and generator system shall be designed to handle the normal imbalance on the distribution system.

Customer's additional generation related transformation and other facilities should be owned, operated and maintained by the Customer. At Entergy's option, a standard Entergy transformer/ transformer bank may be provided at Customer expense.

---

Title: **Connecting Large Electric Generators to the Entergy Distribution System(300kVA to 20MVA)**

---

Effective Date:  
**May 04, 2016**

---

**For Cases 3-7**, the Customer shall monitor the Company's distribution system and react based upon specifications in this Standard. Grounded Wye to Grounded Wye transformers are preferred with no impedance or resistance grounds. (see next page)

Title: **Connecting Large Electric Generators to the Entergy Distribution System(300kVA to 20MVA)**

Effective Date:  
**May 04, 2016**

Feasibility studies are required to design/ specify a monitoring method (transfer trip or another method of reading the Entergy feeder) if:

- Zero sequence path isolation occurs, some examples
  - Impedance/resistance grounds limit fault current and fault signal.
  - Ungrounded connections/ configurations between the Customers generators and Entergy may not consistently detect faults on the Company's distribution system.
- Delta configurations exist because they:
  - balance the Company's distribution system load per phase, making the feeder difficult to monitor
  - may be ungrounded.

#### 4 References

IEEE 1547 Standard for Interconnecting Distributed Resources with Electric Power Systems

FERC Orders 2006, 2006A, 2006B

IEEE *Guide for Protective Relaying of Utility-Consumer Interconnection* C37.95 (Latest revision)

IEEE 519 *Recommended Practices and Requirements for Harmonic Control in Electric Power Systems*, (Latest Edition)

IEEE 141 *Recommended Practice for Electric Power Distribution for Industrial Plants*, (Latest Edition)

ANSI C84.1 (Latest Edition)

*Connecting Small Electric Generators to the Entergy Distribution System (less than 300kVA)* (Latest Edition), Entergy Standard Number DR0702

*Entergy Customer Installation Standards for Electric Service (Latest edition)*

Entergy Power Quality Standards for Electric Service, latest edition

Entergy Transmission Standard AM3901 (Latest Edition) Affected System New Facilities Coordination

Entergy Transmission Generator Interconnection Customer Requirements Standard PM3901 (Latest Edition)

NERC Reliability Standard FAC-002 (latest version)

Entergy's OATT (Open Access Transmission Tariff), latest version

Operating Company Agreements

#### 5 Responsibilities

##### 5.1 Interpretation

Interpretation of this document is the responsibility of the Manager of Standards & Engineering Services or his designee with concurrence of the Asset Planning Department and the Distribution Business Department.

---

Title: **Connecting Large Electric Generators to the Entergy Distribution System(300kVA to 20MVA)**

---

Effective Date:  
**May 04, 2016**

---

## 5.2 Deviation

The Manager of Standards & Engineering Services is responsible for ensuring that this document is written in accordance with federal, state, and national code requirements. Any deviations must be reported to the Manager of Standards & Engineering Services for consideration for inclusion in this document.

In the event that standards for a specific unit or facility are not set out in this document, the Customer may interconnect a facility using mutually agreed upon technical standards, as authorized by the Manager of Standards & Engineering Services. Deviation from this document may be made only with the consent of the Manager of Standards & Engineering Services or his designee. No other employee is granted independent authority to grant deviations.

**6 Attachments - Metering Arrangements**

Cases 1-4 (§1.2page5)  
Displaced load only. Supplier does not sell any power.  
Meter measures power in for billing.

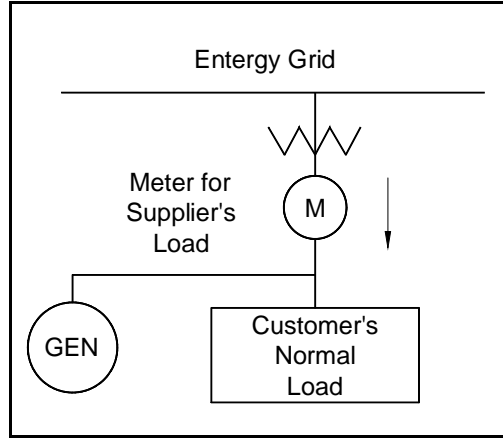

**Case 5** (§1.2page5) & Maybe Case 7  
Power Supplier sells excess generation.  
One meter measures power in for billing.  
One meter measures power out for payment to supplier.  
In many cases one meter can perform both functions. Consult the Company

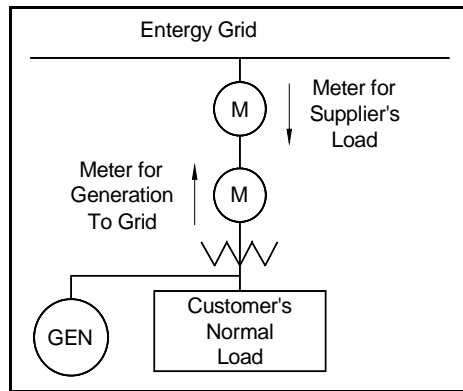

Case 6 & Sometimes Case 7 (§1.2page5)  
Power Supplier sells all generation  
One meter measures power out for payment to supplier.

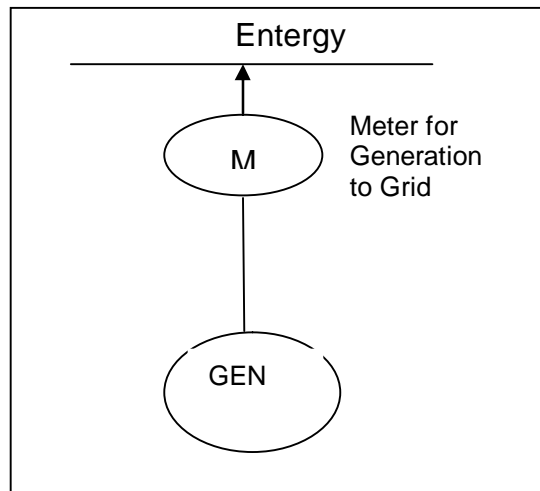



Title: **Connecting Large Electric Generators to the Entergy Distribution System(300kVA to 20MVA)**

Effective Date:  
**May 04, 2016**

## Revisions

Rev 12	Classified as Manual & reviewed/ reorganized for easier reading	4/30/12								
Rev 13	<p><b>§1. 2 Scope</b> Case 7 added Transmission Company involvement required.</p> <p><b>§3.20 Transformation Requirements</b> rewritten to explain Zero sequence path isolation</p> <p><b>§3.8.11 Frequency</b> Interconnection System Response to Abnormal Frequencies</p> <table border="1"> <thead> <tr> <th>Generator size</th> <th>Frequency range (Hz)</th> <th>Time from beginning of event (seconds)</th> </tr> </thead> <tbody> <tr> <td rowspan="2">Greater than 30 kVA</td> <td>Greater than 60.5</td> <td>0.16</td> </tr> <tr> <td>Less than 59.8</td> <td>0.16</td> </tr> </tbody> </table> <p>++ used to say Less than 59.8 to 57 --Adjustable 0.16 – 300 sec (Consult Entergy)</p> <p>Added to Application Manufacturer certified relay response curves submitted _____</p> <p>Put in more noticeable place in Application Customer's Generation Case (§1.2-page )_____</p> <p>Layout sketch showing lockable, "visible" disconnect device for hot circuits? _____</p> <p><b>§8 Attachments</b> - Metering Arrangements Metering associated with Cases in §1.2</p>	Generator size	Frequency range (Hz)	Time from beginning of event (seconds)	Greater than 30 kVA	Greater than 60.5	0.16	Less than 59.8	0.16	8/7/13
Generator size	Frequency range (Hz)	Time from beginning of event (seconds)								
Greater than 30 kVA	Greater than 60.5	0.16								
	Less than 59.8	0.16								
Rev 14	Changed Connecting Large Electric Generators to the Entergy Distribution System lower range from 500 kVA to 300 kVA to align with the less than 300kVA limit for Net Metering Inquiry and Application Processes Standard due to minimum impact on the Distribution System. Also unit standardization.	5/4/16								

Title: **Connecting Large Electric Generators to the Entergy Distribution System(300kVA to 20MVA)**

Effective Date:  
**May 04, 2016**

Page 1 of 4

**8 Application**

Return Completed Application to your local Entergy representative or if you do not have an assigned representative contact 1-800 - Entergy to be assigned a representative.

**The Customer may want to have the vendor of the equipment or a Professional Engineer help fill out this application and checklist.**

Customer's Name: \_\_\_\_\_

Address: \_\_\_\_\_

Contact Person: \_\_\_\_\_

Telephone Number: \_\_\_\_\_ e-mail: \_\_\_\_\_

Fax: \_\_\_\_\_

Service Point Address:

Information Prepared and Submitted By: (Name and Address)

Signature \_\_\_\_\_

Customer's Generation Case (§1.2-page 4) \_\_\_\_\_

Layout sketch showing lockable, "visible" disconnect device for hot circuits?

\_\_\_\_\_ Yes

The Customer or Customer's designated representative shall supply the following information. All applicable items must be accurately completed in order that Entergy may effectively evaluate the Customer's generating facilities for interconnection with the Company's distribution system.

	Source of Power Generation: (Natural Gas Turbine Generator, Solar, Wind, Hydro, Geothermal, Biomass, Fuel Cell, Micro turbine, other(state or describe))	Type of Interface ( Inverter, Synchronous, Induction or other(state or describe))
Manufacturer:		
Model:		
Number of Units		
Generator Rating (s) (kW): (95°F at location)		
Generator Rating (s) (kVA):(95°F at location)		
Power Factor:		
Voltage Rating:		
Ampere Rating:		

Title: **Connecting Large Electric Generators to the Entergy Distribution System(300kVA to 20MVA)**

Effective Date:  
**May 04, 2016**

Short Circuit Current:		
------------------------	--	--

(Note: If more units will be used, complete a separate attachment with the information above)

Title: **Connecting Large Electric Generators to the Entergy Distribution System(300kVA to 20MVA)**

Effective Date:  
**May 04, 2016**

**Application**

**page 2 of 4**

Customer/Company \_\_\_\_\_ Date \_\_\_\_\_

Number of Phases: \_\_\_\_\_

Frequency: \_\_\_\_\_

Short Circuit Current: \_\_\_\_\_

Will you supply the necessary VAr requirements? \_\_\_\_\_ Yes \_\_\_\_\_ No

Do you plan to export power? \_\_\_\_\_ Yes \_\_\_\_\_ No

If Yes, maximum amount expected: \_\_\_\_\_

Expected Energizing and Start-up Date: \_\_\_\_\_

Normal Operation of Interconnection: (examples: provide power to meet base load, demand management, standby, back-up, other (please describe)) \_\_\_\_\_  
\_\_\_\_\_

One-line diagram attached: \_\_\_\_\_ Yes

(Adequate drawings of the Customer's proposed facility, which will include a one line diagram and proposed relay systems, must be submitted to the Company for review during the planning stage. Additional drawings may be required on a case by case basis. (3.8.4))

Manufacturer certified relay response curves submitted/included \_\_\_\_\_

List of specifications on protective devices attached? \_\_\_\_\_

Has the generator Manufacturer supplied its dynamic modeling values to Entergy?

Distributed Generation Technical Requirements Compliance Checklist included as attachment with answers to requirements based upon Customer's Generation Case  
\_\_\_ Yes \_\_\_ No

[CUSTOMER NAME]

BY: \_\_\_\_\_

TITLE: \_\_\_\_\_

DATE: \_\_\_\_\_

Title: **Connecting Large Electric Generators to the Entergy Distribution System(300kVA to 20MVA)**

Effective Date:  
**May 04, 2016**

Application  
Customer/Company \_\_\_\_\_

Date \_\_\_\_\_

page 3 of 4

**9 Distributed Generation Technical Requirements Compliance Checklist**

**The Customer is responsible for all the applicable requirements in this Standard.** This checklist is a guide to the requirements that can be found in detail in distribution standard DR07-01, (Section numbers are provided after each requirement.) Two objectives must be met to arrive at compliance by the proposed installation:

**Safety:** The Customer’s facilities will be held to the same standard of care, as the Company is required to maintain. In addition, the safety of the general public and the personnel and equipment of the Company shall in no way be reduced or impaired as a result of the interconnection.

**Customer Impact:** The quality, reliability and the availability of service to the Company’s other Customers shall not be diminished or impaired as a result of the Interconnection.

**(Customer shall supply Description of Proposed Compliance information consistent with the Generation Case)**

Customer’s Generation Case (§1.2-page 4)\_\_\_\_\_

**Customers 1 MVA and larger should also see sections 3.17, 3.19**

Entergy Requirement	Description of Proposed Compliance	Adequate (Y/N)	Comments
<b>Required for Case 2</b>			
1. Provide accessible gang operated load break switch. (3.2)			
<b>Also required for Case 3</b>			
2. Block generator from energizing dead circuits. (3.13.3.4)			
3. Synchronize system within ½ cycle. (3.16)			
4. Appropriate Transformation (3.20)			
5. Specify protective devices and settings. (3.13,3.14 & 3.17)			
6. Supply reactive power. (3.8.7 & 3.8.8)			

Title: **Connecting Large Electric Generators to the Entergy Distribution System(300kVA to 20MVA)**

Effective Date:  
**May 04, 2016**

**Additional Requirements for Cases 4,5,6 & 7 on following page**

**Application page 4 of 4** Customer/Company \_\_\_\_\_ Date \_\_\_\_\_  
Customer's Generation Case (§1.2-page 4)

Entergy Requirement	Description of Proposed Compliance	Adequate (Y/N)	Comments
<b>Requirements for Cases 2 &amp; 3 which apply to Cases 4,5,6&amp; 7 on previous page</b>			
<b>Also required for Case 4</b>			
7. Disconnect intertie within 10 cycles of a service interruption or fault. (3.8.9, 3.8.11, 3.13.3, 3.15 & 3.20)and do not come back on the system for five minutes (3.8.12)			
8. Install fault-interrupting device (3.13.3.3)			
9. Limit voltage flicker, harmonic voltage and current. (3.8.10)			
10. Limit voltage surges and sags to range of ±10% of nominal voltage. (3.8.9)			
11. Limit abnormal frequency (3.8.11)			
<b>Also required for Cases 5-6</b>			
12. Install metering and telemetering equipment. (3.18 & 3.19)			
13. Maintain continual operating communications. (3.19)			
<b>Also Required for Case 7</b>			
14. Transmission Standard PM3901			
15. FERC Orders 2006, 2006A & 2006B (see 4.0 References)			

**Exhibit H-3**  
**Distribution Inter-Connection Process**



Title: <b>DISTRIBUTION INTER-CONNECTION PROCESS</b>   Effective Date: <b>May 04, 2016</b>	
Prepared By: Michael R. Gray Distribution Design Basis / Standards	Approved By: James R. Hickman Manager of Distribution Design Basis / Standards

### 1.0 Purpose

The Distribution Inter-Connection Process is the overall process for queuing, processing, executing, and maintaining Interconnection Agreements for Generators 20MVA and smaller in size connecting to the Entergy System via Distribution

### 2.0 References

- 2.1 *Net Metering Inquiry and Application Process*, Distribution Standard Number DR07-04, latest version
- 2.2 *Connecting Large Electric Generators to the Entergy Distribution System ( 300kV to 20MVA)*, Standard Number DR07-01, latest version (includes application)
- 2.3 *Connecting Small Electric Generators to the Entergy Distribution System (less than 300kVA)*, Standard Number DR07-02, latest version (includes application)
- 2.4 *Entergy Small Generator Interconnection Procedures, Transmission Procedure RC-AD-055* latest version
- 2.5 *Small Generator Interconnection Agreement*, latest version

### 3.0 Definitions

- 3.1 Customer Relations – In Distribution may be Customer Service Manager, Manager, Major Accounts, and Account Service Manager.
- 3.2 CUTD - Customer Technical Design, an internal Entergy document that assigns a project to Distribution Design for processing
- 3.3 Distribution Voltage – Below 69kV. These Customers are covered by this Standard
- 3.4 Transmission Voltage – 69kV and higher. These customers are referred to Transmission and the Entergy Small Generator Interconnection Procedures
- 3.5 FERC Jurisdiction – Any Small Generation Interconnection Customer engaging in interstate commerce. These customers are referred to Transmission and the Entergy Small Generator Interconnection Procedures
- 3.6 Interstate Commerce – Wholesale electric marketing or any electric power purchase agreement not between the Small Generator Interconnection Customer (or their agent) and the connecting utility
- 3.7 Small Generator Interconnection Customer – Any customer desiring to interconnect a generator to the Entergy system with a total capacity less than or equal to 20 MVA.
- 3.8 Pre-interconnection study - A study or studies that may be undertaken by the Company in response to its receipt of a completed application for interconnection and parallel operation with the distribution delivery system. Pre-interconnection studies may include, but are not limited to:
  - 3.8.1 Scoping meetings/Studies *includes*
    - 3.8.1.1 A fact finding meeting/telecom with Customer and discussion of Customer responsibilities and requirements and applicable policies. (Customer Relations and Asset Planning)
    - 3.8.1.2 Asset Planning to determine if interference with the system protective equipment may occur, electricity may flow back to the substation and impact transmission, available fault current, capacitor bank impact, frequency, and voltage may be effected under normal and worst case situations. Conductors / Lines or other devices and elements that may be undersized or otherwise need settings changes as a result of the proposed generation



- 3.8.1.3 Discussion/Meeting with Customer to either
  - 3.8.1.3.1 If no impacts on grid are identified, accept the project and Customer Relations presents a contract, or
  - 3.8.1.3.2 Share potential impact on grid and future studies necessary, advise estimated costs of chosen study(s) and may provide order of magnitude estimates on facilities costs.
  - 3.8.1.3.3 If transmission is to be involved to discuss this with Customer and get Transmission to contact Customer and discuss *Energy Small Generator Interconnection Procedures* and other policies or procedures involved.
- 3.8.1.4 Product is the minimum information for attaching a small distributed generation unit at a particular location on the distribution system or results in identifying the necessity of further engineering studies or if transmission involvement is necessary.
- 3.8.2 Feasibility Study – A formal study identifying
  - 3.8.2.1 Any system protection equipment short circuit capacity limits exceeded,
  - 3.8.2.2 Thermal overload, frequency or voltage limit violations resulting from the interconnection,
  - 3.8.2.3 Initial review of grounding requirements and coordination.
  - 3.8.2.4 Product is initial and non-binding estimates of facilities, cost to interconnect and identification of further studies needed and their cost.
  - 3.8.2.5 Entergy requires a \$1,000 deposit for the Feasibility Study. Study is done at Customer cost.
- 3.8.3 System Impact Study – shall
  - 3.8.3.1 Identify and detail the electric system impacts that would result if the proposed Small Generating Facility were interconnected without project modifications or electric system modifications, focusing on the adverse system impacts identified in the feasibility study,
  - 3.8.3.2 Study potential impacts, including but not limited to those identified in the scoping meeting.
  - 3.8.3.3 Product is an evaluation of the impact of the proposed interconnection on the reliability of the electric system.
  - 3.8.3.4 Entergy requires a \$50,000 deposit for the System Impact Study. Study is done at Customer cost.
- 3.8.4 Facilities study –
  - 3.8.4.1 Shall specify and estimate the cost of the equipment, engineering, procurement and construction work (including overheads) needed to implement the conclusions of the system impact study(s).
  - 3.8.4.2 Entergy requires a deposit of the good faith estimated costs for the facilities study from the Customer. Study is done at Customer cost.
- 4.0 Customer Request
  - 4.1 Customer contacts Entergy about connecting an electric generator to the system
  - 4.2 Inquiries received from
    - 4.2.1 Call Center are forwarded to Appropriate local Distribution Design Group via a CUTD

- 4.2.2 Internet are forwarded to Distribution Design
- 4.2.3 Known Entergy contacts should be forwarded to Distribution Design via a CUTD
- 4.3 Distribution design with the as needed assistance of Customer Relations, Asset Planning Engineer, Distribution and Senior Wholesale Executive, Transmission Project Development contacts the customer to verify customer request and answer questions
  - 4.3.1 Customer Relations will answer any questions about rates
  - 4.3.2 If less than 300kVA, and connected at Distribution Voltage – Below 69kV, and no impact on Distribution, Distribution Design will follow
    - 4.3.2.1 *Net Metering Inquiry and Application Processes Standard*, if qualified, or
    - 4.3.2.2 Manage remaining customer interface in accordance *Connecting Small Electric Generators to the Entergy Distribution System (less than 300kVA)*
  - 4.3.3 Distribution Design will handoff to Asset Planning if
    - 4.3.3.1 Generation connected at Transmission Voltage – 69kV and higher, or
    - 4.3.3.2 Customer wants to wheel power across the transmission grid, or
    - 4.3.3.3 Generator greater than 300kVA
    - 4.3.3.4 Generator impacts Distribution line sizing, coordination, etc.
  - 4.3.4 Asset Planning will handoff to Senior Wholesale Executive, Transmission Project Development if
    - 4.3.4.1 Generation connected Transmission Voltage – 69kV and higher, or
    - 4.3.4.2 Customer wants to wheel power across the transmission grid (FERC jurisdiction), or
    - 4.3.4.3 Generator greater than 20MVA
- 5.0 Customer submits appropriate Distribution interconnection application (see references 2.2& 2.3)
  - 5.1 Applications received via
    - 5.1.1 Call Center are forwarded to Appropriate Distribution Design Group via a CUTD
    - 5.1.2 Internet are forwarded to Distribution Design
    - 5.1.3 Known contacts are forwarded to Distribution Design via a CUTD
  - 5.2 Distribution design receives and verifies application
    - 5.2.1 If less than 300kVA, and connected at Distribution Voltage – Below 69kV, and no impact on Distribution, Distribution Design will follow
      - 5.2.1.1 *Net Metering Inquiry and Application Processes Standard*, if qualified, or
      - 5.2.1.2 Manage remaining customer interface in accordance *Connecting Small Electric Generators to the Entergy Distribution System (less than 300kVA)*
    - 5.2.2 Distribution Design will handoff to Asset Planning if
      - 5.2.2.1 Generation connected at Transmission Voltage – 69kV and higher, or
      - 5.2.2.2 Customer wants to wheel power across the transmission grid, or
      - 5.2.2.3 Generator greater than 300kVA
      - 5.2.2.4 Generator impacts Distribution line sizing, coordination, etc.
    - 5.2.3 Asset Planning will handoff to Senior Wholesale Executive, Transmission Project Development if
      - 5.2.3.1 Generation connected Transmission Voltage – 69kV and higher, or
      - 5.2.3.2 Customer wants to wheel power across the transmission grid, or
      - 5.2.3.3 Generator greater than 20MVA

- 6.0 Asset Planning contacts and discusses with Customer, makes site visit and performs Scoping Study. Asset Planning determines:
- 6.1 If Feasibility Studies and System Impact Studies are required and
  - 6.2 The potential for Transmission Grid impact i.e.
    - 6.2.1 Generation connected at a Transmission Voltage, or
    - 6.2.2 Customer wants to wheel power across the transmission grid, or
    - 6.2.3 Electric power will flow onto Transmission Grid
- 7.0 If the Transmission System is impacted(as defined in 6.2), and generator is to be connected at Distribution Voltage the Asset Planner and Customer Relations must contact the Transmission Project Development group for feedback and to follow Transmission procedure and process. If Transmission is involved other studies may be done on Transmission side (see *Entergy Small Generator Interconnection Procedures and Small Generator Interconnection Agreement*)
- 8.0 If Feasibility Studies and System Impact Studies are required Customer Relations is notified to setup a meeting with the customer via conference calls or face to face.
- 9.0 Customer Relations obtains from customer a signed pre-interconnection study agreement (letter agreement) and deposit(s) which allows Asset Planning to proceed with the Feasibility Study and System Impact Study if required.
- 10.0 Interconnection agreements are signed only after Distribution and (if necessary) Transmission issues are resolved.
- 11.0 If the customer wishes to terminate the Interconnection Process at any time, Customer must notify assigned Entergy Customer contact of this intent.

12.0 Revisions

01	Changed Connecting Large Electric Generators to the Entergy Distribution System lower range from 500 kVA to 300 kVA to align with the less than 300kVA limit for Net Metering Inquiry and Application Processes Standard due to minimum impact on the Distribution System. Also minor units standardization.	5/4/16
----	--	--------

**Bidder Registration Agreement**  
**(2016 Request For Proposals For Long-Term Renewable Generation Resources**  
**For Entergy New Orleans, Inc.)**

This Bidder Registration Agreement (“Agreement”) is entered into by Bidder (as described in the attached Bidder Registration Form) in connection with the 2016 Request For Proposals For Long-Term Renewable Generation Resources For Entergy New Orleans, Inc. (including all appendices, the “RFP”), the terms of which are posted on the RFP website, <https://spofossil.entergy.com/ENTRFP/SEND/2016ENOIRenewableRFP/Index.htm>.

Bidder is providing this Agreement to and for the benefit of Entergy Services, Inc. and its successors and assigns (“ESI”). Bidder acknowledges that, once executed and delivered to ESI by Bidder, ESI is entitled to rely on this Agreement, and Bidder hereby waives and disclaims any legal or equitable defense derived from or otherwise arising out of ESI’s not being a signatory to this Agreement.

Bidder acknowledges and agrees that (i) a Proposal Submittal Fee (as described in Section 5.2 of the main body of the RFP) will be due and owing for each proposal Bidder has registered under this RFP; (ii) the completion and execution of this Agreement (including the Bidder Registration Form) by an authorized representative of Bidder and the delivery thereof to ESI, via courier or electronic mail (as a .pdf attachment) to the RFP Administrator (as defined in Section 1.5 of the main body of the RFP), by 5:00 p.m. CPT on the last day of the Bidder Registration Period (as provided in the RFP) are requirements for Bidder’s continued participation in the RFP process; and (iii) Bidder’s registration information will not be complete unless and until Bidder delivers to ESI, and ESI has received, by 5:00 p.m. CPT within three (3) business days after the last day of the Bidder Registration Period, an original of the duly executed Agreement. Bidder’s delivery of this Agreement to ESI will serve as confirmation of Bidder’s commitment and obligation, in the event Bidder submits one or more proposals in the RFP, to duly complete, sign, and deliver to ESI the Proposal Submission Agreement. **Only Bidders registered in accordance with the RFP will be permitted to submit proposals in the RFP, and only proposals registered in accordance with the RFP will be eligible for the Proposal Submission Process.**

Within three (3) business days after the last day of the Bidder Registration Period, ESI will invoice Bidder for the aggregate amount of the Proposal Submittal Fee(s) due and owing to ESI. Bidder will remit to ESI, by wire transfer to the wire address set forth in such invoice, full payment of such invoiced amount by no later than the date specified in the applicable RFP Schedule. Any proposal for which the corresponding Proposal Submittal Fee(s) has not been paid by the due date for Proposal Submittal Fees will be considered non-conforming and eliminated from further consideration under the RFP.

IN WITNESS WHEREOF, Bidder has executed this Agreement as of \_\_\_\_\_, 2016.

\_\_\_\_\_  
Authorized Signature

\_\_\_\_\_  
Name

**Bidder Registration Form**  
**(2016 Request For Proposals For Long-Term Renewable Generation Energy Resources**  
**For Entergy New Orleans, Inc.)**

Please enter the information called for in the left column (Requested Information) in the adjacent blank cell in the right column (Bidder Information).

Requested Information	Bidder Information
Bidder Name	
Co-Bidder Name(s) (if applicable)	
Bidder Contact Name	
Bidder Address	
Bidder Contact E-mail Address	
Bidder Phone Number	
Bidder Fax Number	
Bidder State of Incorporation/Organization	
Form of Bidder Entity (Corporation, Partnership, etc.)	
Bidder Credit Support Provider	
Bidder Federal Tax ID (xx-xxxxxxx)	
Generation Facility Name	
Generation Facility Location	
Owner of Generation Facility	
Marketer of Generation Facility	
Number of Proposals Bidder Intends To Submit in the RFP	
Proposal Type (PPA or Acquisition) for each Proposal to be Submitted	
Technology Type (Wind, Solar Photovoltaic, or Run-of-River Hydroelectric) for each Proposal to be Submitted	
Resource Type (Developmental or Existing) for each Proposal to be Submitted	

## CONFIDENTIALITY AGREEMENT

This Confidentiality Agreement (this “Agreement”), entered into effective as of [ ], 2016 (the “Effective Date”), is by and between Entergy Services, Inc. (“ESI”), a Delaware corporation, and [Bidder] (“Bidder”), a [ ] [corporate form]. ESI and [Bidder] are sometimes hereinafter referred to individually as a “Party” and collectively as “Parties.”

### RECITALS:

A. ESI has issued the 2016 Request For Proposals For Long-Term Renewable Generation Resources For Entergy New Orleans, Inc. (the “RFP”) on behalf of Entergy New Orleans, Inc. (“ENOI”).

B. In connection with the RFP, the Parties and/or their respective Representatives (as defined below) may disclose to one another information that is confidential and proprietary and may enter into a transaction with each other (the “Possible Transaction”).

C. Each Party wishes to maintain the confidentiality of such information and, further, does not intend to waive any of its rights thereto.

D. As a condition to furnishing such information, each Party requires that such information be accorded confidential treatment in accordance with and subject to the provisions of this Agreement.

### AGREEMENT:

In consideration of the premises and mutual agreements contained herein, and other good and valuable consideration, the receipt and sufficiency of which are hereby mutually acknowledged, the Parties, intending to be bound, agree as follows:

1. Definitions. As used herein, “Confidential Information” means, subject to Section 2 below, all data, analyses, documents, materials and other information furnished by the Party disclosing the same (the “Disclosing Party”) or any of its Representatives to the Party receiving the same (the “Receiving Party”) or any of its Representatives in connection with the Possible Transaction, whether prior to, on or after the Effective Date, and any and all written reproductions, summaries, notes, analyses, compilations, studies, documents, and materials prepared by or for the Receiving Party or any of its Representatives to the extent containing, reflecting or based upon, in whole or in part, such data, analyses, documents, materials or other Confidential Information of the Disclosing Party disclosed pursuant hereto. Confidential Information may be in any form whatsoever, including, without limitation, writings, computer code or programs, logic diagrams, component specifications, drawings, or other media, and may be written or oral. “Representative” means, with respect to a Party, any affiliate of such Party, and any shareholder, member, manager, partner, trustee, director, officer, employee, agent, contractor, lender or potential lender, or representative, including, without limitation, legal counsel, financial advisors, ratings agency advisors, and accountants, of such Party or such affiliate.

2. Exceptions.

(a) Notwithstanding the provisions of Section 1 above, the term “Confidential Information” shall not include information that:

- (i) was, prior to disclosure, either known by or within the possession of the Receiving Party without an obligation of confidentiality binding upon the Receiving Party or otherwise in the public domain;
- (ii) is or becomes, at the time of or following disclosure, available to the Receiving Party on a non-confidential basis from a source that is not prohibited, to the Receiving Party’s knowledge, from disclosing such information by any contractual, fiduciary or other legal obligation of non-disclosure, or otherwise is or becomes part of the public domain (including pursuant to any permitted public disclosure under Section 3(a)(i) of this Agreement) other than as a result of a disclosure by the Receiving Party or any of its Representatives that is not permitted by this Agreement; or
- (iii) is independently developed by the Receiving Party or any of its Representatives without breaching any of its disclosure or use obligations under this Agreement or any other agreement.

3. Limitations on Disclosure.

(a) The Receiving Party and its Representatives may not disclose any Confidential Information received hereunder to any other person, including, without limitation, a governmental authority, except that, subject to Section 3(b) below, the Receiving Party and its Representatives may disclose Confidential Information (i) to any third party to whom the Receiving Party or its Representatives is requested or required by any judicial, regulatory or other governmental authority with jurisdiction to disclose Confidential Information (*e.g.*, by order, deposition, interrogatory, civil investigative demand, request for documents, subpoena, or similar process or rule of procedure, or by statute, rule, or regulation, or other legal requirement), or if the Receiving Party or any Representative thereof is compelled by applicable securities laws or a stock exchange listing agreement to disclose Confidential Information, but in either case only to the extent disclosure is requested or required; (ii) to any of its Representatives who are directly involved in and require access to such information in connection with the Possible Transaction; (iii) to the limited extent authorized in writing by the Disclosing Party; and (iv) with respect to [Bidder’s] Confidential Information, to the RFP’s Independent Monitor and as provided in Section 3(c). The Receiving Party agrees that any of its Representatives to whom Confidential Information is disclosed will be informed of the confidential or proprietary nature thereof and that, as between the Parties, the Receiving Party shall be responsible for any prohibited or unauthorized use or disclosure of Confidential Information by the Receiving Party or any of its Representatives that is not authorized hereunder. The term “person,” as used in this Agreement, shall be broadly interpreted to include the media (including the social media) and any individual, corporation, partnership, fund, limited liability company, trust, association, joint venture, unincorporated



organization, group, governmental entity or any department, agency or political subdivision thereof, or other entity.

(b) If the Receiving Party or any of its Representatives is requested or required to disclose Confidential Information or any portion thereof under Section 3(a)(i) above, the Receiving Party shall give, to the extent practical and legally permissible, reasonably prompt written notice of the existence and circumstances surrounding such requested or required disclosure to the Disclosing Party so that the Disclosing Party may seek, at its sole cost and expense, a protective order or other relief in the appropriate forum and/or waive compliance by the Receiving Party with the terms of this Agreement applicable to the Confidential Information requested or required to be disclosed. If the Disclosing Party determines to seek a protective order or other relief, the Receiving Party shall use good faith efforts, at the sole cost and expense of the Disclosing Party, to cooperate with the Disclosing Party in such undertaking. If, despite the Receiving Party's compliance with its obligations hereunder, such protective order or other relief is not obtained by the time at which the Receiving Party or any of its Representatives is, upon the advice of its legal counsel (including in-house legal counsel), legally compelled to make such disclosure, or the Disclosing Party waives in writing compliance with the provisions hereof, the Receiving Party or its Representatives may disclose Confidential Information without liability to the Disclosing Party hereunder, provided that the Receiving Party agrees to furnish, and to require its Representatives to furnish, only that portion of the Confidential Information legally required to be disclosed upon the advice of such legal counsel (including in-house legal counsel).

(c) [Bidder] acknowledges that the Confidential Information it or any of its Representatives discloses to ESI or its Representatives hereunder may be subject to review by regulatory bodies having jurisdiction over the retail rates and services provided by ENOI, including, without limitation, the Council of the City of New Orleans, and by the Federal Energy Regulatory Commission, or by the staffs thereof, and may be subject to formal or informal discovery by any such regulatory body or staff. In addition, [Bidder] acknowledges that all such Confidential Information may be subject to review by a district or appellate court in a proceeding involving ENOI. [Bidder] agrees that, notwithstanding anything herein to the contrary, ESI and its Representatives may, without notice to [Bidder], use and disclose such Confidential Information in testimony, applications, pleadings, evidence or in response to formal or informal discovery in any proceeding or in any non-public communication or discussion seeking or relating to approval or review by any such regulatory body or district or appellate court of the Possible Transaction or any other regulatory or judicial proceeding to which the Possible Transaction may be relevant, and in any such case, ESI will make reasonable efforts to obtain confidential treatment for such Confidential Information, including, without limitation, providing such information to the regulatory body and/or its staff under the confidentiality protections permitted by the governing rules and order of such commission. [Bidder] acknowledges and agrees that ESI and its Representatives hereunder shall be entitled to disclose to any governmental authority as a matter of right, and without seeking any confidential treatment therefor or providing notice thereof to [Bidder], the names of the parties to the Possible Transaction; the nature and type and general descriptions of the Possible Transaction; and terms of the Possible Transaction that ESI, in its good faith judgment, believes are reasonable and appropriate to include in its public application for or other public filing(s) seeking approval of the Possible Transaction by a governmental authority.

4. Limitations on Use. Absent the express written consent of the Disclosing Party, Confidential Information disclosed hereunder may be utilized by the Receiving Party and its Representatives only for the purpose of the Possible Transaction and for no other purpose.

5. Reservation of Rights. The Parties agree that: (i) all rights in or to Confidential Information disclosed pursuant to this Agreement are reserved to the Disclosing Party; (ii) subject to the express obligations of each Party set forth in this Agreement, nothing in this Agreement shall diminish or restrict in any way the rights that each Party has to market, lease, sell, or otherwise make available its products and services to any customer or third party; and (iii) no license or conveyance of any rights under any information, discoveries, inventions, or patents is granted or implied by either Party to the other under this Agreement.

6. Term. This Agreement shall commence on the Effective Date and shall continue in effect for a period of two (2) years from the Effective Date, and all obligations hereunder (other than undischarged obligations arising out of any breach of this Agreement) shall terminate and expire upon the expiration of such two-year term.

7. No Obligation to Disclose or Negotiate; Definitive Agreements. This Agreement does not and shall not be construed to obligate either Party to disclose Confidential Information to the other Party or to negotiate or to enter into any agreement as a result of the exchanges and discussions contemplated by this Agreement. Disclosure of Confidential Information shall be at the sole discretion of the Disclosing Party, subject to the terms of any other separate binding written agreement entered into between the Parties. [Bidder] acknowledges and agrees that neither ESI nor ENOI has an obligation to negotiate exclusively with [Bidder] or any other person regarding the Possible Transaction except as may be otherwise expressly provided in a subsequent written agreement. Each of the Parties acknowledges that it is sophisticated and has been advised, and will continue to be advised, by experienced counsel and, to the extent it deems appropriate, other advisors in connection with the Possible Transaction. The Parties (i) understand, acknowledge and agree that no enforceable contract or agreement providing for the Possible Transaction shall be deemed to exist unless and until one or more written agreements for the Possible Transaction (each, a “Definitive Agreement”) has been negotiated, executed and delivered by the Parties (or affiliates of the Parties); and (ii) agree that unless and until any Definitive Agreement between the Parties (or affiliates of the Parties), with respect to the Possible Transaction has been executed and delivered, and then only in accordance with the terms thereof and applicable law, neither Party nor its Representatives have or shall have any legal obligation to the other Party or its Representatives of any kind whatsoever with respect to the Possible Transaction.

8. No Warranties. Except as provided in Section 16 below or to the extent expressly set forth in any other written agreement, instrument or other document binding upon the Disclosing Party or its Representatives (as applicable), neither the Disclosing Party nor any of its Representatives (i) makes or shall be deemed to have made any representation or warranty of any kind or character as to any of its Confidential Information, including, without limitation, accuracy or completeness (and no representation or warranty as to the Confidential Information shall be deemed made or exist), or (ii) shall have any liability to the Receiving Party or any other person on any basis (including, without limitation, in contract, tort, under federal or state securities laws

or otherwise) resulting from the use of Confidential Information by the Receiving Party or any of its Representatives.

9. Return of Confidential Information.

(a) While this Agreement remains in effect, the Receiving Party, upon the Disclosing Party's written request, shall return to the Disclosing Party as promptly as practicable, but in no event later than thirty (30) days from the date such request is received, all Confidential Information provided to the Receiving Party and in its possession or the possession of its Representatives. In lieu of returning the information as provided herein, the Receiving Party may destroy all Confidential Information provided by, and shall certify in writing such destruction to, the Disclosing Party. Notwithstanding the return or destruction of the Confidential Information, the Receiving Party shall continue to be bound by its obligations hereunder for the duration of the term of confidentiality hereof. Counsel for the Receiving Party may retain one (1) copy of Confidential Information (in whole or in part) for its files; provided, however, that any such Confidential Information so retained shall be subject to the terms of this Agreement.

(b) Notwithstanding Section 9(a) above, (i) the Receiving Party and its Representatives shall not be obligated to return or destroy any Confidential Information that the Receiving Party is retaining pursuant to a document retention hold established in connection with any actual or anticipated civil or criminal investigation or litigation, in which event the Confidential Information shall be retained by the Receiving Party or its Representatives until such time as the document retention hold is no longer in effect, at which time the Confidential Information shall be returned to the Disclosing Party or destroyed as aforesaid; (ii) to the extent that the Receiving Party's or any of its Representative's computer back-up procedures create copies of the Confidential Information, the Receiving Party or such Representative may retain such copies in its archival or back-up computer storage for the period the Receiving Party or such Representative normally archives backed-up computer records; (iii) each of the Receiving Party and its Representatives may retain those materials containing the Disclosing Party's Confidential Information that are distributed to or created by its board of directors or senior management in connection with the Possible Transaction; and (iv) the Receiving Party and its affiliates shall not be required to return or destroy any filing or other document or material provided to, or document or material created or held by, any governmental authorities in connection with the Possible Transaction.

(c) Any Confidential Information not returned or destroyed pursuant to this Section 9 shall be retained subject to the terms this Agreement until it is returned, destroyed or erased.

10. Integration Clause. This Agreement embodies all of the understandings, and merges all other or prior agreements, understandings or arrangements between the Parties concerning the subject matter hereof.

11. Assignment. This Agreement may not be assigned by a Party without the other Party's prior written consent (which shall not be unreasonably withheld, delayed or conditioned), except by any Party in connection with the sale or bona fide transfer of all or substantially all of

the business or assets of the assigning Party, provided that the assignee agrees in writing to be bound by the terms and conditions hereof and promptly notifies the other Party in writing of such agreement. Upon any assignment made in compliance with this Section 11, this Agreement shall inure to and be binding upon each assignee of the assigning Party. All assignments in breach of this Agreement shall be null and void. [Bidder] acknowledges and agrees that ENOI is an express third-party beneficiary of this Agreement.

12. Equitable Relief. The Parties agree that the restrictions contained herein are fair and reasonable and necessary to protect the legitimate interests of the Disclosing Party, and that the Disclosing Party may suffer irreparable injury if the Receiving Party or any of its Representatives were to violate any provision of this Agreement. The Receiving Party acknowledges and agrees that, without prejudice to any other right and remedy available to the Disclosing Party at law or in equity, the Disclosing Party shall be entitled to (i) seek injunctive relief and specific performance of the terms hereunder and (ii) recover all reasonable costs and expenses, including, without limitation, reasonable attorneys' fees, expert witness fees and other out-of-pocket costs, from the Receiving Party if there is a breach or threatened breach of any of the provisions of this Agreement by the Receiving Party.

13. Governing Law; Jury Waiver. This Agreement, and all claims hereunder, shall be governed by and construed in accordance with the laws of the state of Texas, without giving effect to the principles of conflict of laws that would require or permit the application of the laws of any other jurisdiction. EACH PARTY HEREBY WAIVES ANY RIGHT TO HAVE A JURY PARTICIPATE IN RESOLVING ANY DISPUTE, WHETHER SOUNDING IN CONTRACT, TORT OR OTHERWISE, BETWEEN ANY OF THEM ARISING UNDER THIS AGREEMENT.

14. Multiple Counterparts. This Agreement may be executed in counterparts, each of which shall be deemed to be an original and all of which shall constitute one and the same document. Any executed counterpart transmitted by facsimile, electronic communication in portable document format (.pdf), or similar transmission by any Party shall be deemed an original and shall be binding upon such Party.

15. Amendments. No amendment, modification, waiver, or other change to this Agreement shall be enforceable, except as specifically provided for in this Agreement, unless reduced to writing and executed by both Parties (or with respect to a waiver, by the waiving Party).

16. Disclosure Rights. The Disclosing Party represents and warrants to the Receiving Party that it may disclose or make available all Confidential Information disclosed to the Receiving Party hereunder without violating or being in breach of any contractual, fiduciary, or other obligation of non-disclosure existing at the time of such disclosure. The Disclosing Party shall indemnify, defend and hold harmless the Receiving Party and its Representatives from and against, and shall pay to the Receiving Party and its Representatives the amount of, any and all reasonable out-of-pocket expenditures in respect of any and all losses, damages, liabilities, obligations, penalties, fines, charges, costs, expenses and disbursements (including interest payable as a part thereof, reasonable legal and accountants' fees and expenses relating thereto, and other out-of-pocket expenses incurred in investigating, preparing or settling any action, cause of action,

arbitration, claim, demand, suit or proceeding of any nature, in law or in equity, by or before any governmental authority or arbitrator) incurred by or assessed against the Receiving Party or its Representatives in respect of, resulting from, arising out of or caused by any third-party claims relating to any violation or breach of the representation and warranty made by the Disclosing Party in the preceding sentence.

17. No Waiver. Subject to applicable statutes of limitation, no failure or delay, in whole or in part, by the Disclosing Party in exercising any right or power hereunder shall operate as a waiver, full or partial, of such right or power.

18. No Joint Venture. This Agreement does not create and is not evidence of a joint venture, partnership, agency or other similar relationship between the Parties. The Parties acknowledge and agree that (i) they and their respective affiliates are involved in the same or similar businesses, (ii) subject to the express obligations of each Party set forth in this Agreement, nothing herein or otherwise will restrict either Party or its affiliates from competing with the other Party and its affiliates, (iii) there is no fiduciary relationship or other implied obligation of either Party or any of their affiliates to the other Party with respect to the subject matter hereof or based on any course of dealing, the Parties' respective obligations being solely those expressly set forth herein, and (iv) nothing in this Agreement creates any exclusive dealing arrangement between the Parties and their affiliates with respect to the Confidential Information.

19. Severability. The invalidity or unenforceability of any provision of this Agreement shall not affect the validity or enforceability of any other provision of this Agreement, which shall remain in full force and effect. Any unenforceable provision shall be deemed modified to the limited extent required to permit its enforcement in a manner most closely representing the intention of the Parties as expressed herein.

20. No Consequential or Punitive Damages. NEITHER PARTY SHALL BE LIABLE TO THE OTHER PARTY HEREUNDER FOR ANY SPECIAL, INDIRECT, INCIDENTAL, CONSEQUENTIAL, OR PUNITIVE DAMAGES OF ANY KIND OR CHARACTER, EXCEPT TO THE EXTENT THAT AN INDEMNIFYING PARTY, PURSUANT TO THE PROVISIONS OF SECTION 16 HEREOF, IS OBLIGATED TO INDEMNIFY AN INDEMNITEE AGAINST THIRD PARTY CLAIMS.

21. Notices. Any notice or other communications required or permitted to be given pursuant to this Agreement shall be confirmed in writing and shall be deemed properly given when hand delivered, sent by overnight mail service, mailed certified mail, return receipt requested, or transmitted by facsimile with date and sending Party identified to the following addresses:

If to ESI: Entergy Services, Inc.  
Attn: General Counsel  
639 Loyola Avenue, 26<sup>th</sup> floor  
New Orleans, LA 70113  
Facsimile number: (504) 576-2977

with a copy to:

Entergy Services, Inc.  
Attn: Timothy S. Cragin  
639 Loyola Avenue, 26<sup>th</sup> floor  
New Orleans, LA 70113  
Facsimile number: (504) 576-5579

If to [Bidder]:

[Bidder]  
Attn: [            ]  
[Address]  
[Address]  
Facsimile: [            ]

*[Signature page follows]*

IN WITNESS WHEREOF, the Parties have entered into this Agreement effective as of the Effective Date.

ENTERGY SERVICES, INC. .

By: \_\_\_\_\_  
Name: \_\_\_\_\_  
Title: \_\_\_\_\_

[BIDDER]

By: \_\_\_\_\_  
Name: \_\_\_\_\_  
Title: \_\_\_\_\_

PROPOSAL SUBMISSION AGREEMENT

THIS PROPOSAL SUBMISSION AGREEMENT (this “Agreement”) is made and entered into effective on \_\_\_\_\_, 2016 (the “Effective Date”), by \_\_\_\_\_, a \_\_\_\_\_ (“Bidder”), in favor of Entergy Services, Inc. (“ESI”).

**RECITALS**

WHEREAS, in response to ESI’s 2016 Request For Proposals For Long-Term Renewable Generation Resources For Entergy New Orleans, Inc., dated July 13, 2016 (as amended, supplemented, or otherwise modified, the “RFP”), Bidder is submitting and delivering to ESI (i) one or more Proposals (defined below) and (ii) this Agreement; and

WHEREAS, Bidder desires to continue to participate, and ESI desires to permit Bidder to continue to participate, in a competitive bidding process for the potential purchase of long-term renewable generation capacity and energy resources pursuant to the RFP (the “RFP Process”) on the terms and subject to the conditions set forth in this Agreement; and

WHEREAS, Bidder intends for the terms of this Agreement to be enforceable by ESI against Bidder;

**AGREEMENT**

NOW, THEREFORE, in consideration of the foregoing recitals and other good and valuable consideration, the receipt and sufficiency of which are hereby acknowledged, Bidder, by signing this Agreement below, hereby agrees as follows:

1. Definitions. Each of the following terms, when used with the initial letters capitalized in this Agreement, has the meaning ascribed to it below:

“Bidder Representative” means any officer, employee, agent, consultant, advisor, or representative of Bidder or any of Bidder’s affiliates. For the avoidance of doubt, for purposes of the RFP or the RFP Process, ESI is not, and shall not be considered, a Bidder Representative.

“Definitive Agreement” means a legally binding agreement, mutually executed and delivered by duly authorized representatives of ESI or Entergy New Orleans, Inc. (“ENOI”) and Bidder (or the seller under the proposal submitted by Bidder that is the basis of such agreement), setting forth the definitive terms and conditions of a Transaction. For the avoidance of doubt, a “Definitive Agreement” does not include a letter of intent, memorandum of understanding, other similar preliminary written agreement or document with respect to a Transaction, or any acceptance, written, oral or other, of any offer or proposal submitted by Bidder (or the seller pursuant to or in connection with the Proposal).

“ESI Representative” means any officer, employee, agent, affiliate, consultant, advisor, or representative of ESI.



“FERC” means the Federal Energy Regulatory Commission, or any successor thereto.

“Law” means any statute, law, rule, regulation, ordinance, code, or other applicable legislative or administrative action of any governmental authority, or any judicial, regulatory, or administrative interpretation thereof having the force or effect of the foregoing, in each case as applicable to or binding upon the affected person or entity or any of its properties or to which such person or entity or any of its property is subject.

“Proposal” means an offer to enter into a Transaction that is submitted (or to be submitted) by Bidder pursuant to the RFP.

“RFP Administrator” means the administrator of the RFP set forth in Section 1.5 of the main body of the RFP.

“Term Sheets” means the term sheets that set forth some of the key commercial terms that would apply to any Transaction arising out of the RFP. The Term Sheets are available on the website for the RFP,

<https://spofossil.entropy.com/ENTRFP/SEND/2016ENOIREnewableRFP/Index.htm>

“Transaction” means a commercial transaction arising or resulting from the RFP in which Bidder (or the seller under the proposal submitted by Bidder that is the basis of such agreement) provides to ENOI capacity, capacity-related benefits, energy, other electric products, and environmental attributes from a specified generation resource pursuant to a Definitive Agreement and that is structured as a power purchase agreement or a purchase and sale of such generation resource.

Terms not defined in this Section 1 but defined elsewhere in this Agreement have the corresponding meanings given to such terms elsewhere in this Agreement.

2. Certain Bidder Representations, Warranties, and Covenants. Bidder represents and warrants and, as applicable, covenants to ESI as follows:

(a) Bidder has all requisite power and authority to execute and deliver this Agreement and perform its obligations hereunder. The execution, delivery, and performance of this Agreement by Bidder have been duly authorized by all necessary action on the part of Bidder and do not violate, conflict with, or result in a breach of any provision of its organizational or governing documents. This Agreement constitutes a legally valid and binding obligation enforceable against Bidder in accordance with its terms, except as such enforceability may be limited by bankruptcy, insolvency, reorganization, moratorium, or other similar laws relating to creditors’ rights generally or general principles of equity (whether considered in a proceeding at law or in equity). Bidder is acting for its own account, has made its own independent decision to enter into this Agreement and as to whether this Agreement is appropriate or proper for it based upon its own judgment, has had complete discretion in seeking and obtaining the advice and counsel of experts relating to specialized subject matter of this Agreement, and is capable of assessing the merits of and understanding, and understands and accepts, the terms, conditions, and risks of this Agreement.

(b) The execution and delivery of each Proposal by Bidder have been duly authorized by all necessary action on the part of Bidder. Each Proposal has been executed and delivered by a duly authorized officer or other authorized representative of Bidder. By submitting a Proposal, Bidder is offering to enter into a Definitive Agreement providing for the Transaction contemplated by such Proposal on substantially the same terms and conditions set forth in such Proposal and the Term Sheet corresponding to such Proposal and made available to Bidders on the website for the RFP,

<https://spofossil.entergy.com/ENTRFP/SEND/2016ENOIREnewableRFP/Index.htm>. Each Proposal submitted by Bidder is Bidder's good faith best offer. Bidder has reviewed and is familiar with the terms and conditions of the RFP, including the Term Sheets. With respect to any Proposal selected by ESI for possible negotiation of a Definitive Agreement, Bidder agrees to enter into good faith negotiations with ESI to finalize, and shall use reasonable best efforts (or do, or cause to be done, all things necessary or appropriate) to finalize, execute, and deliver a Definitive Agreement providing for the Transaction contemplated by such Proposal on substantially the same terms and conditions set forth in such Proposal.

(c) Bidder has not disclosed and no Bidder Representative has disclosed (and Bidder covenants that neither it nor any Bidder Representative will disclose) to any other Bidder or potential Bidder in the RFP Process (i) the fact that Bidder is participating in the RFP Process, provided that the attendance by Bidder or a Bidder Representative at any meeting organized by ESI and to which ESI invites one or more Bidders or potential Bidders in connection with the RFP is not a disclosure that violates the terms of this Agreement or a basis for a claim that Bidder's representation in clause (i) immediately above is false or inaccurate or that Bidder has breached its covenant in such clause, or (ii) the existence of, or the price or any other term or condition of, any Proposal or any other submission of Bidder to ESI or any ESI Representative in connection with the RFP Process. Notwithstanding the foregoing, the above Bidder covenant shall not apply with respect to any information described in clause (i) or (ii) that has entered the public domain through no failure of Bidder or Bidder's Representatives to comply with the terms hereof or any other agreement to which Bidder or a Bidder's Representative is party or by which Bidder or a Bidder's Representative is bound.

(d) To the knowledge of each Bidder Representative who has actually participated in the preparation of a Proposal on behalf of Bidder, there is no uncured violation by Bidder of applicable state or federal antitrust Laws or other applicable Laws that pertain to competitive bidding practices in connection with such Proposal.

(e) Bidder has not entered into, and covenants that it will not enter into, any understanding, agreement, plan, arrangement, or scheme pertaining to a Proposal, whether express or implied, formal or informal, oral or written, with any competitor of Bidder with respect to prices, terms, or conditions of sale, output, production, distribution, territories, or customers, which understanding, agreement, plan, arrangement, or scheme would be in violation of applicable Law.

3. ESI Disclaimer. Bidder understands, acknowledges, and agrees that (i) except as may be expressly provided in a Definitive Agreement, any and all material and information furnished by or on behalf of ESI in connection with the RFP Process, including, without limitation, information contained in the RFP, is being or will be provided without any representation or warranty of any kind or character as to the material or information so provided, including, without limitation, accuracy or completeness; (ii) except as otherwise provided in Section 4 below, neither ESI nor any ESI Representative shall have any liability to Bidder or any Bidder Representative relating to or arising from the use of or reliance upon any such information or any error or omission therein or otherwise in connection with the RFP Process; and (iii) the material, information and processes described by ESI in the RFP or otherwise provided by either ESI or ESI Representative in connection with the RFP Process are merely statements or indications of ESI's current intent, and such statements or indications create no binding obligation or actionable promise or inducement on the part of ESI or ESI Representative.

4. ESI Obligations Limited To Definitive Agreement. Bidder understands, acknowledges, and agrees that no enforceable contract or agreement providing for or promising a Transaction shall be deemed to exist or shall be enforceable against ESI or any ESI Representative unless and until a Definitive Agreement for such Transaction has been executed and delivered by authorized representatives of ESI and Bidder (or other authorized seller). Bidder also understands, acknowledges, and agrees that (i) unless and until a Definitive Agreement between ESI and Bidder (or other authorized seller) with respect to a Transaction has been executed and delivered, neither ESI nor any ESI Representative has or shall have any legal obligation to Bidder of any kind whatsoever with respect to such Transaction, whether by virtue of this Agreement, the RFP, or any other written, electronic, or oral expression with respect to the RFP Process or such Transaction, and (ii) if a Definitive Agreement between ESI and Bidder (or other authorized seller) with respect to a Transaction has been executed and delivered, the only legal obligations of ESI with respect to such Transaction shall be those expressly set forth in the terms and conditions of such Definitive Agreement and applicable Law.

5. ESI RFP Process Discretion. Bidder understands, acknowledges, and agrees that, subject to applicable Laws, (i) ESI shall be free to conduct the process for any Transaction, including, without limitation, the RFP Process, as ESI determines in its sole and absolute discretion, (ii) the RFP and any procedures relating to the RFP Process may be changed at any time without notice to Bidder or any other person, and (iii) the provisions of Appendix E (Reservation of ESI Rights and Other RFP Terms) of the RFP (available to Bidder on the RFP website (the link to which is provided in Section 1 above, in the definition of Term Sheets) apply to, are accepted by, and are enforceable against Bidder, and such provisions are incorporated herein by reference. Except in a proceeding before FERC, the Council of the City of New Orleans, or a court described in Section 10 below, Bidder shall not assert, and hereby knowingly, voluntarily, and unconditionally forever waives and disclaims any right to assert, in any regulatory or judicial forum, any claim or complaint, and any and all rights derivative or arising out of any such claim or complaint, regarding or related to the conduct or result of the RFP Process.

6. Bidder Qualifications. Bidder has previously provided, or is providing as part of its Proposal(s), or from time to time after Bidder's execution of this Agreement may provide, to ESI certain information with respect to Bidder's qualifications to participate in the RFP Process.

Bidder represents and warrants to ESI that all such information that Bidder has previously provided or is providing in its Proposal(s) is true and accurate as of the Effective Date and that any such information Bidder may hereafter provide concerning its Proposal(s) will be true and accurate as of the date Bidder provides it to ESI. Bidder agrees that, so long as Bidder continues to participate in the RFP Process and the applicable RFP document(s) do not otherwise provide, Bidder will promptly inform ESI of any material change in any of the information provided by Bidder regarding Bidder's qualifications to participate in the RFP Process and will promptly provide ESI with subsequently filed or prepared information (including, without limitation, any financial statements and reports) of the type previously provided or contemplated.

7. Bidder Indemnification. Bidder shall defend, indemnify, and hold harmless ESI, each of its parents and other affiliates, and each of their respective officers, directors, employees, attorneys, agents, and successors and assigns, upon demand, from and against any and all demands, suits, penalties, obligations, damages, claims, losses, liabilities, judgments, payments, costs, and expenses (including reasonable legal, accounting, and other fees and expenses in connection therewith and costs and expenses incurred in connection with investigations and settlement proceedings), which arise out of, are in connection with, or relate to (i) any breach or violation of any covenant, obligation, or agreement of Bidder set forth in this Agreement or (ii) any breach or inaccuracy of any of the representations or warranties of Bidder in this Agreement.

8. Waivers. Without limiting Section 14 below, no provision of this Agreement may be waived except by ESI and except as and to the extent set forth in a writing signed by an authorized representative of ESI and designated as a waiver. Any waiver by ESI of its rights, duties, and/or obligations with respect to any default under this Agreement, or with respect to any other matter arising out of or in connection with this Agreement, shall not be deemed a continuing waiver, nor a waiver with respect to any prior or subsequent default or other matter and shall be limited to its express terms. Any delay in asserting or enforcing any right under this Agreement shall not be deemed a waiver of such rights. A failure of ESI to enforce any provision of this Agreement or to require performance by Bidder of any of the provisions hereof shall not be construed to waive such provision, or to affect the validity of this Agreement or any part thereof, or the right of ESI thereafter to enforce each and every provision hereof.

9. Assignment; Successors and Assigns. This Agreement and all of the rights, benefits, powers, privileges, duties, or obligations hereunder may be assigned by ESI, without prior notice to Bidder or Bidder's consent, to any of its affiliates or to any party or parties that merge with, acquire an ownership interest in, or succeeds to all or substantially all of the assets of ESI, its assets, businesses, or any material part thereof. None of this Agreement or any right, benefit, power, privilege, duty, or obligation of Bidder hereunder may be assigned or otherwise transferred by Bidder without ESI's prior written consent, which may be granted or withheld in ESI's sole and absolute discretion. Any purported assignment or other transfer by Bidder in violation of this Section 9 shall be void *ab initio* and of no effect. This Agreement shall be binding upon Bidder and the successors and permitted assigns of Bidder.

10. Governing Law; Jurisdiction and Venue; Waiver of Jury Trial. This Agreement shall be governed in all respects, whether as to validity, construction, capacity, performance, or otherwise, by and under the laws of the State of Louisiana (without giving effect to principles of

conflicts of laws). Bidder hereby irrevocably consents to the non-exclusive personal jurisdiction and venue of any Louisiana or United States Federal court of competent jurisdiction sitting in Orleans Parish, Louisiana, in any action, claim, or proceeding arising out of or in connection with this Agreement. BIDDER HEREBY EXPRESSLY AND IRREVOCABLY WAIVES AND AGREES NOT TO ASSERT (I) THE DEFENSE OF LACK OF PERSONAL JURISDICTION, *FORUM NON CONVENIENS* OR ANY SIMILAR DEFENSE WITH RESPECT TO THE MAINTENANCE OF ANY SUCH ACTION, CLAIM, OR PROCEEDING IN ORLEANS PARISH, LOUISIANA, AND (II) THE RIGHT TO TRIAL BY JURY IN ANY SUCH ACTION OR PROCEEDING.

11. Liability for Bidder Representatives. Bidder shall ensure that each Bidder Representative is informed of the terms of this Agreement and that each such person adheres to this Agreement as it applies to Bidder as if such person were a party hereto. Bidder shall be responsible for any breach of this Agreement resulting from or arising out of the acts or omissions of any Bidder Representative.

12. Severability. All provisions of this Agreement are severable. In the event that any provision of this Agreement is held to be invalid or unenforceable, such provision shall be (i) invalid or unenforceable only to the extent of such invalidity or unenforceability without invalidating or rendering unenforceable any other provision hereof and (ii) revised or reformed, to the maximum extent permitted under applicable Law, in a manner resulting in rights, duties and obligations most closely representing the intention of Bidder and ESI, as agent, as expressed herein.

13. Term. The term of this Agreement shall commence on the date hereof and shall continue in effect until the last to occur of (i) the completion of the RFP Process, (ii) the conclusion of any regulatory proceedings or litigation relating to the RFP Process, the Proposal, or this Agreement, or (iii) six (6) years from the Effective Date.

14. Integration. This Agreement contains the entire agreement between ESI and Bidder with respect to the subject matter hereof and supersedes all prior understandings, agreements and writings between them with respect to the subject matter hereof, whether written or oral, save and except for any written agreement with respect to confidentiality obligations and Bidder Registration. This Agreement may not be altered, amended, modified, or otherwise changed by any prior, contemporaneous, or subsequent agreements, understandings, discussions or course of dealings unless the same is reduced to a writing that specifically refers to this Agreement and is signed by authorized representatives of Bidder and ESI. This Agreement may be executed physically in one or more counterparts, each of which is an original, but all of which together constitute one and the same instrument.

15. Enforceability; Reliance. Bidder acknowledges and agrees that, notwithstanding anything to the contrary herein or elsewhere, Bidder intends for this Agreement to be, and this Agreement shall be, fully enforceable in all respects by ESI against Bidder, and ESI or ESI Representatives (as applicable) shall be considered the sole beneficiaries of this Agreement. Bidder hereby waives and disclaims any legal or equitable defense to any claim made by or on behalf of ESI or any ESI Representative in connection with this Agreement or the RFP based on

or otherwise arising out of ESI or any ESI Representative not being a signatory to this Agreement. The obligations, waivers, disclaimers, and terms of Sections 2 through 15 herein are fundamental to this Agreement, and ESI's decisions to allow Bidder to continue to participate in this RFP and enter into this Agreement are made in express reliance on such obligations, waivers, and disclaimers.

IN WITNESS WHEREOF, Bidder has executed this Agreement as of the Effective Date and in the manner first written above.

Bidder ID: \_\_\_\_\_

Resource ID: \_\_\_\_\_

Proposal ID: \_\_\_\_\_

Bidder Name: \_\_\_\_\_

By: \_\_\_\_\_

Name: \_\_\_\_\_

Title: \_\_\_\_\_

2016 ENOI Renewables RFP - SELF-ASSESSMENT FORM FOR EXISTING RESOURCES		
Assessment Criteria	Bidder Response	Bidder Comments
<b>Bidder ID</b>		
<b>Resource ID</b>		
<b>Proposal ID</b>		
<b><u>Resource Overview</u></b>		
Commercial Operation Date		
Guaranteed Contract Start Date		
Other Sales Commitments from Resource? (Term and Contract Quantity)		
Physical Configuration (# of turbines, inverters, panels, etc)		
Technology and Equipment (including Turbine Manufacturer)		
Other Major Equipment Manufacturer (e.g. turbine towers and blades at wind facility, inverters for solar, etc.)		
Typical Unit Operation Role		
Dependable Capacity Offered - ICAP (MW)		
Recognized Capacity Offered - UCAP (MW)		
Current Capacity Amount Recognized (UCAP) by RTO		
Physical Point of Delivery		
Physical Resource Location (Substation)		
Product Type Offered		
PPA, Delivery Term		
Resource Type (If Solar PV, Fixed Tilt or Tracking?)		
(If Solar PV) AC and DC rating		
Has the Bidder provided actual historical production data since COD?		
How many projects of the proposed technology in the proposed configuration have been installed worldwide?		
How many MWs of the proposed technology in the proposed configuration have been installed worldwide?		
Solar Panel Degradation (Annual %)		
<b><u>Operations &amp; Maintenance</u></b>		
Has a list of O&M and timeline (if applicable) of entities been provided?		
Is an LTSA or Maintenance Program in place?		

Is the operating range flexible?		
Have unit characteristics been provided?		
Any significant component replacement(s) made?		
Have historical service hours been provided?		
<b><u>Commercial</u></b>		
Is the proposal based on an Eligible Resource?		
Has Bidder proposal taken exceptions to the term sheet(s)?		
(PPA) Is the Physical Delivery Point MISO South (LRZ 8, 9 & 10)? (Specify Location)		
(Acquisition) Is the Physical Delivery Point ENOI Load Zone? (Specify Location)		
Is the Financial Delivery point the EES.NOPLD Commercial Pricing Node ?		
For Resources Outside the ENOI Load Zone, Does Bidder agree to take responsibility for financial settlement, including basis differential and congestion costs/risks from the CP Node at the Electric Interconnection Point to the Buyer Load Node?		
Does Bidder's Proposal trigger a VIE structure or lease treatment?		
<b><u>Environmental</u></b>		
Are all operational and construction permits currently in effect?		



2016 ENOI Renewables RFP - SELF-ASSESSMENT FORM FOR DEVELOPMENTAL RESOURCES		
Assessment Criteria	Bidder Response	Bidder Comments
<b>Bidder ID</b>		
<b>Resource ID</b>		
<b>Proposal ID</b>		
<b><u>Resource Overview</u></b>		
Expected Commercial Operation Date		
Guaranteed Commercial Operation Date		
Guaranteed Contract Start Date		
Other Sales Commitments from Resource? (Term and Contract Quantity)		
Physical Configuration (# of turbines, inverters, panels, etc)		
Technology and Equipment (including Turbine Manufacturer)		
Other Major Equipment Manufacturer (e.g. turbine towers and blades at wind facility, inverters for solar, etc.)		
Typical Unit Operation Role		
Expected Dependable Capacity Offered - ICAP (MW)		
Expected Recognized Capacity Offered - UCAP (MW)		
Physical Delivery Point (if aggregated PV, include feeder number for each location)		
Physical Resource Location (County and nearest substation; list all for aggregated PV)		
Product Type Offered		
PPA, Delivery Term		
Resource Type (If Solar PV, Fixed Tilt or Tracking?)		
(If Solar PV) AC and DC rating		
(If Acquisition) Have any ITC effects and/or pricing been excluded from proposal?		
(If PPA) Have any ITC/PTC effects and/or pricing been included in proposal?		
<b><u>Technical Feasibility</u></b>		
Is the proposal based on proven technology (operating history and financeable)?		
Has the Bidder provided 2 years of onsite/near site profile data? Specify location and distance from proposed project site.		
What is the source of the production profile data?		
First year expected generation amount from generation profile data (MWh)		





**BEFORE THE  
COUNCIL OF THE CITY OF NEW ORLEANS**

**APPLICATION OF ENTERGY NEW )  
ORLEANS, INC. FOR APPROVAL TO )  
CONSTRUCT DISTRIBUTED GENERATION- )  
SCALE SOLAR PHOTOVOLTAIC SYSTEMS ) DOCKET NO. UD-17-\_\_  
AND REQUEST FOR COST RECOVERY AND )  
RELATED RELIEF )**

**EXHIBIT SEC-4**

**HIGHLY SENSITIVE  
PROTECTED MATERIAL**

**INTENTIONALLY OMITTED**

**OCTOBER 2017**



# Update on ENO's 2016 Renewables RFP



CNO Docket No. UD-17-  
Page 1 of 11

Exhibit SEC-5



## ENO Seeks to Add Renewable Energy Resources to its Generation Portfolio

- ENO's 2015 Integrated Resource Plan ("IRP") identified that solar costs were trending lower and indicated that a Request for Proposals ("RFP") for renewable energy resources would be issued
- ENO issued an RFP targeting up to 20 MW of renewables
- Following issuance of the RFP, ENO committed to pursue up to 100 MW of renewable resources
- In furtherance of that commitment, three projects were selected from the RFP, totaling ~45 MW, including 2 projects located in Orleans Parish
- ENO has begun planning efforts to add up to ~55 MW of additional renewables



# Key RFP Milestones for Selected Renewable Projects

RFP Milestones	Completed
Public Notice	✓
Draft RFP Posted	✓
RFP Public Bidder Conference	✓
Public Bidder Comments and Q&A	✓
Final RFP Posted	✓
Supplemental Bidder Q&A	✓
Proposals Received	✓
Selections Announced	✓
Contracts/Letter of Intent Circulated	✓
Contracts Executed	
Regulatory Approvals & Other Contract Conditions	

# PPA Transaction Summary and Target Timeline

- Resource: Solar PV (transmission-connected, ground-mounted, single axis tracking)
- Size: 20 MW
- Transaction Type: Power Purchase Agreement (PPA)
- Location: Outside of Orleans Parish
- Status: In contract negotiations
  - 6/16/17: Draft PPA Delivered to Developer
  - 7/21/17: Developer's Comments and Mark Up Received
- Next Steps:
  - Pending completion of negotiations, execution of the PPA
  - Target regulatory filing: Q1 2018; the target date is aspirational and subject to change



**Illustrative Tracking Solar Project**

CIND Docket No. UD-17-  
Page 4 of 11

Exhibit SEC-5



## Build-Transfer Transaction Summary and Target Timeline

- Resource: Solar PV (transmission-connected, ground-mounted, fixed-tilt)
- Size: 20 MW
- Transaction Type: Build-Transfer
- Location: Orleans Parish
- Status: In contract negotiations
  - 6/16/17: Interconnection and Structure Determined by Developer
  - 7/3/17: Letter of Intent Delivered to Developer
- Next Steps:
  - Pending completion of negotiations, execution of the Purchase Agreement
  - Target regulatory filing: Q3 2018; the target date is aspirational and subject to change



Illustrative Fixed-Tilt Solar Panel

## Aggregated Rooftop Solar PV Project and Target Timeline

- Resource: Solar PV (distribution-connected, rooftop, fixed-tilt)
- Size: ~ 5 MW
- Transaction Type: Self-Build
- Location: Orleans Parish, multiple sites in the 100 kW to 1-2 MW range
- Status: Finalizing engineering, procurement, and construction (EPC) agreement
- Next Steps:
  - Execution of EPC agreement
  - Target regulatory filing: Q4 2017; the target date is aspirational and subject to change



**Illustrative Rooftop Solar Project**

# APPENDIX



## Suniva Trade Complaint Creates Potential Risks for Solar projects



- Georgia-based solar panel company that filed for bankruptcy in April 2017
- Suniva filed a trade complaint under Section 201 of the Trade Act of 1974 to the International Trade Commission (ITC)
- Complaint asks for duties on cells of \$0.40/Watt and a price floor on modules of \$0.78/Watt
- Industry estimates ~47 GW of impacted solar installations, and it could cost 88,000 solar industry jobs
- ITC decision is expected by the end of the year
- Even if the ITC does not find in Suniva's favor, the law provides President Trump the ability to impose new tariffs (at any level)

Source: <https://www.greentechmedia.com/articles/read/suniva-dispute-could-halt-two-thirds-of-us-solar-installations>

# Potential Benefits of Aggregated Rooftop Solar PV Projects

- Real-world experience with distributed-scale solar PV
- Influence over siting
- Clear visibility into operations
- Ability to add energy storage in the future as economics improve
- Avoid time and cost of transmission-level interconnection
- Ability to partner with customer host sites to create win-win outcomes
- Increased local investment and use of local labor & services
- Visibly support renewables in and around New Orleans



# Entergy New Orleans Solar Power Plant

- ~1.3 MW<sub>DC</sub> (~1.1 MW<sub>AC</sub>) single-axis tracker mounted panels
- 500 kW one-hour advanced Li-ion battery
- Project operational as of June 2016
- Near former site of a gas-fired peaking unit destroyed by Hurricane Katrina



# Entergy New Orleans Solar Power Plant

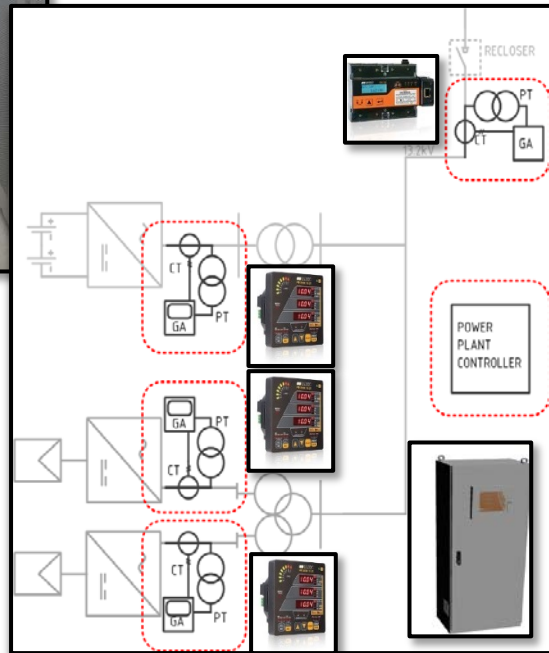

**BEFORE THE  
COUNCIL OF THE CITY OF NEW ORLEANS**

**APPLICATION OF ENTERGY NEW ORLEANS, INC. )  
FOR APPROVAL TO CONSTRUCT DISTRIBUTED )  
GENERATION-SCALE SOLAR PHOTOVOLTAIC ) DOCKET NO. UD-17-\_\_  
SYSTEMS AND REQUEST FOR COST RECOVERY )  
AND RELATED RELIEF )**

**EXHIBIT SEC-6**

**HIGHLY SENSITIVE  
PROTECTED MATERIAL  
INTENTIONALLY OMITTED**

**OCTOBER 2017**



**BEFORE THE  
COUNCIL OF THE CITY OF NEW ORLEANS**

**APPLICATION OF ENTERGY NEW )  
ORLEANS, INC. FOR APPROVAL TO )  
CONSTRUCT DISTRIBUTED )  
GENERATION-SCALE SOLAR )  
PHOTOVOLTAIC SYSTEMS AND )  
REQUEST FOR COST RECOVERY )  
AND RELATED RELIEF )**

**DOCKET NO. UD-17-\_\_**

**DIRECT TESTIMONY**

**OF**

**ORLANDO TODD**

**ON BEHALF OF**

**ENTERGY NEW ORLEANS, INC.**

**PUBLIC VERSION**

**OCTOBER 2017**

**Table of Contents**

I. INTRODUCTION .....1  
II. PROJECT INVESTMENT REVENUE REQUIREMENT .....2  
III. REQUESTED COST RECOVERY .....7

**EXHIBIT LIST**

Exhibit OT-1 Listing of Prior Testimony  
Exhibit OT-2 Estimated Revenue Requirement (Highly Sensitive Protected Material  
("HSPM")) (on CD)

**I. INTRODUCTION**

1  
2 Q1. PLEASE STATE YOUR NAME, TITLE AND CURRENT BUSINESS ADDRESS.

3 A. My name is Orlando Todd. My business address is 1600 Perdido Street, New Orleans,  
4 Louisiana 70112. I am employed by Entergy Services, Inc. (“ESI”),<sup>1</sup> as Finance Director  
5 for Entergy New Orleans, Inc. (“ENO” or the “Company”).

6  
7 Q2. WHAT ARE YOUR CURRENT DUTIES?

8 A. I am responsible for financial management, financial planning and monitoring, and  
9 assisting in the resolution of regulatory issues for ENO.

10

11 Q3. ON WHOSE BEHALF ARE YOU TESTIFYING IN THIS PROCEEDING?

12 A. I am testifying in this proceeding before the Council of the City of New Orleans (“CNO”  
13 or the “Council”) on behalf of ENO.

14

15 Q4. PLEASE DESCRIBE YOUR EDUCATIONAL BACKGROUND AND  
16 PROFESSIONAL EXPERIENCE.

17 A. I have a B.B.A. in Accounting from Southern Arkansas University and an M.B.A. from  
18 the University of Arkansas - Little Rock. I am a Certified Public Accountant. I began my  
19 career with Entergy Corporation and its subsidiaries in 1983. I started in Property  
20 Accounting and have worked in other departments, including General Accounting,

---

<sup>1</sup> ESI is a subsidiary of Entergy Corporation that provides technical and administrative services to all of the Operating Companies. The Entergy Operating Companies include Entergy Arkansas, Inc.; Entergy Louisiana, LLC; Entergy Mississippi, Inc.; Entergy New Orleans, Inc.; and Entergy Texas, Inc.

1 Finance Operations Center, and Corporate Reporting. Prior to my career with the Entergy  
2 System, I worked for Price Waterhouse (now known as PricewaterhouseCoopers).

3

4 Q5. HAVE YOU TESTIFIED PREVIOUSLY BEFORE THE CITY COUNCIL?

5 A. Yes. Please see attached ENO Exhibit OT-1.

6

7 Q6. WHAT IS THE PURPOSE OF YOUR TESTIMONY?

8 A. I am testifying in support of the Company's Application, which seeks approval of its plan  
9 to construct distributed generation ("DG")-scale solar photovoltaic ("PV") systems (the  
10 "Project") within ENO's service area. I also support the Company's proposal to reflect  
11 the costs and benefits of the Project in electric rates.

12

13 **II. PROJECT INVESTMENT REVENUE REQUIREMENT**

14 Q7. PLEASE DESCRIBE THE PROPOSED INVESTMENT.

15 A. As described in detail in the Direct Testimony of Company witness D. Andrew Owens,  
16 ENO is proposing to construct approximately 5 MW<sub>AC</sub> of DG-scale solar PV systems that  
17 will be located at multiple sites within Orleans Parish. The majority of the Project's cost  
18 will come through an Engineering, Procurement & Construction ("EPC") agreement that  
19 has been executed with Brightergy Louisiana, LLC. The remaining cost involves ENO  
20 and ESI labor and expenses, indirect costs including overheads, directly-assignable costs  
21 for interconnections to ENO's distribution system, Allowance for Funds Used During  
22 Construction ("AFUDC"), and contingency.

1           The total cost of the project is estimated to be approximately \$14.8 million, which  
2 includes the following breakdown by category. Mr. Owens provides more detail  
3 regarding the Project costs in his Direct Testimony.

Equipment (modules, inverters, racking, electrical interconnect, and balance of system (BOS) equipment)	
Installation labor	
Professional services (engineering, project management, leasing, corporate overheads, contingency, and fee)	
Miscellaneous (sales tax and performance bond)	
<b>EPC Agreement Sub-Total</b>	<b>\$12.29m</b>
Internal labor, expenses, indirect costs, and interconnections	\$1.31m
AFUDC	\$0.49m
Contingency	\$0.75m
Total estimated project cost	<b>\$14.84m</b>

4

5 Q8. ARE THERE OTHER COSTS ASSOCIATED WITH THE PROJECT?

6 A. Yes. There will be three additional on-going costs associated with the Project once the  
7 solar PV systems have been constructed, tested, and turned over to ENO. First, ENO will  
8 have entered into a long-term lease agreement with each property owner to secure the site  
9 (or sites) prior to installation of the DG-scale solar PV system. As described further by  
10 Mr. Owens in his Direct Testimony, each lease agreement will be negotiated with the  
11 property owner and the terms and conditions (including the amount, timing and form of  
12 lease payment) will be specific to each agreement. Second, there will be long-term  
13 operations and maintenance (“O&M”) costs associated with monitoring, routine  
14 inspection, periodic cleaning, and preventative equipment maintenance. Finally, ENO  
15 will incur additional property tax associated with the capital investment as reflected on its  
16 books.

1 Q9. PLEASE DISCUSS HOW THE PROJECT'S FIRST YEAR REVENUE  
2 REQUIREMENT IS CALCULATED.

3 A. The first year revenue requirement consists of two main components. The first  
4 component includes the various operating expenses described above that will be incurred  
5 during the first year of operation. Given that lease agreements have not yet been  
6 negotiated and executed with customers for use of their site(s), I am using the current  
7 planning assumption discussed in the Direct Testimony of Mr. Owens of [REDACTED]  
8 [REDACTED] spread across multiple sites to estimate the first-year revenue requirement. Also  
9 based on Mr. Owens' Direct Testimony, I have used an estimated fixed O&M cost of  
10 [REDACTED] in order to develop estimated fixed monitoring and  
11 operating costs for the first year of operation, not including the separate leasing payments.  
12 As Mr. Owens notes, the O&M cost estimate is also a planning assumption because ENO  
13 has not yet determined whether it will self-provide monitoring and O&M services or  
14 contract those tasks out to a third-party provider.

15 Finally, operating expenses include annual property taxes of \$379,000, as shown  
16 on the second page of HSPM Exhibit OT-2, resulting from ENO's capital investment in  
17 the Project. ENO will attempt to secure some level of property tax abatement for the  
18 Project under the state's industrial tax exemption program in order to minimize property  
19 tax costs. However, due to recent changes to the program (Governor's Executive Orders  
20 JBE 16-26 and JBE 16-73), any level of tax abatement requires the support and formal  
21 approval of the Council, the Orleans Parish School Board, and the Orleans Parish Sheriff's  
22 Office to obtain the state's approval of the exemption.

1           The second component of the revenue requirement is the return of and on rate  
2           base. A calculation of the rate base for the Project is necessary to determine the return of  
3           and on that rate base. The calculation of rate base for the Project is shown in HSPM  
4           Exhibit OT-2.

5  
6   Q10. PLEASE EXPLAIN HOW THE RATE BASE FOR THE PROJECT WAS  
7       CALCULATED.

8   A.   The calculation of the rate base for the Project begins with the projected total installed  
9       cost of \$14.84 million. This cost, or plant in service, represents the rate base on the first  
10       day of ownership by ENO, which is assumed to be January 1, 2019. During the first year  
11       of operation, there are no currently planned capital additions. Depreciation and  
12       amortization expense in the first year of ownership is estimated to be \$0.594 million,  
13       which is based on a 4% depreciation rate using an estimated 25-year asset life. Company  
14       witness Mr. Owens explains the appropriateness of using a 25-year asset life. As shown  
15       on page 1 of HSPM Exhibit OT-2, this expense increases the reserve for depreciation and  
16       amortization in the same amount and is a reduction to rate base in the first year of  
17       ownership of the newly constructed solar PV systems.

18           The final component of rate base is accumulated deferred income taxes, which  
19       represents the tax effect of the timing differences between book and tax depreciation as  
20       well as bonus depreciation, if available. Generally, the accumulated deferred income  
21       taxes are also a reduction to rate base. The end result of these calculations is a total rate  
22       base of \$11.920 million at the end of the first year of ownership, as shown in detail on  
23       page 1 of HSPM Exhibit OT-2.

1  
2  
3  
4  
5  
6  
7  
8  
9  
10  
11  
12  
13  
14  
15  
16  
17  
18  
19  
20  
21  
22  
23

Q11. PLEASE EXPLAIN HOW THE RETURN OF AND ON CAPITAL FOR THE PROJECT WAS CALCULATED.

A. The return on capital (rate base) is based on the pre-tax rate of return calculated on page 3 of HSPM Exhibit OT-2 multiplied by the rate base shown on page 1 of HSPM Exhibit OT-2. The pre-tax rate of return is based on capitalization ratios and cost rates of capital at December 31, 2016, which assumes a common equity ratio of 50% including the current City Council-authorized 11.10% return on equity. The return of capital, or depreciation expense, is based on the proposed 4% per year rate consistent with an estimated 25-year asset life. As noted above, the depreciation and amortization expense in the first year of ownership is estimated to be \$594,000.

As shown on page 2 of HSPM Exhibit OT-2, the total first year revenue requirement is equal to the sum of the annual operating costs and the return of and return on rate base or \$2.572 million annually.

Q12. PLEASE EXPLAIN HOW TAX BENEFITS ASSOCIATED WITH THE PROJECT INCLUDING THE 30% FEDERAL INVESTMENT TAX CREDIT (“ITC”) WOULD BE HANDLED.

A. There are three tax-related benefits incorporated into the first-year revenue requirement illustrated in HSPM Exhibit OT-2. These are accelerated depreciation, bonus depreciation, and the 30% Federal ITC. As discussed above, the return on the rate base associated with the Project will be based on the rate base in service as of the end of the test year period adjusted for any costs expected to be incurred within the rate effective



1 period. This amount will then be offset by the corresponding accumulated reserve for  
2 depreciation balance for the same period. Assuming that it is still available at the time the  
3 various solar PV systems come on-line and are reflected on the Company's books.

4 It is my understanding that per Internal Revenue Service ("IRS") rules, ENO is  
5 required to normalize the 30% Federal ITC. Under the IRS normalization rules, the tax  
6 benefit would be "flowed back" to ENO's retail electric customers on a ratable basis over  
7 time. Per the IRS normalization rules, the ITC has to be used on the consolidated income  
8 tax return before the ITC can be reflected in rates. Given a variety of factors, it may be a  
9 few years before the ITC amount that is tied to the Project can be normalized and reflected  
10 in ENO's retail rates.

11  
12 **III. REQUESTED COST RECOVERY**

13 Q13. HOW DOES ENO PROPOSE TO RECOVER ITS UPFRONT INVESTMENT AND  
14 ON-GOING COSTS AFTER THE PROJECT IS COMPLETED AND THE SOLAR PV  
15 SYSTEMS ARE OPERATIONAL?

16 A. The Company currently expects to file its next general base rate case sometime before  
17 July 31, 2018, as required in Council Resolution R-17-504 . As such, the Company will  
18 propose the recovery of costs related to the Project, which Project is expected to be placed  
19 into service during Period II, or the proformed rate-effective period, of that general base  
20 rate proceeding. Under the current schedule for the Project, assuming regulatory approval  
21 in early 2018, all of the individual solar PV systems are expected to be installed by the  
22 end of 2018. For any costs of the Project incurred beyond the referenced rate-effective  
23 period, the Company expects to request recovery through an applicable capacity rider

1           and/or any formula rate plan (“FRP”) authorized as a result of the 2018 rate base  
2           proceeding. Anticipated first-year O&M expenses for the Project would also be  
3           proformed into the 2018 general rate case. Any change in the level of ongoing O&M  
4           expenses subject to the rate-effective period of the 2018 base rate proceeding would be  
5           addressed in subsequent FRP proceedings or, in the event an FRP is not adopted following  
6           the next general rate case, in any applicable capacity rider.

7

8   Q14.   DOES THIS CONCLUDE YOUR DIRECT TESTIMONY?

9   A.     Yes, at this time.

**AFFIDAVIT**

**STATE OF LOUISIANA**

**PARISH OF ORLEANS**

**NOW BEFORE ME**, the undersigned authority, personally came and appeared,  
**Orlando Todd**, who after being duly sworn by me, did depose and say:

That the above and foregoing is his sworn testimony in this proceeding and that he knows the contents thereof, that the same are true as stated, except as to matters and things, if any, stated on information and belief, and that as to those matters and things, he verily believes them to be true.

  
\_\_\_\_\_  
Orlando Todd

**SWORN TO AND SUBSCRIBED BEFORE ME**  
**THIS 4<sup>th</sup> DAY OF OCTOBER, 2017**

  
\_\_\_\_\_  
**NOTARY PUBLIC**  
My commission expires: at death

**Harry M. Barton**  
**Notary Public**  
**Notary ID# 90845**  
**Parish of Orleans, State of Louisiana**  
**My Commission is for Life**

**List of Previous Testimony Filed by Orlando Todd**

<b><u>DATE</u></b>	<b><u>TYPE</u></b>	<b><u>SUBJECT MATTER</u></b>	<b><u>REGULATORY BODY</u></b>	<b><u>DOCKET NO.</u></b>
07/31/2008	Direct Testimony	Rate Case	CNO	UD-08-03
09/15/2008	Direct Testimony	Rate Case	CNO	UD-08-03
10/22/2008	Deposition	Rate Case	CNO	UD-08-03
07/08/2011	Direct Testimony	Revenue Requirement for NineMile 6	CNO	UD-11-03
01/31/2013	Direct Testimony	Rate Case	CNO	UD-08-03
06/07/2013	Rebuttal Testimony	Rate Case	CNO	UD-08-03
02/28/2014	Direct Testimony	Algiers Hurricane Isaac Storm Recovery	CNO	UD-14-01
10/30/2014	Direct Testimony	Algiers Asset Transfer	CNO	UD-14-02
02/09/2015	Direct Testimony	Union Power PPA	CNO	UD-15-01
06/22/2016	Direct Testimony	New Orleans Power Station	CNO	UD-16-02
10/18/2016	Direct Testimony	Advance Metering Infrastructure	CNO	UD-16-04

**BEFORE THE  
COUNCIL OF THE CITY OF NEW ORLEANS**

**APPLICATION OF ENTERGY NEW ORLEANS, INC. )  
FOR APPROVAL TO CONSTRUCT DISTRIBUTED )  
GENERATION-SCALE SOLAR PHOTOVOLTAIC )  
SYSTEMS AND REQUEST FOR COST RECOVERY ) DOCKET NO. UD-17-\_\_  
AND RELATED RELIEF )**

**EXHIBIT OT-2**

**HIGHLY SENSITIVE  
PROTECTED MATERIAL  
INTENTIONALLY OMITTED**

**OCTOBER 2017**